

Evaluating the ADRF5080 Reflective, Silicon SP8T Switch, 100 MHz to 20 GHz

**FEATURES**

- ▶ Full-featured evaluation board for the [ADRF5080](#)
- ▶ Easy connection to test equipment
- ▶ Additional through line for calibration

**EQUIPMENT NEEDED**

- ▶ DC power supplies
- ▶ Network analyzer

**GENERAL DESCRIPTION**

The ADRF5080 is a reflective, SP8T switch manufactured in the silicon on insulator (SOI) process.

This user guide describes the ADRF5080-EVALZ evaluation board, which is designed to simply evaluate the features and performance of the ADRF5080. A photograph of the evaluation board is shown in [Figure 1](#).

Full specifications for the ADRF5080 are available in the ADRF5080 data sheet, which must be consulted when using the ADRF5080-EVALZ.

**EVALUATION BOARD PHOTOGRAPH**

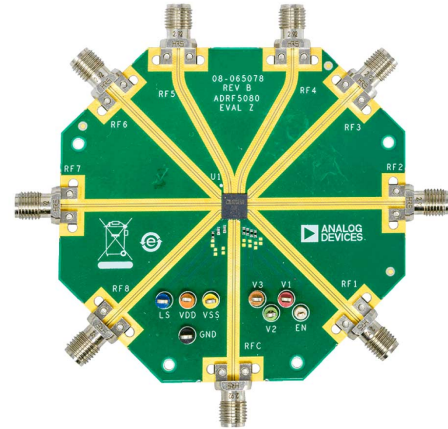

Figure 1. ADRF5080-EVALZ

001

**TABLE OF CONTENTS**

Features.....	1	RF Inputs and Outputs .....	4
Equipment Needed.....	1	Test Procedure.....	5
General Description.....	1	Biasing Sequence.....	5
Evaluation Board Photograph.....	1	Expected Results for the <a href="#">ADRF5080</a> .....	7
Evaluation Board Hardware.....	3	Evaluation Board Schematic and Artwork.....	8
Overview.....	3	Ordering Information.....	9
Board Layout.....	3	Bill of Materials.....	9
Power Supply and Control Inputs.....	3		

**REVISION HISTORY****7/2023—Revision 0: Initial Version**

## EVALUATION BOARD HARDWARE

### OVERVIEW

The ADRF5080-EVALZ is a connectorized board, assembled with the [ADRF5080](#) and its application circuitry. All components are placed on the primary side of the ADRF5080-EVALZ. An assembly drawing for the ADRF5080-EVALZ is shown in [Figure 10](#), and an evaluation board schematic is shown in [Figure 9](#).

### BOARD LAYOUT

The ADRF5080-EVALZ is designed using RF circuit design techniques on a 4-layer printed circuit board (PCB). The PCB stack-up is shown in [Figure 2](#).

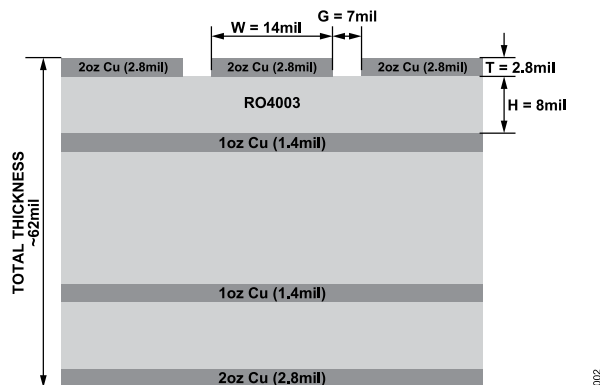

Figure 2. Evaluation Board Stack-Up

The outer copper layers are 2 oz (2.8 mil) thick and the inner layers are 1 oz (1.4 mil) thick.

The top dielectric material is 8 mil Rogers 4003, which provides 50  $\Omega$  controlled impedance and optimizes the high-frequency performance. All RF traces are routed on the top layer, and the second layer is used as the ground plane for RF transmission lines. The remaining two layers are also ground planes filled with FR4 material to manage the thermal rise during high-power operations and are supported with dense and filled vias to the PCB bottom for thermal relief. The overall board thickness is approximately 62 mil for mechanical strength.

The RF transmission lines are designed using a coplanar waveguide (CPWG) model with a width of 14 mil and ground spacing of 7 mil to have a characteristic impedance of 50  $\Omega$ . Ground via fences are arranged on both sides of the CPWG to improve isolation between nearby RF lines and other signal lines.

The exposed ground pad of the ADRF5080, which is soldered on the PCB ground pad, is the main thermal conduit for heat dissipation. The PCB ground pad is densely populated with filled, through vias to provide the lowest possible thermal resistance path from the top to the bottom of the PCB. The connections from the package ground leads to ground are kept as short as possible.

### POWER SUPPLY AND CONTROL INPUTS

The ADRF5080-EVALZ has two power-supply inputs, four control inputs, and a ground, as shown in [Table 1](#). The DC test points are populated on VDD, VSS, V1, V2, V3, LS, EN, and GND. A 3.3 V supply is connected to the DC test point on VDD, and the -3.3 V supply is connected to the DC test point on VSS. Ground reference can be connected to GND. Connect the control inputs, V1, V2, V3, LS, and EN, to 3.3 V or 0 V. The typical total current consumption for the ADRF5080 is 0.80 mA.

The VDD and VSS supply pins and control pins of the ADRF5080 are decoupled with 100 pF capacitor.

Table 1. Power Supply and Control Inputs

Test Point	Description
VDD	+3.3 V supply voltage
VSS	-3.3 V supply voltage
V1	Control Input 1
V2	Control Input 2
V3	Control Input 3
EN	Enable
LS	Logic select
GND	Ground

EVALUATION BOARD HARDWARE

RF INPUTS AND OUTPUTS

The ADRF5080-EVALZ has five edge-mounted, 2.92 mm connectors for the RF inputs and outputs, as shown in Table 2.

Table 2. RF Inputs and Outputs

SMA Connector	Description
RFC	RF common port
RF1	RF Throw Port 1
RF2	RF Throw Port 2
RF3	RF Throw Port 3
RF4	RF Throw Port 4
RF5	RF Throw Port 5
RF6	RF Throw Port 6
RF7	RF Throw Port 7
RF8	RF Throw Port 8

The ADRF5080-EVALZ is shipped together with a through line that calibrates out the board loss effects from the measurements determining the device performance at the pins of the IC. Figure 3 shows the typical board loss for the ADRF5080-EVALZ at room temperature, as well as the embedded and de-embedded insertion loss for the ADRF5080.

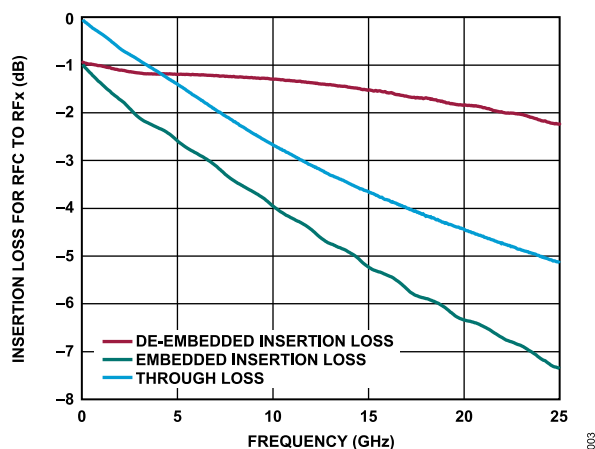

Figure 3. Insertion Loss for RFC to RFx vs. Frequency

## TEST PROCEDURE

### BIASING SEQUENCE

To bias up the ADRF5080-EVALZ, perform the following steps:

1. Ground the GND test point.
2. Bias up the VDD test point.
3. Bias up the VSS test point.
4. Bias up the V1, V2, V3, LS, and EN test points.
5. Apply an RF input signal.

The ADRF5080-EVALZ is shipped fully assembled and tested. [Figure 4](#) provides a basic test setup diagram to evaluate the s-parameters using a network analyzer. Perform the following steps to complete the test setup and to verify the operation of the ADRF5080-EVALZ:

1. Connect the GND test point to the ground terminal of the power supply.
2. Connect the VDD test point to the voltage output terminal of the 3.3 V supply.
3. Connect the VSS test point to the voltage output terminal of the  $-3.3$  V supply. Note that the current from VDD test point is around  $220 \mu\text{A}$  and from VSS test point is around  $580 \mu\text{A}$ .
4. Connect the V1, V2, EN, and LS test points to the voltage output terminal of the 3.3 V supply. The [ADRF5080](#) can be configured in different modes by connecting the control test points to 3.3 V or 0 V, as shown in [Table 3](#).
5. Connect a calibrated network analyzer to the RFC, RF1, RF2, RF3, RF4, RF5, RF6, RF7, and RF8 2.92 mm connectors. If the

network analyzer port count is not enough, terminate unused RF ports with  $50 \Omega$ . Sweep the frequency from 100 MHz to 20 GHz and set the power to  $-5$  dBm.

6. The ADRF5080-EVALZ is expected to have an insertion loss of 2.00 dB at 20 GHz. See the expected results in [Figure 5](#).

Additional test equipment is needed to fully evaluate the device functions and performance.

For third-order intercept point evaluation, use two signal generators and a spectrum analyzer. A high isolation power combiner is also recommended.

For power compression and power handling evaluations, use a 2-channel power meter and a signal generator. A high enough power amplifier is also recommended at the input. Test accessories, such as couplers and attenuators, must have enough power handling.

The ADRF5080-EVALZ comes with a support plate attached to the bottom side. To ensure maximum heat dissipation and to reduce thermal rise on the board during high power evaluations, this support plate must be attached to a heat sink using thermal grease.

Note that the measurements performed at the 2.92 mm connectors of the ADRF5080-EVALZ include the losses of the 2.92 mm connectors and the PCB. The through line must be measured to calibrate out the effects on the ADRF5080-EVALZ. The through line is the summation of an RF input line and an RF output line that are connected to the device and equal in length.

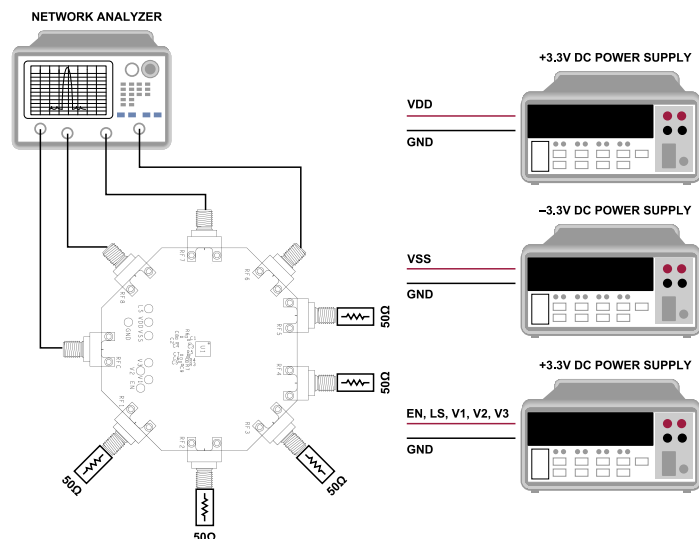

Figure 4. Test Setup Diagram

**TEST PROCEDURE**

**Table 3. Control Voltage Truth Table**

Digital Control Inputs					RFx Paths							
EN	LS	V3	V2	V1	RF1 to RFC	RF2 to RFC	RF3 to RFC	RF4 to RFC	RF5 to RFC	RF6 to RFC	RF7 to RFC	RF8 to RFC
Low	Low	Low	Low	Low	On	Off	Off	Off	Off	Off	Off	Off
Low	Low	Low	Low	High	Off	On	Off	Off	Off	Off	Off	Off
Low	Low	Low	High	Low	Off	Off	On	Off	Off	Off	Off	Off
Low	Low	Low	High	High	Off	Off	Off	On	Off	Off	Off	Off
Low	Low	High	Low	Low	Off	Off	Off	Off	On	Off	Off	Off
Low	Low	High	Low	High	Off	Off	Off	Off	Off	On	Off	Off
Low	Low	High	High	Low	Off	Off	Off	Off	Off	Off	On	Off
Low	Low	High	High	High	Off	Off	Off	Off	Off	Off	Off	On
Low	High	Low	Low	Low	Off	Off	Off	Off	Off	Off	Off	On
Low	High	Low	Low	High	Off	Off	Off	Off	Off	Off	On	Off
Low	High	Low	High	Low	Off	Off	Off	Off	Off	On	Off	Off
Low	High	Low	High	High	Off	Off	Off	Off	On	Off	Off	Off
Low	High	High	Low	Low	Off	Off	Off	On	Off	Off	Off	Off
Low	High	High	Low	High	Off	Off	On	Off	Off	Off	Off	Off
Low	High	High	High	Low	Off	On	Off	Off	Off	Off	Off	Off
Low	High	High	High	High	On	Off	Off	Off	Off	Off	Off	Off
High	Low or high	Low or high	Low or high	Low or high	Off	Off	Off	Off	Off	Off	Off	Off

TEST PROCEDURE

EXPECTED RESULTS FOR THE ADRF5080

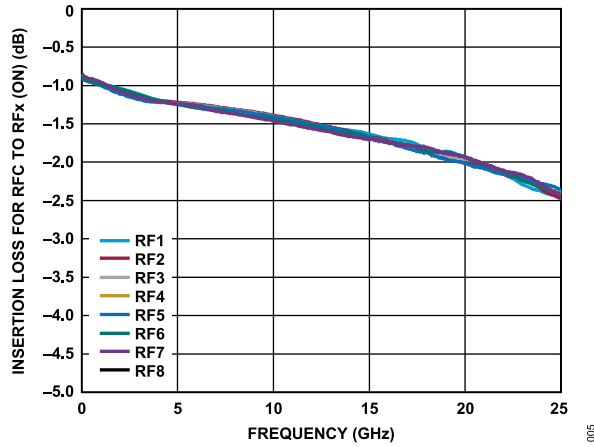

Figure 5. Insertion Loss for RFC to RFX (On) vs. Frequency

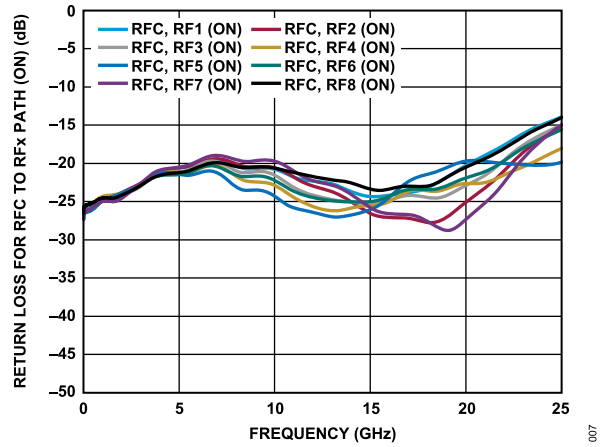

Figure 7. Return Loss for RFC to RFX Path (On) vs. Frequency

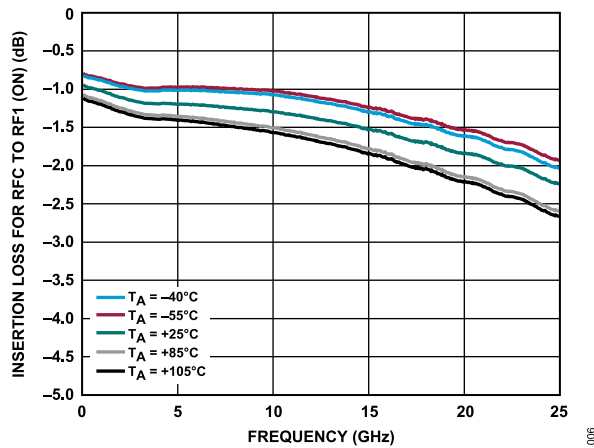

Figure 6. Insertion Loss for RFC to RF1 (On) vs. Frequency over Various Temperatures

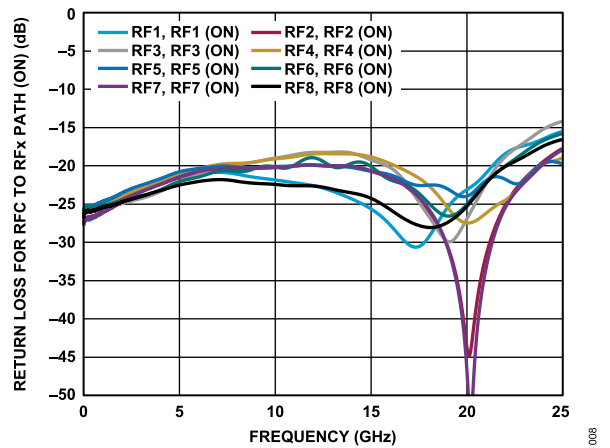

Figure 8. Return Loss for RFC to RFX Path (On) vs. Frequency

EVALUATION BOARD SCHEMATIC AND ARTWORK

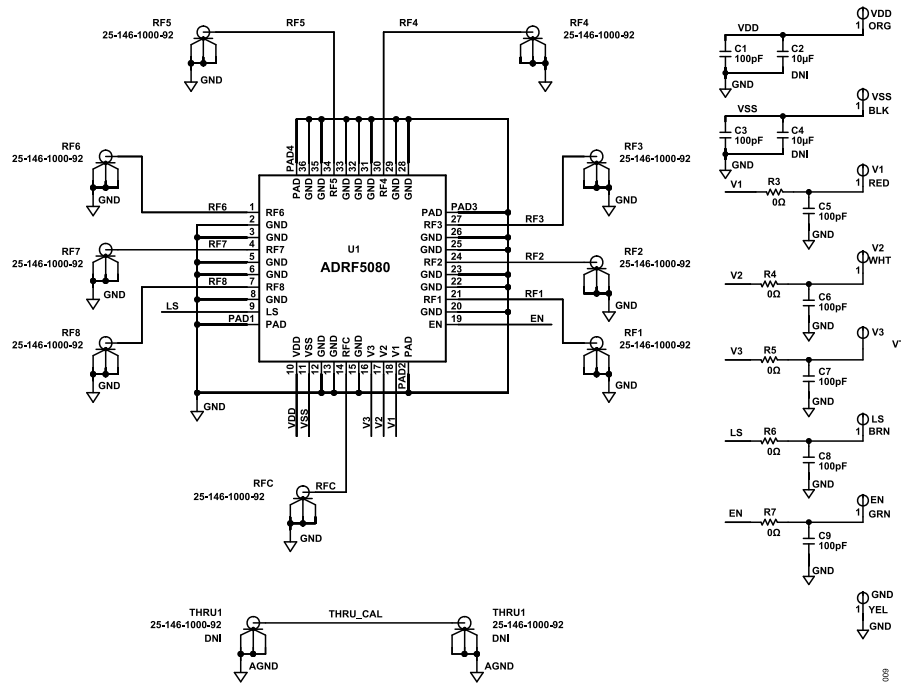

Figure 9. ADRF5080-EVALZ Evaluation Board Schematic

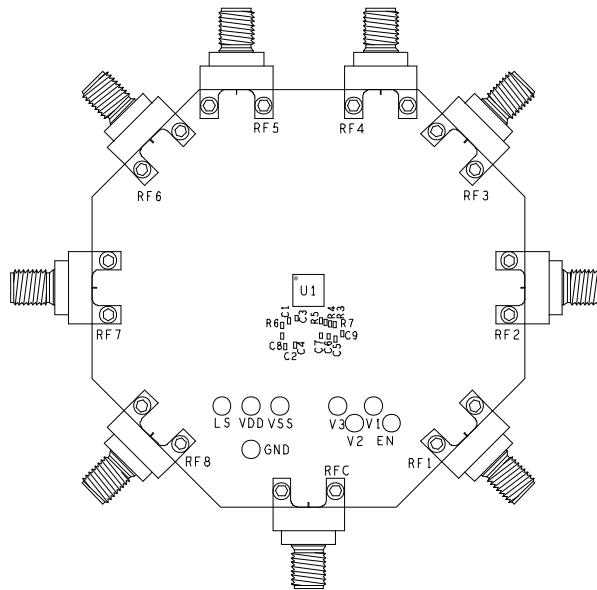

Figure 10. ADRF5080-EVALZ Evaluation Board Assembly Diagram



## ORDERING INFORMATION

## BILL OF MATERIALS

Qty	Reference Designator	Description	Manufacturer	Part Number
7	C1, C3, C5, C6, C7, C8, C9	Capacitors, 100 pF, 50 V, C0402 package	TDK	C1005NP01H101J050BA
5	R3, R4, R5, R6, R7	Resistors, 0 Ω, 1/10 W, R0402 package	Panasonic	ERJ-2GE0R00X
9	RF1, RF2, RF3, RF4, RF5, RF6, RF7, RF8, RFC	Edge-mount 2.92 mm connectors	SRI Connector Gage Co.	25-146-1000-92
8	EN, V1, V2, V3, GND, LS, VDD, VSS	Surface-mount test points	Components Corporation	TP-104-01-0x
1	U1	Reflective, silicon SP8T switch, 100 MHz to 20 GHz	Analog Devices, Inc.	<a href="#">ADRF5080</a>
1	PCB	ADRF5080-EVALZ	Analog Devices	

**ESD Caution**

**ESD (electrostatic discharge) sensitive device.** Charged devices and circuit boards can discharge without detection. Although this product features patented or proprietary protection circuitry, damage may occur on devices subjected to high energy ESD. Therefore, proper ESD precautions should be taken to avoid performance degradation or loss of functionality.

**Legal Terms and Conditions**

By using the evaluation board discussed herein (together with any tools, components documentation or support materials, the "Evaluation Board"), you are agreeing to be bound by the terms and conditions set forth below ("Agreement") unless you have purchased the Evaluation Board, in which case the Analog Devices Standard Terms and Conditions of Sale shall govern. Do not use the Evaluation Board until you have read and agreed to the Agreement. Your use of the Evaluation Board shall signify your acceptance of the Agreement. This Agreement is made by and between you ("Customer") and Analog Devices, Inc. ("ADI"), with its principal place of business at Subject to the terms and conditions of the Agreement, ADI hereby grants to Customer a free, limited, personal, temporary, non-exclusive, non-sublicensable, non-transferable license to use the Evaluation Board FOR EVALUATION PURPOSES ONLY. Customer understands and agrees that the Evaluation Board is provided for the sole and exclusive purpose referenced above, and agrees not to use the Evaluation Board for any other purpose. Furthermore, the license granted is expressly made subject to the following additional limitations: Customer shall not (i) rent, lease, display, sell, transfer, assign, sublicense, or distribute the Evaluation Board; and (ii) permit any Third Party to access the Evaluation Board. As used herein, the term "Third Party" includes any entity other than ADI, Customer, their employees, affiliates and in-house consultants. The Evaluation Board is NOT sold to Customer; all rights not expressly granted herein, including ownership of the Evaluation Board, are reserved by ADI. CONFIDENTIALITY. This Agreement and the Evaluation Board shall all be considered the confidential and proprietary information of ADI. Customer may not disclose or transfer any portion of the Evaluation Board to any other party for any reason. Upon discontinuation of use of the Evaluation Board or termination of this Agreement, Customer agrees to promptly return the Evaluation Board to ADI. ADDITIONAL RESTRICTIONS. Customer may not disassemble, decompile or reverse engineer chips on the Evaluation Board. Customer shall inform ADI of any occurred damages or any modifications or alterations it makes to the Evaluation Board, including but not limited to soldering or any other activity that affects the material content of the Evaluation Board. Modifications to the Evaluation Board must comply with applicable law, including but not limited to the RoHS Directive. TERMINATION. ADI may terminate this Agreement at any time upon giving written notice to Customer. Customer agrees to return to ADI the Evaluation Board at that time. LIMITATION OF LIABILITY. THE EVALUATION BOARD PROVIDED HEREUNDER IS PROVIDED "AS IS" AND ADI MAKES NO WARRANTIES OR REPRESENTATIONS OF ANY KIND WITH RESPECT TO IT. ADI SPECIFICALLY DISCLAIMS ANY REPRESENTATIONS, ENDORSEMENTS, GUARANTEES, OR WARRANTIES, EXPRESS OR IMPLIED, RELATED TO THE EVALUATION BOARD INCLUDING, BUT NOT LIMITED TO, THE IMPLIED WARRANTY OF MERCHANTABILITY, TITLE, FITNESS FOR A PARTICULAR PURPOSE OR NON-INFRINGEMENT OF INTELLECTUAL PROPERTY RIGHTS. IN NO EVENT WILL ADI AND ITS LICENSORS BE LIABLE FOR ANY INCIDENTAL, SPECIAL, INDIRECT, OR CONSEQUENTIAL DAMAGES RESULTING FROM CUSTOMER'S POSSESSION OR USE OF THE EVALUATION BOARD, INCLUDING BUT NOT LIMITED TO LOST PROFITS, DELAY COSTS, LABOR COSTS OR LOSS OF GOODWILL. ADI'S TOTAL LIABILITY FROM ANY AND ALL CAUSES SHALL BE LIMITED TO THE AMOUNT OF ONE HUNDRED US DOLLARS (\$100.00). EXPORT. Customer agrees that it will not directly or indirectly export the Evaluation Board to another country, and that it will comply with all applicable United States federal laws and regulations relating to exports. GOVERNING LAW. This Agreement shall be governed by and construed in accordance with the substantive laws of the Commonwealth of Massachusetts (excluding conflict of law rules). Any legal action regarding this Agreement will be heard in the state or federal courts having jurisdiction in Suffolk County, Massachusetts, and Customer hereby submits to the personal jurisdiction and venue of such courts. The United Nations Convention on Contracts for the International Sale of Goods shall not apply to this Agreement and is expressly disclaimed.

