

TMCM-142-IF

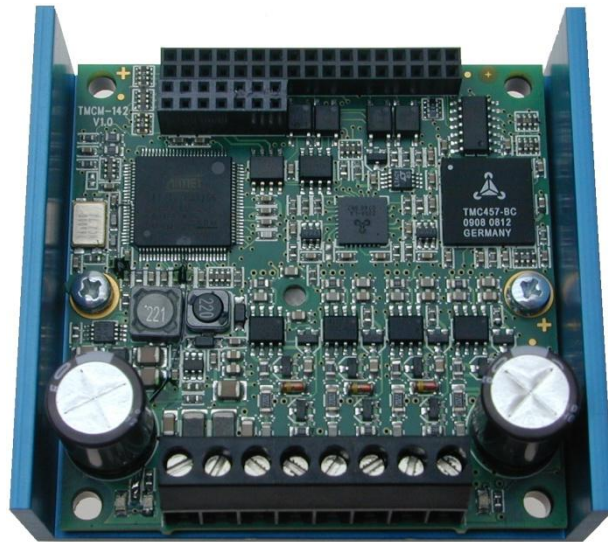

Hardware Manual

Version: 1.01
2009-JUL-31



Trinamic Motion Control GmbH & Co KG
Sternstraße 67
D - 20 357 Hamburg, Germany
<http://www.trinamic.com>

Table of Contents

1	Life support policy.....	3
2	Features.....	4
3	Order codes.....	5
4	Mechanical and electrical interfacing	6
4.1	Size of unit	6
4.2	Connectors	7
4.3	Connecting the module	7
4.4	Base connector 1: power supply and motor connection	8
4.4.1	Base connector 2: USB, RS232, CAN and SPI	8
4.4.2	Base connector 3: I/Os.....	9
5	Functional description	10
5.1	TMC-IF add-on board	10
5.2	System architecture (base).....	10
5.2.1	Microcontroller (ARM7).....	10
5.2.2	TMCL/configuration EEPROM.....	11
5.2.3	TMC457 motion controller	11
5.2.4	TMC239 motor driver.....	11
5.3	Power supply requirements.....	11
5.4	Communication interfaces.....	12
5.5	Encoder interface	12
5.6	Reference switches.....	12
6	Operational ratings.....	13
7	Revision history.....	14
7.1	Documentation revision.....	14
7.2	Hardware revision.....	14
8	References	15

1 Life support policy

TRINAMIC Motion Control GmbH & Co. KG does not authorize or warrant any of its products for use in life support systems, without the specific written consent of TRINAMIC Motion Control GmbH & Co. KG.

Life support systems are equipment intended to support or sustain life, and whose failure to perform, when properly used in accordance with instructions provided, can be reasonably expected to result in personal injury or death.

© TRINAMIC Motion Control GmbH & Co. KG 2009

Information given in this data sheet is believed to be accurate and reliable. However neither responsibility is assumed for the consequences of its use nor for any infringement of patents or other rights of third parties, which may result from its use.

Specifications are subject to change without notice.

2 Features

The TMC457 is a high-performance single axis stepper motor controller/driver with encoder feedback. It offers an aluminum U-shaped profile for protection and easy mounting. The integrated TMC457 motion controller provides superior performance with regard to microstep resolution (up-to 1024), maximum velocity (integrated chopsync™), ramp calculation (S-shaped ramps, calculated in real-time) and encoder feedback support (closing the loop in hardware with PID regulator). The driver stage supports motors with up-to 5A RMS coil current and offers exceptional low power dissipation.

Together with the TMC457-IF standard add-on interface/adaptor board a large number of interface options is available.

Applications

- Compact high-resolution/high-performance stepper motor controller/driver solutions
- Smooth movements with high microstep resolution and S-shaped ramps
- High precision and high repeatability with encoder feedback and PID position regulator

Electrical data

- Supply voltage: +18V... +78.5V DC
- Motor current: up-to 7A peak / 5A RMS (programmable)

Supported motors

- Two phase bipolar motors with 1A to 5A RMS coil current
- Incremental encoder (a/b + optional index channel, differential, open-collector or single ended signals)

Interfaces

- Optically isolated inputs for home and stop switches
- general purpose analogue and digital inputs and outputs
- RS422, RS232, CAN and USB serial interfaces available
- RS422, RS485, RS232, CAN or USB serial interfaces available on standard add-on interface board TMC457-IF

Features

- 1024 times micro stepping
- Automatic ramp generation (trapezoid and S-shaped) in real-time in hardware
- On the fly alteration of motion parameters (e.g. position, velocity, acceleration)
- Uses TMC457 high performance controller
- Chopsync™ for high speed
- High-efficient operation, low power dissipation
- Integrated protection: overtemperature/undervoltage

Software

- Stand-alone operation using TMCL or remote controlled operation
- Memory for 2048 TMCL commands
- PC-based application development software TMCL-IDE included
- CANopen ready

3 Order codes

The TMC-142 is currently available with the standard adapter/interface add-on board TCM-IF:

Order code	Description	Dimensions [mm ³]
TMC-142-IF	Single axis stepper motor controller/driver, 5A RMS, 75V, with encoder feedback and the standard adapter/interface board TCM-IF	76 x 70 x 33

Table 3.1: Order codes

Versions without the standard adapter/interface board TCM-IF (just the baseboard) or custom interface boards are available on request.

4 Mechanical and electrical interfacing

4.1 Size of unit

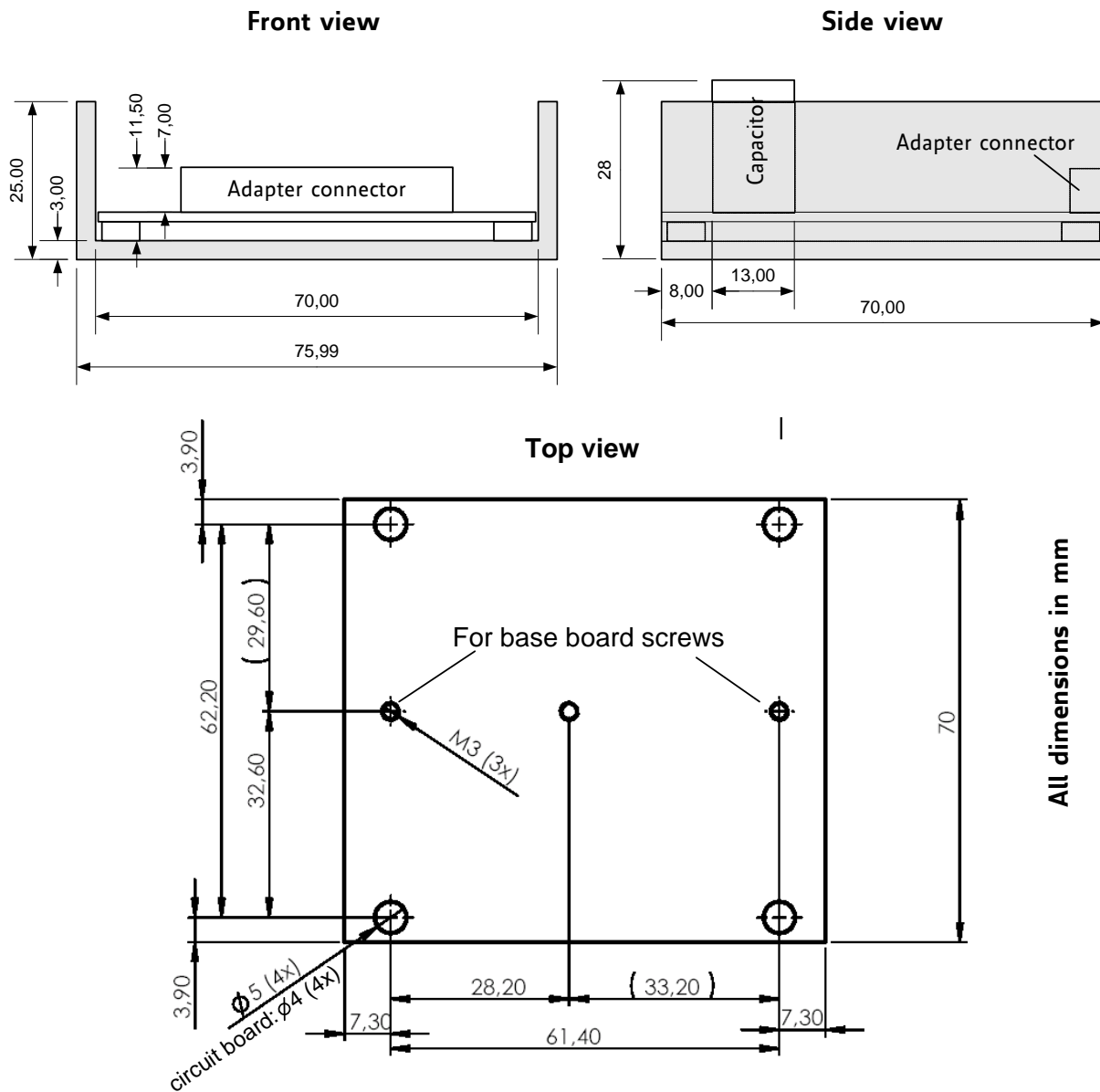

Figure 4.1: Dimensions

The maximum height of the base board is 28mm including capacitors.

In combination with the standard add-on adapter/interface board TMCM-IF the overall height will increase to 33mm. Additional space might be required for connectors being attached.

For mounting the unit on a base plate use four M4 screws. Please avoid using screws with a head diameter of more than 7mm as this might damage the electronics on the base board.

4.2 Connectors

The following connectors are available:

Connector 1: 1x8 pin, 5mm pitch screw connector

Connector 2: 2x7 pin, 2.54mm pitch, two row female header connector

Connector 3: 2x17 pin, 2.54mm pitch, two row female header connector

For the TCM-IF add-on board please check separate standard adapter/interface board documentation [TCM-IF].

4.3 Connecting the module

The TCM-142-IF module consists of two PCBs, the TCM-142 base board and the standard TCM-IF adapter/interface add-on board.

Attention: Never connect or disconnect base and adapter board while the unit is powered on!

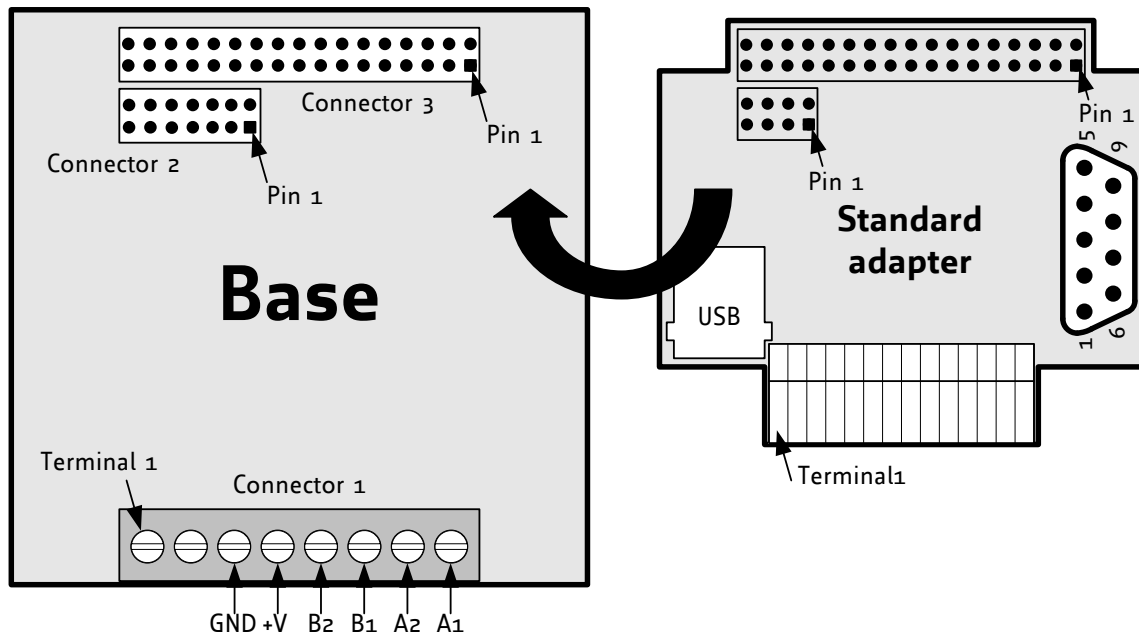



Figure 4.2: Connectors of the TCM-142

4.4 Base connector 1: power supply and motor connection

Attention: Never connect or disconnect the motor while the unit is powered on!



Pin	Label	Description
1	NC	Not connected
2	NC	Not connected
3	GND	Supply ground
4	+V	Supply Voltage
5	B 2	Motor connection, Coil B
6	B 1	Motor connection, Coil B
7	A 2	Motor connection, Coil A
8	A 1	Motor connection, Coil A

Table 4.1: Base connector 1 - power supply and motor connection

4.4.1 Base connector 2: USB, RS232, CAN and SPI

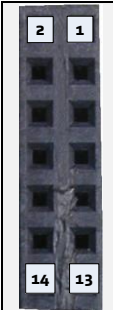

Pin	Label	Description	Pin	Label	Description
1	USB+	Positive USB line	2	USB_MON	Input for monitoring USB +5V supply
3	USB-	Negative USB line	4	USB_PU	Output for activating USB pull-up resistor
5	RS232_RxD	RS232 receive data input	6	RS232_TxD	RS232 transmit data output
7	CANH	Positive CAN line	8	SPI_MISO	SPI input
9	CANL	Negative CAN line	10	SPI_MOSI	SPI output
11	GND	Ground	12	SPI_CLK	Clock output
13	+5V	+5V supply output	14	CS_EXT	Chip select output line

External SPI Interface for GPIO extensions

Table 4.2: Base connector 2 – USB, RS232, CAN and SPI

4.4.2 Base connector 3: I/Os



Pin	Name	Function	PIN	Name	Function
1	TX-	RS422 transmit data out -	2	TX+	RS422 transmit data out +
3	RX-	RS422 Receive data in -	4	RX+	RS422 Receive data in +
5			6	ADIN_o	Analog user controlled input #1. No internal resistors.
7	REF R	Optically isolated, active low limit switch input "Right"	8	STEP_OUT/RXD	Step clock output from indexer RS232 option: RS232 receive
9	OUT_1	User controlled output #2. No internal resistors.	10	DIR_OUT/TXD	Direction output from indexer. RS232 option: RS232 transmit
11	IN_7	Digital user controlled input #8. Optically isolated, active low (needs power supply on pin 15)	12	ENC_A-	Differential encoder: Channel A- input
13	ADIN_2	Analog user controlled input #3. No internal resistors.	14	ENC_B-	Differential encoder: Channel B- input
15	+5V	DC bias for input optocouplers	16	+5VDC	Supply voltage output for encoder
17	OUT_0	User controlled output #1. No internal resistors.	18	ENC_N-	Differential encoder: Channel N- input
19	REF L	Optically isolated, active low limit switch input "Left"	20	GND	Logic supply ground connection
21	IN_3	Digital user controlled input #4. No internal resistors. (TTL)	22	OUT_2	User controlled output #3. No internal resistors.
23	IN_8 (Home)	Digital user controlled input #9. Optically isolated, active low (power supply on pin 15)	24		
25	IN_5	Digital user controlled input #6. No internal resistors. (TTL)	26	ADIN_1	Analog user controlled input #2. No internal resistors.
27	ALARM	High voltage open collector output indicating driver fault condition.	28		
29	ENC_N+	Encoder option: Single ended: Channel N input Differential: Channel N+ input	30	IN_6	Digital user controlled input #7. No internal resistors. (TTL)
31	FS	Active for one clock pulse at each on-pole fullstep position.	32	IN_4	Digital user controlled input #5. No internal resistors. (TTL)
33	ENC_B+	Encoder option: Single ended: Channel B input Differential: Channel B+ input	34	ENC_A+	Encoder option: Single ended: Channel A input Differential: Channel A+ input

Table 4.3: Base connector 3 - I/Os

5 Functional description

In Figure 5.1 the main parts of the TCMC-142 module are shown. The module mainly consists of an ARM7 microcontroller, the TMC457 motion controller, the TMC239 stepper motor driver, the configuration and TMCL program memory (EEPROM) and the host interfaces (CAN, USB, RS232 or RS422).

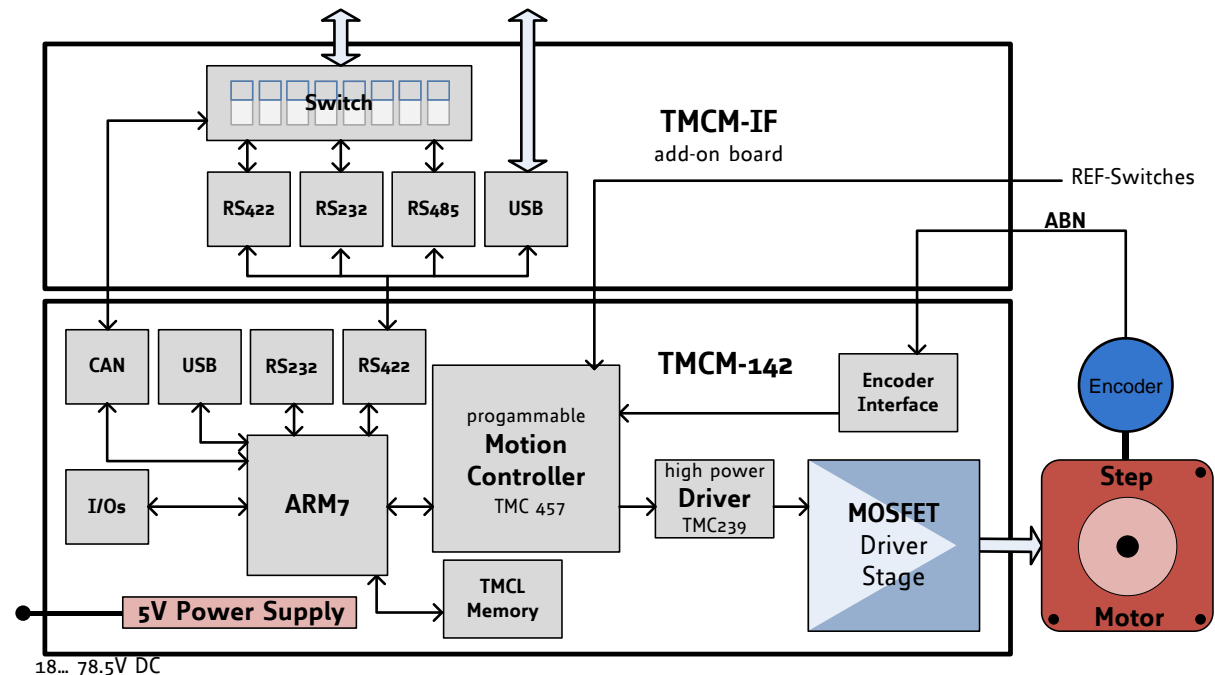

Figure 5.1: Main parts of TCMC-142 with TCMC-IF

5.1 TCMC-IF add-on board

The TCMC-IF standard adapter/interface board supports easy access via standard connectors to many of the signals available on the two row female headers on the TCMC-142 baseboard. The standard adapter board provides four interface variants: RS422, RS232, CAN, RS485, and USB. All interfaces can be configured via on-board dip switches. Furthermore, it offers 14 easily accessible I/Os (limit switches, encoder interface, etc). Please refer to the documentation of the TCMC-IF for more information.

5.2 System architecture (base)

The TCMC-142 contains an ARM7 microcontroller for communication protocol handling and overall system control. All motion control real-time tasks are processed by the TMC457 in hardware.

5.2.1 Microcontroller (ARM7)

The flash memory of the ARM7 microcontroller contains a bootloader and the firmware itself. While the bootloader normally remains untouched throughout the lifetime of the unit, the firmware might be updated using one of the serial communication interfaces. The firmware might contain e.g. the TMCL interpreter or the CANopen software.

5.2.2 TMCL/configuration EEPROM

For storing TMCL programs for stand-alone operation the TMCM-142 is equipped with a 16kByte EEPROM attached to the microcontroller. The EEPROM can store TMCL programs consisting of up-to 2048 TMCL commands. In addition, the EEPROM might be used for storing configuration data (also with other firmware options e.g. CANopen).

5.2.3 TMC457 motion controller

The TMC457 is a high-end single axis micro stepping motion controller for 2-phase bipolar stepper motors. It is intended for applications, where a precise and fast, jerk-free motion profile is desired. The TMC457 supports linear and S-shaped velocity ramps. Its chopSync™ feature allows high speed movement avoiding resonances. An encoder can be added for extremely quick and precise positioning (using the internal hardware PID regulator easyPID™) and for increased reliability/fault detection. For a maximum flexibility you can change all motion control parameters (target position, target velocity, acceleration, deceleration and bow) on-the-fly at any time during motion.

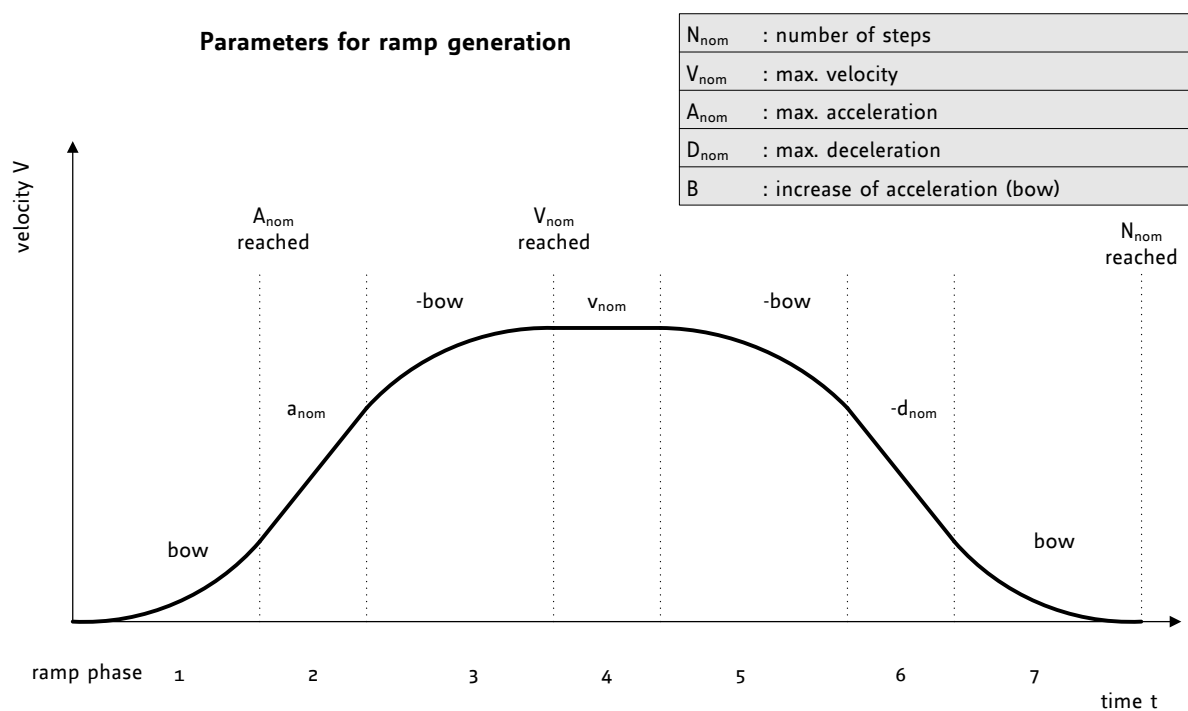

Figure 5.2: Parameters for ramp generation

5.2.4 TMC239 motor driver

The stepper motor driver used on the TMCM-142 is the TMC239 smart high current microstepping driver for bipolar stepper motors. It offers diagnostics

5.3 Power supply requirements

The TMCM-142 is equipped with two switching voltage regulators and a number of linear regulators for generating the required on-board voltages of the module. Therefore, only one power supply voltage is required for this module. A supply voltage between 18 to 78.5V DC may be supplied to the module.

Please note, that there is no protection against reverse polarity or voltages above the upper maximum limit. The power supply typically should be within a range of 24 to 75V to achieve the highest motor performance.

When using supply voltages near the upper limit, a regulated power supply is mandatory. Please ensure, that enough power filtering capacitors are available in the system (2200 μ F or more recommended) in order to absorb mechanical energy fed back by the motor in stalling conditions. In larger systems a zener diode circuitry might be required in order to limit the maximum voltage when the motor is operated at high velocities.

The power supply should be designed in a way, that it supplies the nominal motor voltage at the desired maximum motor power. **In no case shall the supply value exceed the upper voltage limit.**

To ensure reliable operation of the unit, the power supply has to have a sufficient output capacitor and the supply cables should have a low resistance, so that the chopper operation does not lead to an increased power supply ripple directly at the unit. Power supply ripple due to the chopper operation should be kept at a maximum of a few 100mV.

Guidelines for power supply:

- a) keep power supply cables as short as possible
- b) use large diameters for power supply cables
- c) add 2200 μ F or larger filter capacitors near the motor driver unit especially if the distance to the power supply is large (i.e. more than 2-3m)

5.4 Communication interfaces

The TMCM-142 offers the following serial communication interfaces: CAN, USB, RS232 and RS422. With the standard adapter/interface board an additional RS485 interface is provided. Please check the TMCM-IF manual for additional information.

5.5 Encoder interface

The TMCM-142 provides an interface for single ended incremental encoders with TTL (+5V) outputs, open collector outputs and differential outputs (line termination resistors have to be added externally). Use the encoder inputs A+ ,B+ and (optional) N+ for single ended encoder signals. The other encoder input signals may be left unconnected in that case. The encoder counter can be read by software and can be used to control the exact positioning of the motor. Closed loop operation is possible via the internal PID regulator of the TMC457.

A +5V DC supply voltage is provided for the encoder.

5.6 Reference switches

Two digital reference/stop switch inputs are provided (REF L= stop left and REF R = stop right). They are used as an absolute position reference for homing and to set a hardware limit for the motion range. Also a step loss of the system can be detected, e.g. due to overloading or manual interaction, by using a travel-switch. The inputs are optically isolated, active low, and use TTL levels.

6 Operational ratings

The operational ratings show the intended or the characteristic range of values and should be used as design values.

In no case shall the maximum values be exceeded!

Symbol	Parameter	Min	Type	Max	Unit
V_{DC}	Power supply voltage for operation	18	24 ... 75	78.5	V
I_{COIL}	Motor coil current for sine wave peak (chopper regulated, adjustable via software)	0	0.7 ... 6.4	7.1	A
I_{MC}	Motor coil current for sine wave RMS	0	0.5 ... 4.5	5.0	A
f_{CHOP}	Motor chopper frequency		36		kHz
I_S	Power supply current		$\ll I_{COIL}$	$1.4 * I_{COIL}$	A
U_{+5V}	+5V output (max. 150mA load)	4.8	5.0	5.2	V
V_{ISO}	Isolation voltage of optocoupler		± 42	± 100	V
I_{OPTON}	Signal current for optocoupler (internal 220Ohm resistor provided)		4	8	mA
V_{ANA}	INx_A/D analog measurement range		0 ... 5 or 3.3		V
V_{INLO}	Input low level	-2	0	0.8	V
V_{INHI}	Input high level (integrated pull-up to +5V)	2.4	5	30	V
T_{ENV}	Environment temperature at rated current (no forced cooling)	-25		+70	°C
	Environment temperature at 80 % of rated current or 50% duty cycle (no forced cooling)	-25		+85	°C

Table 6.1: Operational ratings

7 Revision history

7.1 Documentation revision

Version	Date	Author	Description
1.00	2009-FEB-10	SD	First Version
1.01	2009-JUL-31	SD	I/Os corrected

Table 7.1: Documentation revision

7.2 Hardware revision

Version	Date	Description
1.00	2008-09-22	First 10 prototypes manufactured
1.10	2009-02-10	Series version

Table 7.2: Hardware revision

8 References

[TMC-IF] TMC-IF manual (see <http://www.trinamic.com>)