

## General Description

The MAX38902A/B/C/D are low-noise, linear regulators that deliver up to 500mA of output current with only 10.5 $\mu$ V<sub>RMS</sub> of output noise from 10Hz to 100kHz. These regulators maintain  $\pm 1\%$  output accuracy over a wide input voltage range, requiring only 100mV of input-to-output headroom at full load. The 365 $\mu$ A no-load supply current is independent of dropout voltage. The MAX38902A/B/C/D has an 800 $\Omega$  active discharge feature to quickly discharge output capacitors.

The MAX38902A have nine, pin-selectable output voltages 1.2V, 1.5V, 1.8V, 2.5V, 3.0V, 3.1V, 3.3V, 4.0V, and 5V. The MAX38902B/C have a resistor-adjustable output voltage in the range of 0.6V to 5.3V. The MAX38902B also includes an active-low POK output.

The MAX38902D have factory-preset output voltages ranging from 0.7V to 5V. All versions include a programmable output soft-start rate, output overcurrent, and thermal-overload protection.

The MAX38902A/B are offered in an 8-pin TDFN package, while the MAX38902C/D are offered in a 2 x 3, 0.4mm wafer-level package (WLP).

## Applications

- Communication Circuitry
- Audio Systems
- High-Resolution Data Acquisition Systems

## Benefits and Features

- 1.7V to 5.5V Input Voltage Range
- 0.6V to 5.3V Output Voltage Range
- 10.5 $\mu$ V<sub>RMS</sub> Output Noise, 10Hz to 100kHz
- 365 $\mu$ A Operating Supply Current
- 70dB PSRR at 10kHz
- 500mA Maximum Output Current
- $\pm 1\%$  DC Accuracy over Load, Line, and Temperature
- 100mV (max) Dropout at 500mA Load (3.6V<sub>IN</sub>)
- < 0.1 $\mu$ A Shutdown Supply Current
- Stable with 2 $\mu$ F (min) Output Capacitance
- Active Discharge of 800 $\Omega$  at OUT
- Programmable Soft-Start Rate
- Overcurrent and Overtemperature Protection
- Output-to-Input Reversed Current Protection
- POK Output
- Pin-to-Pin Compatible with MAX8902 (TDFN)
- 1.22mm x 0.82mm, 2 x 3 Bump, 0.4mm Pitch WLP; or 2mm x 2mm, 8-Pin TDFN Package

Typical Operating Circuits

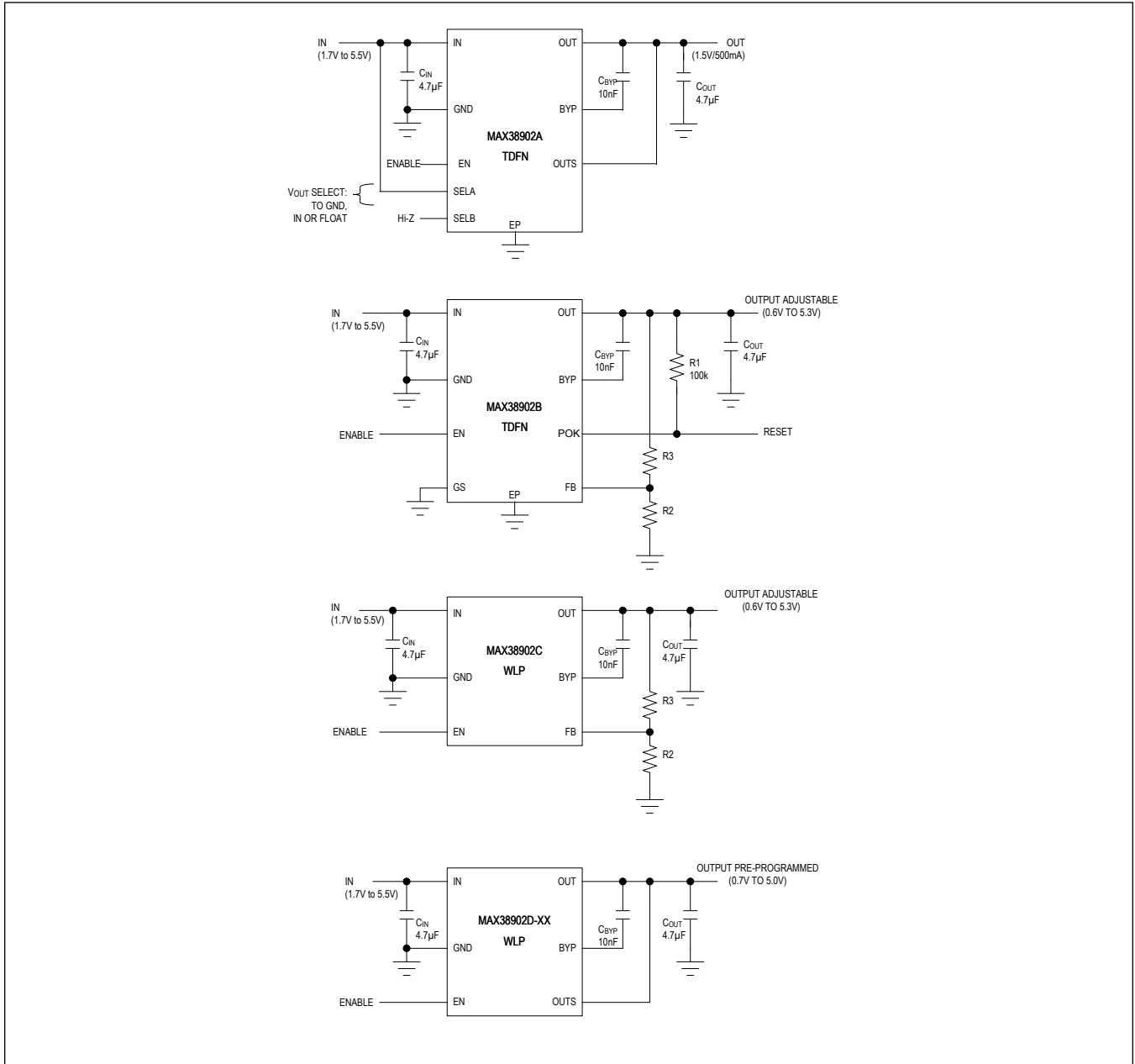

## Absolute Maximum Ratings

IN, EN, POK, SELA, SELB, GS, OUT, OUTS, FB, BYP to GND .....	-0.3V to +6V
Output Short-Circuit Duration .....	Continuous
Continuous Power Dissipation (T <sub>A</sub> = +70°C) WLP (derate 10.5mW/°C above 70°C) .....	840mW
TDFN (derate 9.8mW/°C above 70°C) .....	784mW

Operating Temperature Range .....	-40°C to +125°C
Maximum Junction Temperature .....	+150°C
Storage Temperature Range .....	-65°C to +150°C
Lead Temperature (Soldering, 10 seconds) .....	+300°C
Soldering Temperature (reflow) .....	+260°C

Stresses beyond those listed under "Absolute Maximum Ratings" may cause permanent damage to the device. These are stress ratings only, and functional operation of the device at these or any other conditions beyond those indicated in the operational sections of the specifications is not implied. Exposure to absolute maximum rating conditions for extended periods may affect device reliability.

## Package Information

### TDFN

Package Code	T822+3C
Outline Number	<a href="#">21-0168</a>
Land Pattern Number	<a href="#">90-0065</a>
<b>THERMAL RESISTANCE, SINGLE-LAYER BOARD</b>	
Junction to Ambient ( $\theta_{JA}$ )	130°C/W
Junction to Case ( $\theta_{JC}$ )	8°C/W
<b>THERMAL RESISTANCE, FOUR-LAYER BOARD</b>	
Junction to Ambient ( $\theta_{JA}$ )	102°C/W
Junction to Case ( $\theta_{JC}$ )	8°C/W

### WLP

Package Code	N60G1+1
Outline Number	<a href="#">21-100183</a>
Land Pattern Number	Refer to <a href="#">Application Note 1891</a>
<b>THERMAL RESISTANCE, FOUR-LAYER BOARD</b>	
Junction to Ambient ( $\theta_{JA}$ )	95.1°C/W
Junction to Case ( $\theta_{JC}$ )	N/A

For the latest package outline information and land patterns (footprints), go to [www.maximintegrated.com/packages](http://www.maximintegrated.com/packages). Note that a "+", "#", or "-" in the package code indicates RoHS status only. Package drawings may show a different suffix character, but the drawing pertains to the package regardless of RoHS status.

Package thermal resistances were obtained using the method described in JEDEC specification JESD51-7, using a four-layer board. For detailed information on package thermal considerations, refer to [www.maximintegrated.com/thermal-tutorial](http://www.maximintegrated.com/thermal-tutorial).

### Electrical Characteristics

( $V_{IN} = 3.6V$ ,  $V_{OUT} = 3.3V$ ,  $T_J = -40^{\circ}C$  to  $+125^{\circ}C$ ,  $C_{BYP} = 10nF$ ,  $C_{IN} = 4.7\mu F$ ,  $C_{OUT} = 4.7\mu F$ , [Typical Operating Circuits](#). Typical values are at  $T_J = +25^{\circ}C$ , unless otherwise specified. ([Note 1](#)))

PARAMETER	SYMBOL	CONDITIONS		MIN	TYP	MAX	UNITS
Input Voltage Range	$V_{IN}$	Guaranteed by Output Accuracy		1.7		5.5	V
Input Undervoltage Lockout	$V_{IN\_UVLO}$	$V_{IN}$ rising, 100mV hysteresis		1.5	1.6	1.7	V
Output Voltage Range	$V_{OUT}$	$V_{IN} > V_{OUT} + 0.1V$		0.6		5.3	V
Output Capacitance	$C_{OUT}$	For stability and proper operation		2	4.7		$\mu F$
Supply Current	$I_Q$	$I_{OUT} = 0mA$			365	600	$\mu A$
	$I_{SHUTDOWN}$	$V_{EN} = 0V$	$T_J = +25^{\circ}C$		0.01	0.1	
			$T_J = +125^{\circ}C$		700		nA
Output Accuracy (MAX38902A/D Only)	ACC38902A/D	$I_{OUT}$ from 0.1mA to 500mA, $V_{IN}$ from $V_{OUT} + 0.3V$ to 5.5V, $V_{IN} > 1.7V$ , $V_{OUT}$ from 0.7V to 5.0V		-1		+1	%
Output Accuracy (MAX38902B/C Only)	ACC38902B/C	$I_{OUT}$ from 0.1mA to 500mA, $V_{IN}$ from $V_{OUT} + 0.3V$ to 5.5V, $V_{IN} > 1.7V$		0.594	0.6	0.606	V
Load Regulation		$I_{OUT}$ from 0.1mA to 500mA, $V_{IN} = V_{OUT} + 300mV$ , $V_{OUT} = 2.5V$			0.07		%
Load Transient		$I_{OUT} = 50mA$ to 500mA to 50mA, $t_{RISE} = t_{FALL} = 1\mu s$			50		mV
Line Regulation		$V_{IN}$ from $V_{OUT} + 0.3V$ to 5.5V, $V_{IN} > 1.7V$ , $I_{OUT} = 200mA$			0.06		%
Line Transient		$V_{IN} = 4V$ to 5V to 4V, $I_{OUT} = 500mA$ , $t_{RISE} = t_{FALL} = 5\mu s$			3		mV
Dropout Voltage ( <a href="#">Note 2</a> )		$I_{OUT} = 500mA$	$V_{IN} = 3.6V$ TDFN	50	100	mV	
			$V_{IN} = 3.6V$ WLP	30	100		
			$V_{IN} = 2.5V$ TDFN	58	200		
			$V_{IN} = 2.5V$ WLP	39	200		
			$V_{IN} = 1.7V$ TDFN	84	300		
			$V_{IN} = 1.7V$ WLP	63	300		
Active Discharge Resistance	$R_{DIS}$	$V_{EN} = 0V$			800		$\Omega$
Current Limit		$V_{OUTS/FB} = 0V$ , $V_{IN} - V_{OUT} = 500mV$		600	700	800	mA
Output Noise		$I_{OUT} = 100mA$ , 10Hz to 100kHz	$C_{BYP} = 47nF$		10.5		$\mu V_{RMS}$
Power Supply Rejection Ratio	PSRR	$I_{OUT} = 100mA$	f = 1kHz		70	dB	
			f = 10kHz		70		
			f = 100kHz		60		
			f = 1MHz		40		
BYP Capacitor Range	$C_{BYP}$	Regulator remains stable		0.001		0.1	$\mu F$
BYP Soft-Start Current		From BYP to GND during startup			50		$\mu A$
EN Input Threshold		$V_{IN}$ from 1.7V to 5.5V	EN rising		0.8	1.2	V
			EN falling	0.4	0.7		

### Electrical Characteristics (continued)

( $V_{IN} = 3.6V$ ,  $V_{OUT} = 3.3V$ ,  $T_J = -40^{\circ}C$  to  $+125^{\circ}C$ ,  $C_{BYP} = 10nF$ ,  $C_{IN} = 4.7\mu F$ ,  $C_{OUT} = 4.7\mu F$ , [Typical Operating Circuits](#). Typical values are at  $T_J = +25^{\circ}C$ , unless otherwise specified. ([Note 1](#)))

PARAMETER	SYMBOL	CONDITIONS		MIN	TYP	MAX	UNITS
EN Input Leakage Current		$V_{EN}$ from 1.7V to 5.5V	$T_J = +25^{\circ}C$	-1	+0.001	+1	$\mu A$
			$T_J = +125^{\circ}C$		0.01		
POK Threshold (MAX38902B Only)		$V_{OUT}$ when POK switches	$V_{OUT}$ rising	88	91	94	%
POK Threshold (MAX38902B Only)		$V_{OUT}$ when POK switches	$V_{OUT}$ falling		88		%
POK Voltage, Low (MAX38902B Only)		$I_{POK} = 1mA$			10	100	mV
POK Leakage Current (MAX38902B Only)		$V_{POK} = 5.5V$	$T_J = +25^{\circ}C$	-0.1	+0.001	+0.1	$\mu A$
			$T_J = +125^{\circ}C$		0.01		
SELA/B Input Resistance (MAX38902A Only)		When shorted to GND or IN.				500	$\Omega$
		When Hi-Z		1			$M\Omega$
SELA/B Input Capacitance (MAX38902A Only)		When Hi-Z				10	pF
Input Reverse-Current Threshold		$V_{OUT} = 3.6V$ , when $V_{IN}$ falls to 0V			200		mA
Thermal Shutdown Threshold		$T_J$ when output turns on/off	$T_J$ rising		165		$^{\circ}C$
			$T_J$ falling		150		

**Note 1:** Limits over the specified operating temperature and supply voltage range are guaranteed by design and characterization, and production tested at  $T_J = +25^{\circ}C$  only.

**Note 2:** Dropout voltage is defined as ( $V_{IN} - V_{OUT}$ ) when  $V_{OUT}$  is 95% of its nominal value.

### Typical Operating Characteristics

(MAX38902A,  $V_{IN} = 3.6V$ ,  $V_{OUT} = 2.5V$ ,  $T_A = +25^\circ C$ ,  $C_{IN} = 4.7\mu F$ ,  $C_{OUT} = 4.7\mu F$ , unless otherwise noted.)

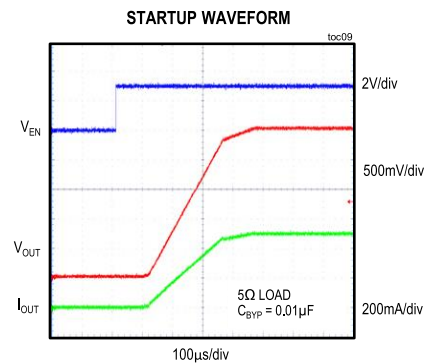
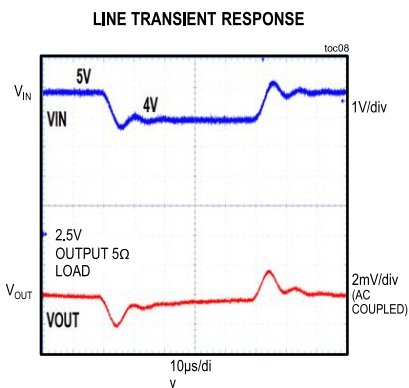
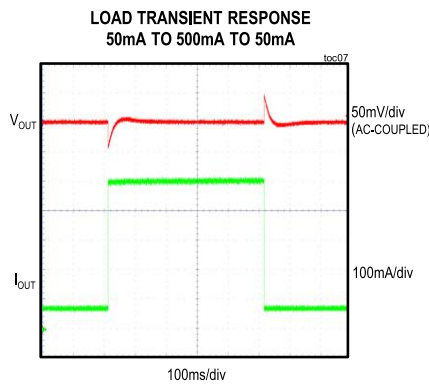
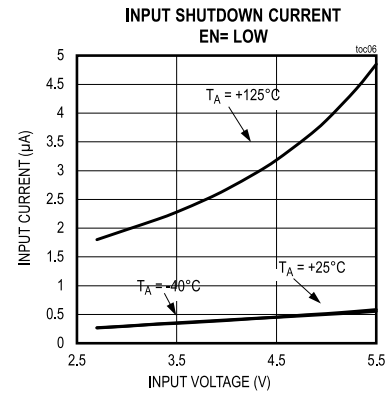
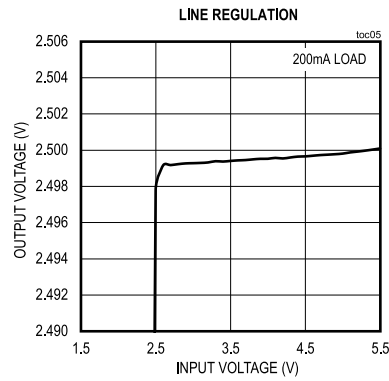
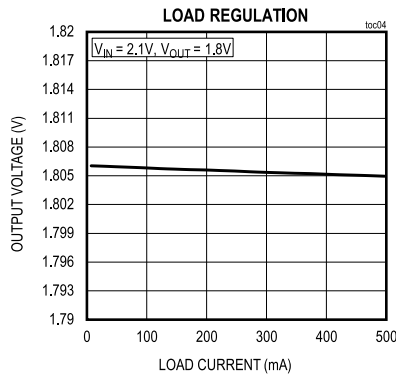
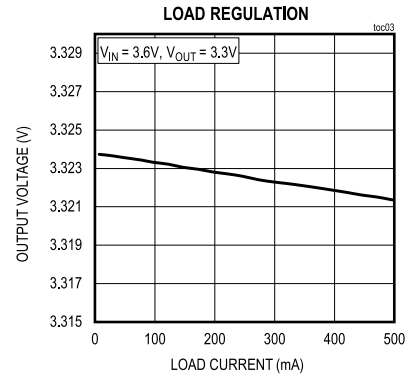
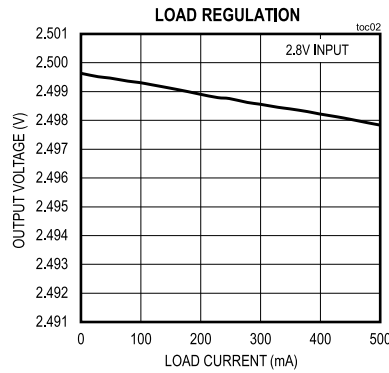
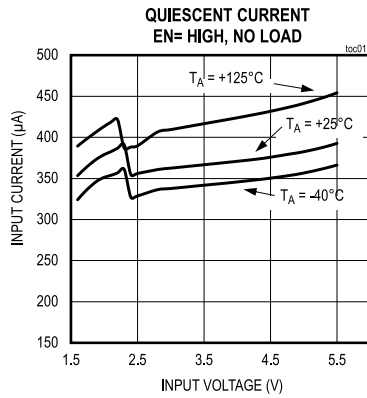

Typical Operating Characteristics (continued)

(MAX38902A, V<sub>IN</sub> = 3.6V, V<sub>OUT</sub> = 2.5V, T<sub>A</sub> = +25°C, C<sub>IN</sub> = 4.7μF, C<sub>OUT</sub> = 4.7μF, unless otherwise noted.)

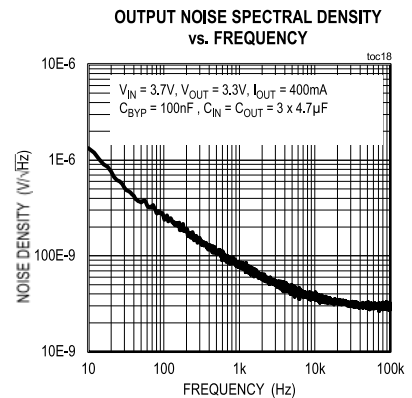
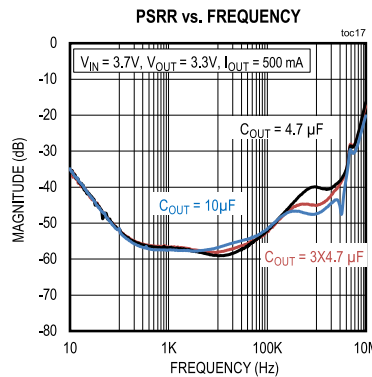
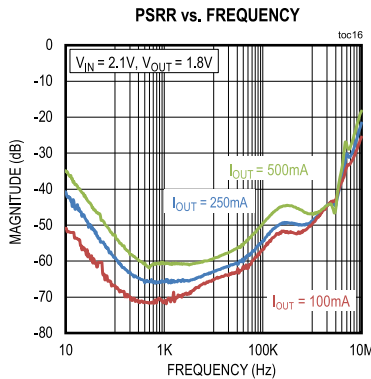
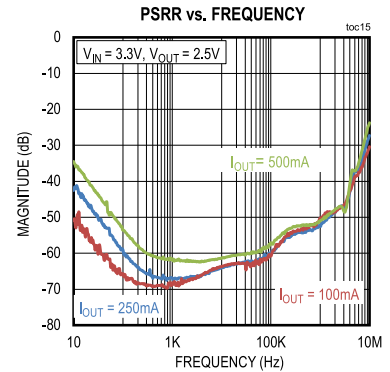
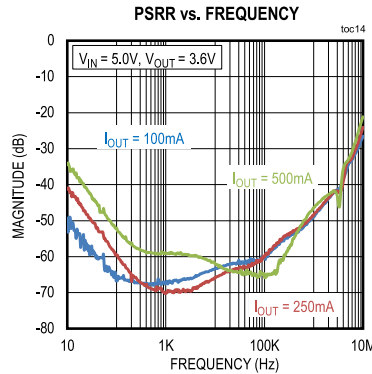
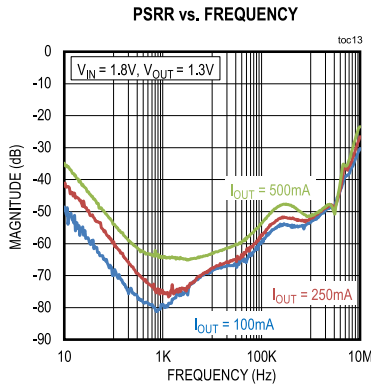
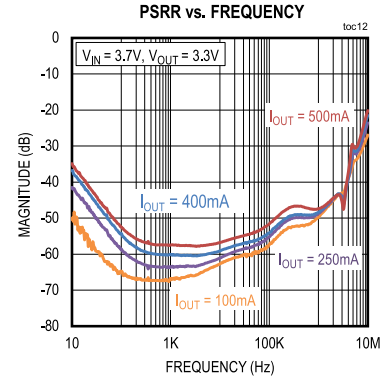
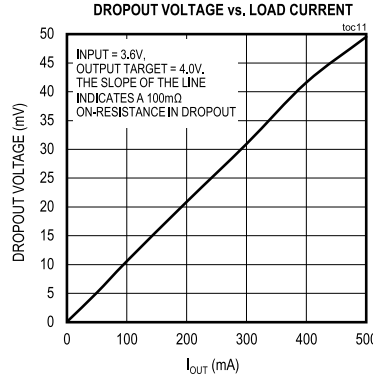
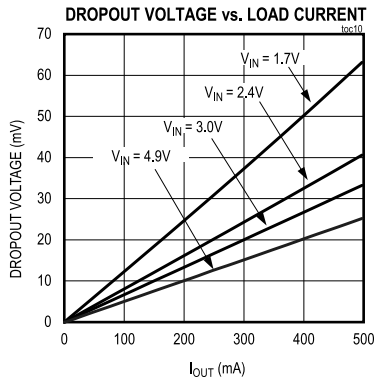

### Typical Operating Characteristics (continued)

(MAX38902A, V<sub>IN</sub> = 3.6V, V<sub>OUT</sub> = 2.5V, T<sub>A</sub> = +25°C, C<sub>IN</sub> = 4.7 $\mu$ F, C<sub>OUT</sub> = 4.7 $\mu$ F, unless otherwise noted.)

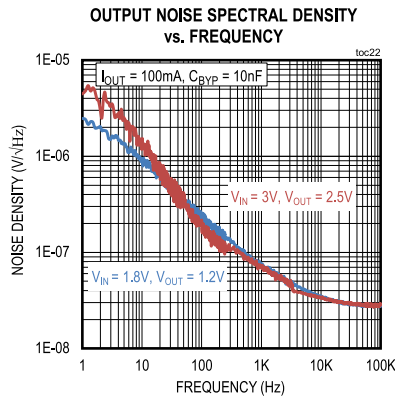
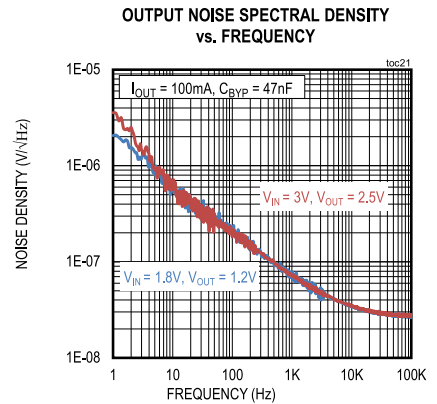
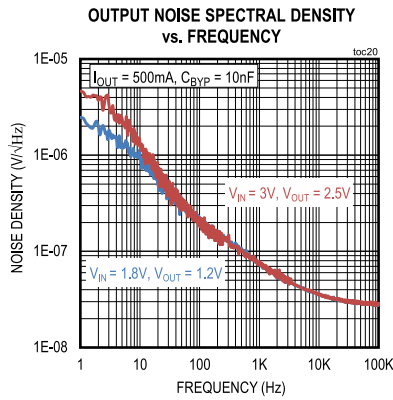
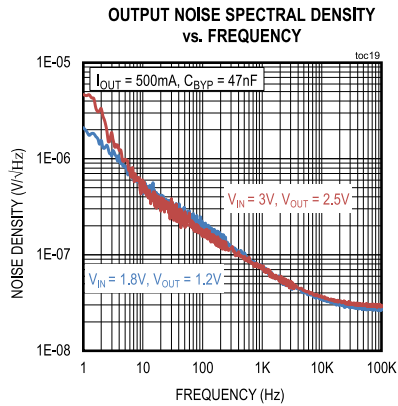



## Pin Configurations

### MAX38902A

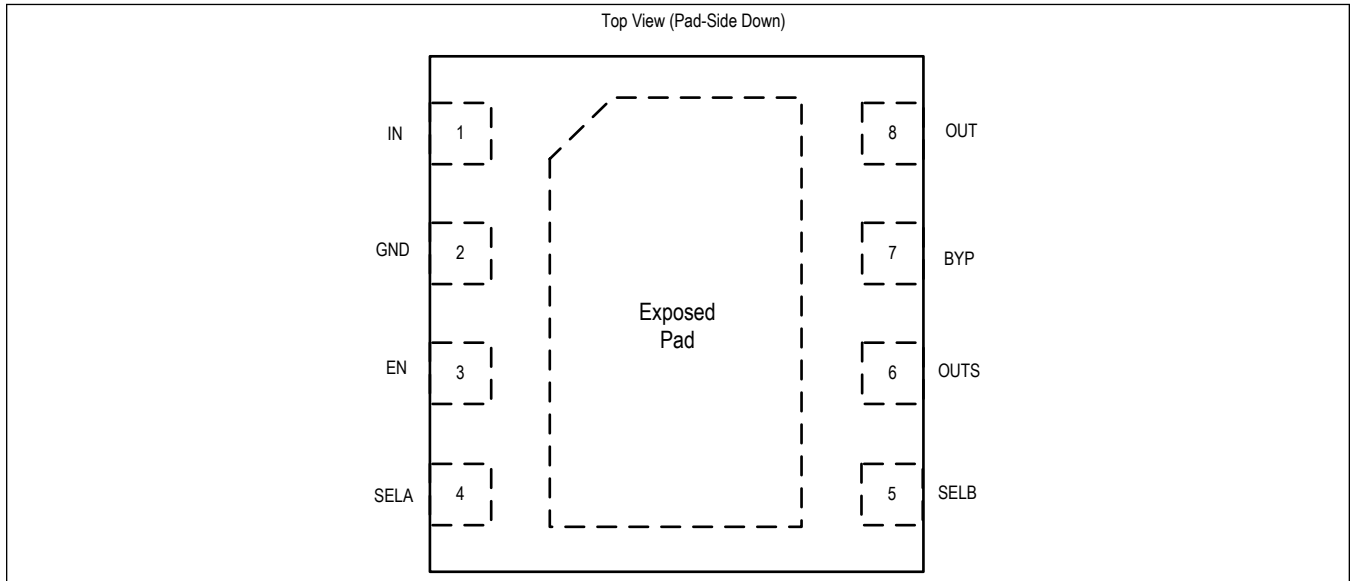

### MAX38902B

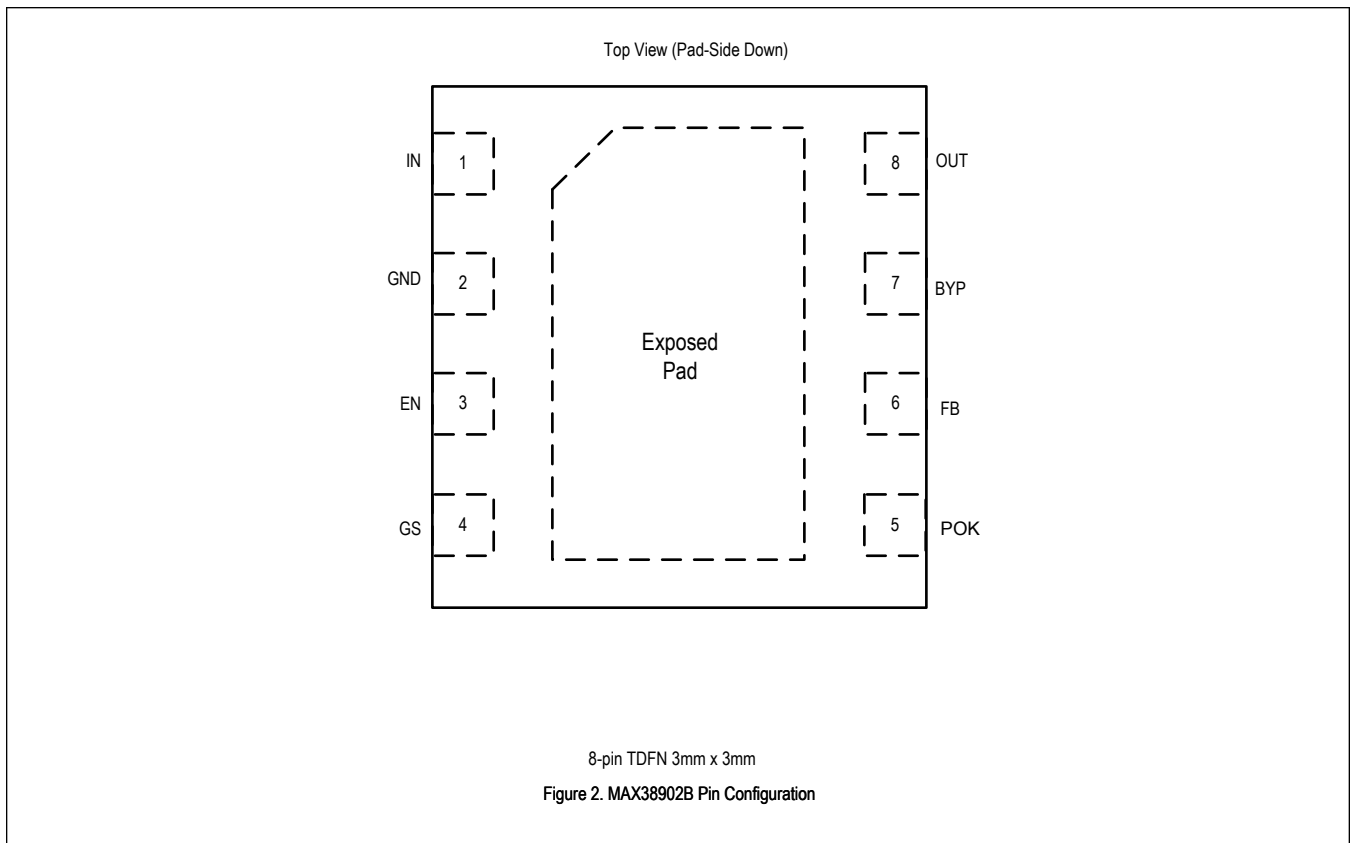

MAX38902A/MAX38902B/  
MAX38902C/MAX38902D

10.5 $\mu$ V<sub>RMS</sub> Low Noise 500mA LDO Linear  
Regulator

**MAX38902C TOP VIEW (BUMP-SIDE DOWN)**

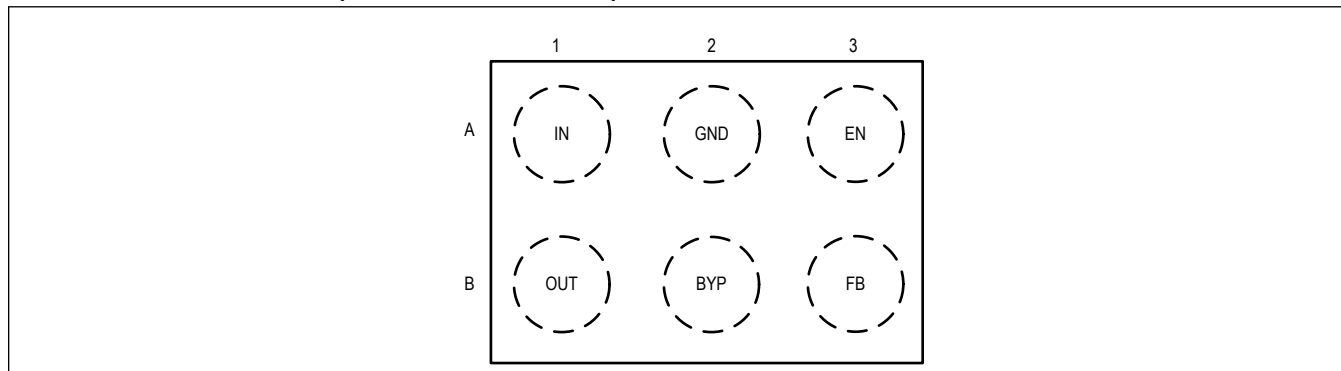

**MAX38902D TOP VIEW (BUMP-SIDE DOWN)**

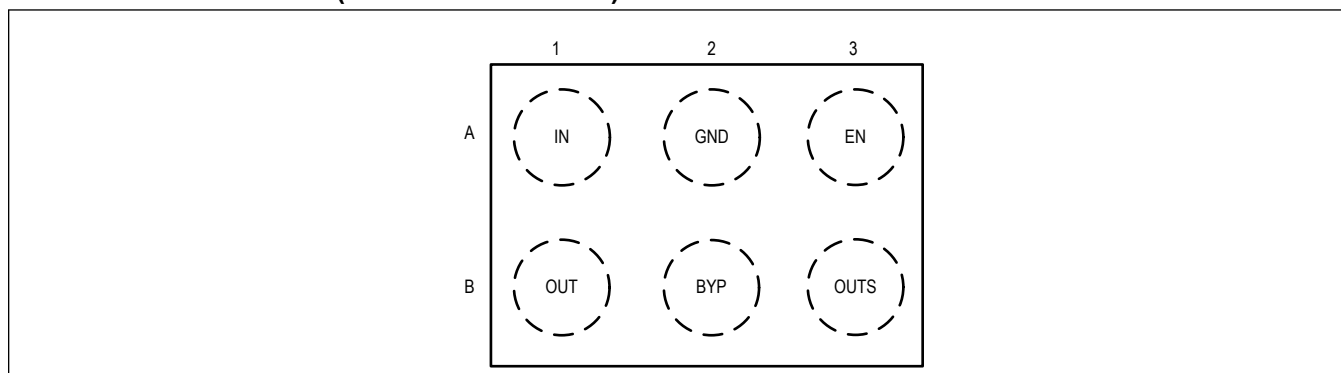

## Pin Description

PIN				NAME	FUNCTION
MAX38902A	MAX38902B	MAX38902C	MAX38902D		
1	1	A1	A1	IN	Regulator Supply Input. Connect to a voltage between 1.7V and 5.5V and bypass with a 4.7 $\mu$ F capacitor from IN to GND.
2	2	A2	A2	GND	Regulator Ground. Bring IN and OUT bypass capacitor GND connections to this pin for best performance.
3	3	A3	A3	EN	Enable Input. Connect this pin to a logic signal to enable ( $V_{EN}$ high) or disable ( $V_{EN}$ low) the regulator output. Connect to IN to keep the output enabled whenever a valid supply voltage is present. When EN is pulled low or disabled, output is shorted to GND through an 800 $\Omega$ active discharge circuit.
4	-	-	-	SELA	Output Select Input. Connect to GND, IN or leave unconnected to select one of three states. The state of the SELA and SELB pins are read when the device is enabled and used to select one of nine output voltages.
-	4	-	-	GS	Ground Sense. Connect GS to GND.
5	-	-	-	SELB	Output Select Input. Connect to GND, IN or leave unconnected to select one of three states. The state of the SELA and SELB pins are read when the device is enabled and used to select one of nine output voltages.
-	5	-	-	$\overline{POK}$	Power-On Reset Output. Connect a pullup resistor from this pin to a supply to create a reset signal that goes low after the regulator output has reached its regulation voltage.
6	-	-	B3	OUTS	Output Voltage Sense Input. Connect to the load at a point where accurate regulation is required to eliminate resistive metal drops.
-	6	B3	-	FB	Feedback Divider Input. Connect a resistor divider string from OUT to GND with the midpoint tied to this pin to set the output voltage. In the <a href="#">Typical Operating Circuits</a> , $V_{OUT} = 0.6V \times (1 + R3/R2)$ .
7	7	B2	B2	BYP	Bypass Capacitor Input. Connect a 0.001 $\mu$ F to 0.1 $\mu$ F capacitor between OUT and BYP to reduce output noise and set the regulator soft-start rate.
8	8	B1	B1	OUT	Regulator Output. Sources up to 500mA at the output regulation voltage. Bypass with a 4.7 $\mu$ F (2 $\mu$ F minimum including voltage derating) low ESR (< 0.03 $\Omega$ ) capacitor to GND.
EP	EP	—	—	EP	Exposed Pad (TDFN Only). Connect the exposed pad to a ground plane with low thermal resistance to ambient to provide best heat sinking.

Simplified Functional Diagram

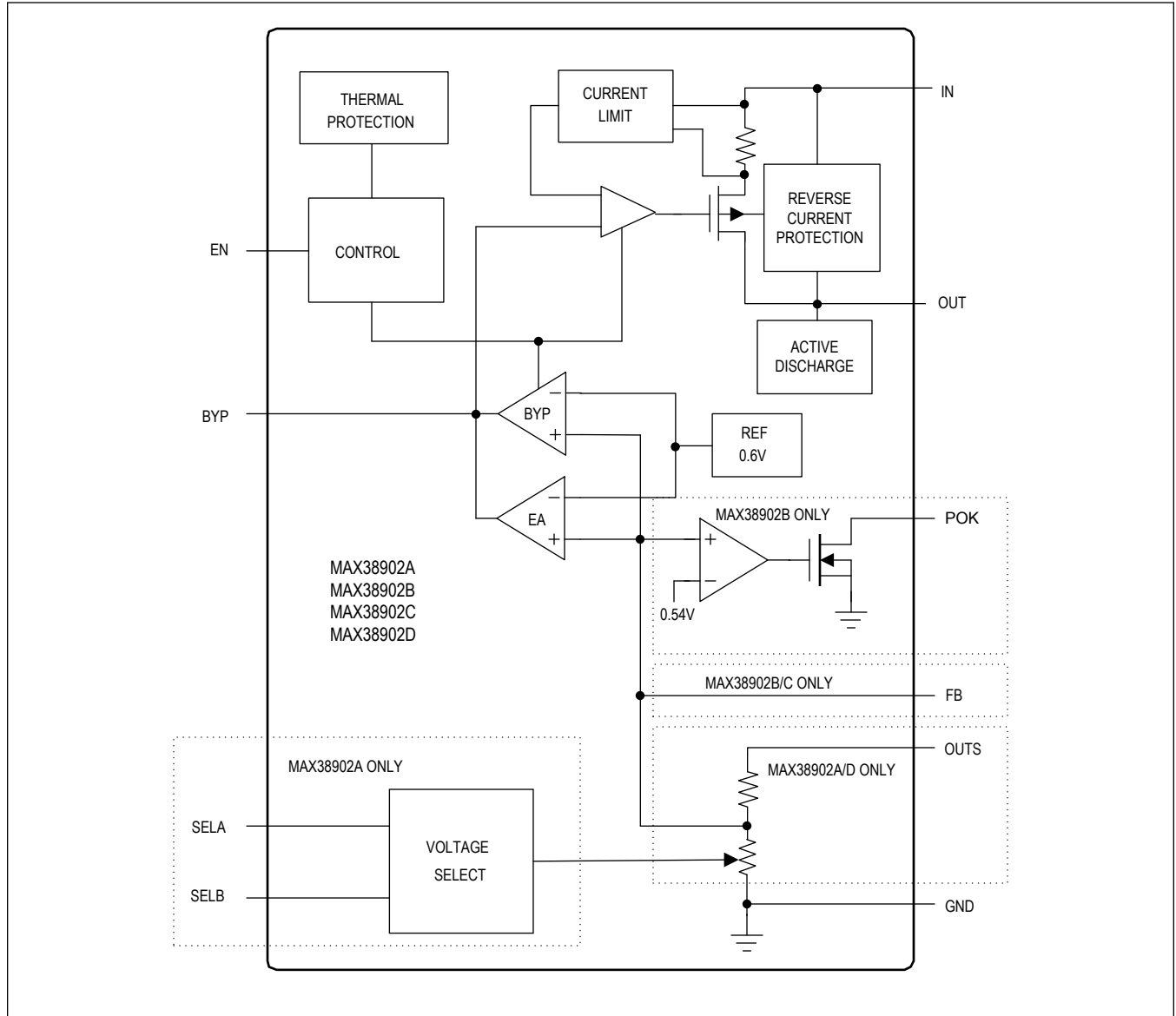

## Detailed Description

The MAX38902A/B/C/D low-noise linear regulators deliver up to 500mA of output current with only 10.5 $\mu$ V<sub>RMS</sub> of output noise in a 10Hz to 100kHz bandwidth. These regulators maintain their output voltage over a wide input range, requiring only 100mV of input-to-output headroom at full load.

The MAX38902 maintains a low 365 $\mu$ A typical supply current, independent of the load current and dropout voltage. The regulator control circuitry includes a programmable soft-start circuit, short-circuit, reverse input current, and thermal-overload protection. Other features include an enable input and power-OK (POK) output (MAX38902B only). See the [Functional Diagram](#).

### Enable (EN)

The MAX38902A/MAX38902B/MAX38902C/MAX38902D include an enable input (EN). Pull EN low to shut down the output, or drive EN high to enable the output. If a separate shutdown signal is not available, connect EN to IN. When EN is pulled low, output voltage is pulled to ground through an 800 $\Omega$  active discharge circuit.

### Bypass (BYP)

The capacitor connected from BYP to OUT filters the noise of the reference, feedback resistors, and regulator input stage, and it provides a high-speed feedback path for improved transient response. A 0.01 $\mu$ F capacitor rolls off input noise at around 32Hz.

The slew rate of the output voltage during startup is also determined by the BYP capacitor. A 0.01 $\mu$ F capacitor sets the slew rate to 5V/ms. This startup rate results in a 50mA slew current drawn from the input at startup to charge the 10 $\mu$ F output capacitance. The BYP capacitor value can be adjusted from 0.001 $\mu$ F to 0.1 $\mu$ F to change the startup slew rate according to the following formula:

$$\text{StartupSlewRate} = (5\text{V} / \text{ms}) \times (0.01\mu\text{F} / C_{\text{BYP}})$$

where  $C_{\text{BYP}}$  is in  $\mu$ F.

Note that this slew rate applies only at startup. That recovery from a short-circuit will occur at a slew rate approximately 500 times slower.

Also note that, being a low-frequency filter node, BYP is sensitive to leakage. BYP leakage currents above 10nA cause measurable inaccuracy at the output and should be avoided.

### Protection Features

The MAX38902A/B/C/D are fully protected from an output short-circuit by a current-limiting and thermal-overload circuit. If the output is shorted to GND, the output current is limited to 700mA (typ). Under these conditions, the part quickly heats up. When the junction temperature reaches +165 $^{\circ}$ C, a thermal limit circuit shuts off the output device. When the junction cools to +150 $^{\circ}$ C, the output turns back on in an attempt to reestablish regulation. While the fault persists, the output current cycles on and off, as the junction temperature slews between +150 $^{\circ}$ C and +165 $^{\circ}$ C.

The MAX38902A/B/C/D are also protected against reverse current when the output voltage is higher than the input. In the event that extra output capacitance is used at the output, a power-down transient at the input would normally cause a large reverse current through a conventional regulator. The MAX38902A/B/C/D include a reverse voltage detector that trips when IN drops 10mV below OUT, shutting off the regulator and opening the pMOS body diode connection, preventing any reverse current.

### Active Discharge

When EN is pulled low, the MAX38902A/MAX38902B/MAX38902C/MAX38902D connects an 800 $\Omega$  resistor from OUT to GND in order to discharge the output capacitors. This feature reduces the time required to discharge the output capacitor, which simplifies system power sequencing.

**Output Voltage Configuration (MAX38902A)**

The MAX38902A output can be set to one of nine voltages by shorting or opening the SELA and SELB inputs, as shown in [Table 1](#). SELA and SELB should be connected to GND, IN, or left unconnected. Alternatively, they may be driven high, low, or open with external logic. However, the states of SELA and SELB are sampled only at startup. The regulation voltage can be set to a different level by cycling EN or IN momentarily to GND.

**Table 1. MAX38902A Output Configuration**

V <sub>OUT</sub> (V)	SELA STATE	SELB STATE
1.2	Unconnected	IN
1.5	IN	Unconnected
1.8	Unconnected	GND
2.5	Unconnected	Unconnected
3.0	GND	GND
3.1	GND	IN
3.3	GND	Unconnected
4.0	IN	GND
5.0	IN	IN

**Output Voltage Configuration (MAX38902B/MAX38902C)**

The MAX38902B/MAX38902C use external feedback resistors to set the output regulation voltage, as shown in the [Typical Operating Circuits](#). The output can be set from 0.6V to 5.3V. Set the lower feedback resistor R2 to 300kΩ or less to minimize FB input bias current error. Then calculate the value of the upper feedback resistor R3 as follows:

$$R3 = R2 \times \left( \frac{V_{OUT}}{V_{FB}} - 1 \right)$$

where V<sub>FB</sub> is the feedback regulation voltage of 0.6V. To set the output voltage to 2.5V, for example, R3 should be:

$$R3 = 300k\Omega \times \left( \frac{2.5V}{0.6V} - 1 \right) = 950k\Omega$$

**Output Voltage Configuration (MAX38902D)**

The MAX38902D output voltage comes preprogrammed; contact a Maxim Integrated representative for preprogrammed voltage selections. Additionally, any voltage between 0.7V and 5.3V in 50mV steps can be factory-trimmed and special-ordered.

**Power-OK (MAX38902B)**

The MAX38902B includes an additional open-drain output,  $\overline{POK}$ , that goes low to indicate the output voltage is in regulation. Connect a pullup resistor from this pin to an external supply. During startup,  $\overline{POK}$  stays high until the output voltage rises to 91% (typ) of its regulation level. If an overload occurs at the output, or the output is shutdown,  $\overline{POK}$  goes high.

**Input Capacitor**

A 4.7µF ceramic capacitor is recommended for the input. Select a capacitor that maintains its capacitance over temperature and DC bias. Capacitors with X5R or X7R temperature characteristics generally perform well.

**Output Capacitor**

A minimum of 2µF capacitance is required at OUT to ensure stability. Select a ceramic capacitor that maintains its capacitance (2µF minimum) over temperature and DC bias. Capacitors with X5R or X7R temperature characteristics generally perform well. For example, the ceramic capacitor part number GRM155R60J475ME47 from Murata (4.7µF/6.3V/X5R) derates to around 2.9µF with 1.8V DC bias.

---

MAX38902A/MAX38902B/  
MAX38902C/MAX38902D

10.5 $\mu$ V<sub>RMS</sub> Low Noise 500mA LDO Linear  
Regulator

### Thermal Considerations

The MAX38902A/B is packaged in an 8-pin, 2mm x 2mm TDFN package with an exposed paddle. The exposed paddle is the main path for heat to leave the IC and, therefore, must be connected to a ground plane with thermal vias to allow heat to dissipate from the device. Thermal properties of the IC package are given in the [Package Information](#) section.

MAX38902A/MAX38902B/  
MAX38902C/MAX38902D

10.5 $\mu$ V<sub>RMS</sub> Low Noise 500mA LDO Linear  
Regulator

## Ordering Information

PART NUMBER	TEMPERATURE RANGE	PIN-PACKAGE	FEATURES
MAX38902AATA+	-40°C to +125°C	8 TDFN	Pin-Selectable Output Voltage
MAX38902BATA+	-40°C to +125°C	8 TDFN	External Resistor Feedback with $\overline{POK}$ output
MAX38902CANT+	-40°C to +125°C	6 WLP	External Resistor Feedback
MAX38902DANT__+	-40°C to +125°C	6 WLP	Factory-Trimmed Option from 0.7V to 5.0V
MAX38902DANT12+	-40°C to +125°C	6 WLP	Factory-Programmed to 1.2V
MAX38902DANT18+	-40°C to +125°C	6 WLP	Factory-Programmed to 1.8V
MAX38902DANT27+	-40°C to +125°C	6 WLP	Factory-Programmed to 2.7V
MAX38902DANT33+	-40°C to +125°C	6 WLP	Factory-Programmed to 3.3V
MAX38902DANT46+	-40°C to +125°C	6 WLP	Factory-Programmed to 4.6V

+Denotes a lead(Pb)-free/RoHS-compliant package.



## Revision History

REVISION NUMBER	REVISION DATE	DESCRIPTION	PAGES CHANGED
0	11/17	Initial release	—
1	1/18	Updated future product status of MAX38902BATA+	11
2	4/18	Updated <i>Ordering Information</i> table	11
3	8/18	Updated <i>Electrical Characteristics, Benefits and Features</i> , and <i>Ordering Information</i> sections	1, 4, 11
4	10/18	Updated <i>Electrical Characteristics, Benefits and Features</i> , Typical Operating Characteristics, and <i>Ordering Information</i> sections	1, 4, 11
5	12/18	Updated Absolute Maximum Ratings, Table 2, and <i>Ordering Information</i>	2, 11
6	9/19	Updated <i>Ordering Information</i> for MAX38902DANT12+ and MAX38902DANT18+	11
7	3/20	Updated Typical Operating Characteristics, EC table Vout value is mentioned	4, 5, 6
8	3/21	Removed Table 2, updated <i>Ordering Information</i> for MAX38902DANT33+	14, 15
9	6/21	Updated Absolute Maximum Ratings table	3
10	7/22	Updated Functional Block Diagram, <i>General Description, Benefits and Features, Electrical Characteristics</i> , and <i>Pin Description</i> ; Added <i>Active Discharge</i> Section	1, 4, 11, 12, 13