

Microwave Wideband Synthesizer with Integrated VCO

FEATURES

- ▶ Fundamental VCO frequency range: 10 GHz to 20 GHz
- ▶ VCO phase noise improvement of up to 3 dB as compared to [ADF4382](#)
- ▶ Integrated RMS jitter at 20 GHz = 18 fs (integration bandwidth: 100 Hz to 100 MHz)
- ▶ Integrated RMS jitter at 20 GHz = 31 fs (ADC SNR method)
- ▶ VCO fast calibration time: <2 μ s
- ▶ VCO autocalibration time: <100 μ s
- ▶ Phase noise floor: -156 dBc/Hz at 20 GHz
- ▶ PLL specifications
 - ▶ -239 dBc/Hz: normalized in-band phase noise floor (integer mode)
 - ▶ -287 dBc/Hz: normalized 1/f phase noise floor
 - ▶ 625 MHz maximum phase/frequency detector input frequency
 - ▶ 4.5 GHz reference input frequency
 - ▶ Typical spurious f_{PFD} : -90 dBc
- ▶ Reference to output delay specifications
 - ▶ Propagation delay temperature coefficient: 0.06 ps/ $^{\circ}$ C
 - ▶ Adjustment step size: <1 ps
- ▶ Multichip output phase alignment
- ▶ 3.3 V and 5 V power supplies
- ▶ ADIsimPLL™ loop filter design tool support
- ▶ 7 mm \times 7 mm, 48-terminal LGA
- ▶ -40 $^{\circ}$ C to +105 $^{\circ}$ C operating temperature

APPLICATIONS

- ▶ High performance data converter clocking
- ▶ Wireless infrastructure (MC-GSM, 5G, 6G)
- ▶ Test and measurement

GENERAL DESCRIPTION

The ADF4383 is a high performance, ultra-low jitter, fractional-N phased-locked loop (PLL) with an integrated voltage controlled oscillator (VCO) ideally suited for local oscillator (LO) generation for 5G applications or data converter clock applications. The high performance PLL has a figure of merit of -239 dBc/Hz, low 1/f noise and high PFD frequency of 625 MHz in integer mode that can achieve ultra-low in-band noise and integrated jitter. The ADF4383 can generate frequencies in a fundamental octave range of 10 GHz to 20 GHz, thereby eliminating the need for subharmonic filters. The output dividers on the ADF4383 allows a complete output frequency range to be generated from 625 MHz to 20 GHz.

For multiple data converter clock applications, the ADF4383 automatically aligns its output to the input reference edge by including the output divider in the PLL feedback loop. For applications that require deterministic delay or delay adjustment capability, a programmable reference to output delay with <1 ps resolution is provided. The reference to output delay matching across multiple devices and over temperature allows predictable and precise multichip alignment.

The simplicity of the ADF4383 block diagram eases development time with a simplified serial peripheral interface (SPI) register map, external SYNC input, and repeatable multichip alignment in both integer and fractional mode.

FUNCTIONAL BLOCK DIAGRAM

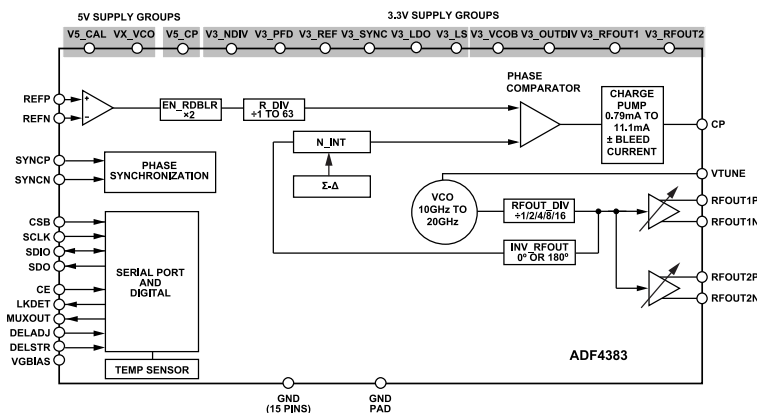

Figure 1. ADF4383 Functional Block Diagram

TABLE OF CONTENTS

Features.....	1	Circuit Description.....	20
Applications.....	1	Applications Information.....	31
General Description.....	1	Power-Up and Initialization Sequence.....	31
Functional Block Diagram.....	1	Loop Filter Design.....	33
Specifications.....	3	Reference Source Considerations.....	33
Serial Interface Timing Characteristics.....	7	SYNC Input Network.....	34
Phase Adjust 2-Wire Interface.....	8	Output Phase Noise Characteristics.....	34
Absolute Maximum Ratings.....	9	Output Phase Synchronization of Multiple ADF4383 Devices.....	35
Thermal Resistance.....	9	Phase Synchronization Settings.....	37
Transistor Count.....	9	Phase Resynchronization.....	38
Electrostatic Discharge (ESD) Ratings.....	9	Register Map.....	39
ESD Caution.....	9	Register Details.....	44
Pin Configuration and Function Descriptions.....	10	Outline Dimensions.....	80
Typical Performance Characteristics.....	12	Ordering Guide.....	80
Theory of Operation.....	19	Evaluation Boards.....	80
Introduction.....	19		
Output Frequency.....	20		

REVISION HISTORY**1/2025—Revision 0: Initial Version**

SPECIFICATIONS

3.3 V Supply Group 1 pins voltage ($V_{3.3V_1}$) = 3.3 V Supply Group 2 pins voltage ($V_{3.3V_2}$) = 3.15 V to 3.45 V, V_{5V_VCO} voltage (V_{5V_VCO}) = 5V_CP voltage (V_{5V_CP}) = 5V_CAL voltage (V_{5V_CAL}) = 4.75 V to 5.25 V, all voltages are with respect to GND, and $T_A = -40^\circ\text{C}$ to $+105^\circ\text{C}$, operating temperature range, unless otherwise noted.

Parameter	Symbol	Min	Typ	Max	Unit	Test Conditions/Comments
REFERENCE INPUTS (REFP AND REFN)						
Input Frequency	f_{REF}	10		4500	MHz	Refer to Figure 46
Input Signal Level	V_{REF}	0.5		2.6	V p-p	
Minimum Input Slew Rate			100		V/ μs	
Input Duty Cycle			50		%	
Self Bias Voltage			1.85		V	
Input Resistance			3		k Ω	
Input Capacitance			1		pF	
Input Current			2		μA	
REFERENCE PEAK DETECTOR						
Input Frequency		10		4500	MHz	$f_{REF} = 100$ MHz, single-ended sine wave
Minimum Input Signal Detected (REF_OK = 1)			200		mV p-p	
Maximum Input Signal Not Detected (REF_OK = 0)			160		mV p-p	
REFERENCE DIVIDER						
		1		63		All integers included
REFERENCE DOUBLER						
Input Frequency		10		2000	MHz	EN_RDBLR = 1
PHASE/FREQUENCY DETECTOR (PFD)						
Input Frequency	f_{PFD}					Integer mode, for all values of the N divider, excluding 15 and 28 to 31 For the N divider values 15 and 28 to 31 EFM3_MODE = 0 and EFM3_MODE = 4 EFM3_MODE = 5
Integer Mode		5.4		625	MHz	
		5.4		540	MHz	
Fractional Mode		5.4		250	MHz	
		5.4		220	MHz	
SYNCHRONIZATION INPUTS (SYNCP AND SYNCN)						
Input Signal Level	V_{REF}	0.4		2.6	V p-p	Low voltage differential signaling (LVDS) mode, differential
		0.5		2.6	V p-p	
Self Bias Voltage			1.3		V	Current mode logic (CML) mode, differential LVDS mode
			1.85		V	
Synchronization to Reference Setup Time		400			ps	Common-mode voltage (V_{CM}) set to self bias voltage, $V_{CM} = 0.8$ V p-p
Synchronization to Reference Hold Time		600			ps	V_{CM} set to self bias voltage, $V_{CM} = 0.8$ V p-p
Input Resistance			3		k Ω	Differential
Input Capacitance			1		pF	Differential
Input Current			3		μA	
CHARGE PUMP (CP)						
Output Current	I_{CP}					Set by the CP_I bit fields
Minimum			0.79		mA	
Maximum			11.1		mA	Set by the CP_I bit fields
Output Current Source and Sink						All setting, CP voltage (V_{CP}) = $V_{CP}/2$
Accuracy			± 2		%	
Matching			± 2		%	All setting, $V_{CP} = V_{CP}/2$
Output Current vs. Output Voltage Sensitivity			0.2		% V/V	V_{CP}^1
Output Current vs. Temperature			280		ppm/C	$V_{CP} = V_{CP}/2$
Output High-Z Leakage Current			-0.01		μA	Minimum I_{CP} , V_{CP}^1
			-0.3		μA	Maximum I_{CP} , V_{CP}^1

SPECIFICATIONS

Parameter	Symbol	Min	Typ	Max	Unit	Test Conditions/Comments	
VCO							
Fundamental Frequency Range	f_{VCO}	10		20	GHz		
VCO Autocalibration Time			100		μ s		
Tuning Sensitivity	K_{VCO}		50 to 150		MHz/V	$K_{VCO}^{2,3}$	
Lock and Leave Temperature Range ⁴		-40		+105	$^{\circ}$ C	Maintains lock without reprogramming the device	
Divided Reference Clock (DIV_RCLK) VCO Calibration Frequency	f_{DIV_RCLK}			125	MHz	Must set DCLK_MODE = 1, when $f_{DIV_RCLK} > 80$ MHz	
FEEDBACK (N) AND OUTPUT DIVIDER (O)							
N		4		4095		Integer mode	
		19		4095		Fractional mode	
O		1		16		1, 2, 4, 8, and 16	
RF OUTPUTS (RFOUT1P and RFOUT1N, RFOUT2P and RFOUT2N)							
Output Frequency	f_{OUT}	10		20	GHz	Differential termination = 100 Ω for all RF output (RFOUT) specifications unless otherwise noted	
Divide by 2		5		10	GHz		
Divide by 4		2.5		5	GHz		
Divide by 8		1.25		2.5	GHz		
Divide by 16		0.625		1.25	GHz		
Differential RF Output Power	P_{RFOUT}		10		dBm		RFOUT1_OPWR = RFOUT2_OPWR = 11, $f_{OUT} = 11$ GHz
			9		dBm		RFOUT1_OPWR = RFOUT2_OPWR = 11, $f_{OUT} = 14$ GHz
			5		dBm		RFOUT1_OPWR = RFOUT2_OPWR = 11, $f_{OUT} = 20$ GHz
Output Resistance			100		Ω		Differential
Output Common Mode			$3.3 - V_{OD}^5$		V		
Output Rise Time	t_R		15		ps		20% to 80%, RFOUT1_OPWR = RFOUT2_OPWR = 1
Output Fall Time	t_F		15		ps		80% to 20%, RFOUT1_OPWR = RFOUT2_OPWR = 1
Output Duty Cycle			50		%		
Skew, RFOUT1 to RFOUT2			± 3		ps		
REFERENCE INPUT TO OUTPUT DELAY							
Propagation Delay	t_{PD}		190		ps	Device setup for all delay specifications unless noted as follows, measure rising reference edge at reference input to rising edge at RFOUT output REF_SEL = 0 and REF_SEL = 1 REF_SEL = 0	
Propagation Delay Temperature Coefficient	t_{PD-TC}		0.06		ps/ $^{\circ}$ C		
LOGIC INPUTS (CSB, SCLK, SDIO, DELADJ and DELSTR)							
Input High Voltage	V_{INH}	1.2			V		
Input Low Voltage	V_{INL}			0.6	V		
Input Current	I_{IH}/I_{IL}			± 1	μ A		
Input Capacitance	C_{IN}		3		pF		
LOGIC INPUT (CE)							
Input High Voltage	V_{INH-3V}	1.8			V		
Input Low Voltage	V_{INL-3V}			0.8	V		
Input Current	I_{IH-3V}/I_{IL-3V}			± 1	μ A		
Input Capacitance	C_{IN-3V}		3		pF		

SPECIFICATIONS

Parameter	Symbol	Min	Typ	Max	Unit	Test Conditions/Comments
LOGIC OUTPUTS (SDIO, SDO, LKDET, and MUXOUT)						
Output High Voltage (1.8 V Mode)	$V_{OH-1.8V}$	1.5	1.8	2	V	Output high current (I_{OH}) = 500 μ A, 1.8 V output selected (default setting)
Output High Voltage (3.3 V Mode)	V_{OH-3V}	$V_{3.3V} - 0.4$				I_{OH} = 500 μ A, 3.3 V output selected, set by the voltage on the V3_LDO pin, and CMOS_OV can set to either 1.8 V or 3.3 V logic
Output Low Voltage	V_{OL}			0.4	V	Output low current (I_{OL}) = 500 μ A
SDO High-Z Leakage	I_{ZH}/I_{ZL}			± 1	μ A	
POWER SUPPLIES						
V5_VCO Supply Range	V_{V5_VCO}	4.75	5	5.25	V	Device Setup is default configuration for all Supply Current specifications unless noted below.
V5_CAL Supply Range	V_{V5_CAL}	4.75	5	5.25	V	
V5_CP Supply Range	V_{V5_CP}	4.75	5	5.25	V	
V3.3V_1 Supply Range	$V_{3.3V_1}$	3.15	3.3	3.45	V	Group 1: V3_LS, V3_LDO, V3_REF, V3_PFD, V3_NDIV, and V3_SYNC
V3.3V_2 Supply Range	$V_{3.3V_2}$	3.15	3.3	3.45	V	Group 2: V3_RFOUT1, V3_RFOUT2, V3_VCO, and V3_OUTDIV
V5_VCO Supply Current	I_{5V_VCO}		140	195	mA	f_{OUT} = 10 GHz to 20 GHz, RFOUT_DIV = 0, maximum charge pump current
V5_CAL Supply Current	I_{5V_CAL}		105	215	μ A	During VCO calibration
V5_CP Supply Current	I_{5V_CP}		60	70	mA	
V3.3V_1 Supply Current	$I_{3.3V_1}$		200	240	mA	PD_RFOUT1 = 0, PD_RFOUT2 = 0, RFOUT1_OPWR = 11, and RFOUT2_OPWR = 11 (maximum power)
V3.3V_2 Supply Current	$I_{3.3V_2}$		310	340	mA	
Typical Power Dissipation	P_{DIS}		2.2 to 2.6			
Typical Power Down Current						
3.3 V			3.1		mA	PD_ALL = 1, $I_{3.3V_1}$ + $I_{3.3V_2}$
5 V			340		μ A	PD_ALL = 1, I_{VCO-5V} + I_{CAL-5V} + I_{CP-5V}
Typical Disable Current						
3.3 V Supplies			710		μ A	CE = low, $I_{3.3V_1}$ + $I_{3.3V_2}$
5 V Supplies			340		μ A	CE = low, I_{VCO-5V} + I_{CAL-5V} + I_{CP-5V}
RF OUTPUT NOISE CHARACTERISTICS						
RF Output = 20 GHz						
Phase Noise Floor			-156		dBc/Hz	VCO noise in open-loop conditions, and offset from 20 GHz carrier
100 KHz Offset			-106		dBc/Hz	
1 MHz Offset			-128		dBc/Hz	
10 MHz Offset			-147		dBc/Hz	
RF Output = 14 GHz						
Phase Noise Floor			-156		dBc/Hz	VCO noise in open-loop conditions and offset from 14 GHz carrier
100 KHz Offset			-108		dBc/Hz	
1 MHz Offset			-128		dBc/Hz	
10 MHz Offset			-148		dBc/Hz	

SPECIFICATIONS

Parameter	Symbol	Min	Typ	Max	Unit	Test Conditions/Comments
Normalized In-Band Phase Noise Floor ⁶						
Integer Mode	$L_{\text{NORM-INT}}$		-239		dBc/Hz	
Fractional Mode	$L_{\text{NORM-FRAC}}$		-237		dBc/Hz	
Normalized 1/f Phase Noise Floor ^{6,7}	$L_{1/f}$		-287		dBc/Hz	Normalized to 1 Hz
Normalized 1/f Figure of Merit (FOM) ⁷	L_{1/f_1G_10k}					
Integer Mode	$L_{1/f_1G_10k \text{ INT}}$		-147		dBc/Hz	
Fractional Mode	$L_{1/f_1G_10k \text{ FRAC}}$		-143		dBc/Hz	
Integrated RMS Jitter						
Integration Bandwidth: 100 Hz to 100 MHz			18		fs	RFOUT = 20 GHz
ADC SNR Method			31		fs	RFOUT = 20 GHz
Spurious						
f_{REF}			<-95		dBc	
f_{PFD}			-90		dBc	
TEMPERATURE SENSOR (ANALOG-TO-DIGITAL CONVERTER (ADC))						
ADC Clock Frequency	$f_{\text{ADC_CLK}}$			400	kHz	ADC clock divider output
ADC Clock Divider Frequency	$f_{\text{ADC_CLKDIV}}$			125	MHz	ADC clock divider input
Resolution				8	Bits	

¹ $0.9 \text{ V} < V_{\text{CP}} < V_{5V_CP} - 0.9 \text{ V}$.

² Valid for $1.60 \text{ V} \leq V_{\text{TUNE}} \leq 2.85 \text{ V}$ with part calibrated after a power cycle or software power-on reset.

³ Based on characterization.

⁴ Temperature range is covered by autocalibration only. Manual calibration also provides full range provided an autocalibration has been performed to obtain VCO values.

⁵ V_{OD} is the output differential voltage.

⁶ These values are modeled in ADIsimPLL.

⁷ Integrated ranged 1 kHz to f_{OUT} .

SPECIFICATIONS

SERIAL INTERFACE TIMING CHARACTERISTICS

$V_{3.3V_1} = 3.3\text{ V}$, $V_{3.3V_2} = 3.15\text{ V to }3.45\text{ V}$, $V_{5V_VCO} = V_{5V_CP} = V_{5V_CAL} = 4.75\text{ V to }5.25\text{ V}$, all voltages are with respect to GND, and $T_A = T_{MIN}$ to T_{MAX} , unless otherwise noted.

Table 1. Serial Interface Timing Characteristics

Parameter	Symbol	Min	Typ	Max	Unit	Test Conditions/Comments
SERIAL INTERFACE (CSB, SCLK, SDIO, SDO)						See Figure 2, Figure 3, and Figure 4
SCLK Frequency	f_{SCLK}			75	MHz	
SCLK Pulse Width High	t_{HIGH}	6			ns	
SCLK Pulse Width Low	t_{LOW}	6			ns	
SDIO Setup Time	t_{DS}	4			ns	
SDIO Hold Time	t_{DH}	2			ns	
SCLK Fall Edge to SDIO Valid Prop Delay	t_{ACCESS_SDIO}	6			ns	
SCLK Fall Edge to SDO Valid Prop Delay	t_{ACCESS_SDO}	6			ns	
CSB Rising Edge to SDIO High-Z	t_Z	6			ns	
CSB Falling Edge to SCLK Rise Setup Time	t_S	2			ns	
SCLK Rising Edge to CSB Rise Hold Time	t_H	3			ns	

Serial Interface Timing Diagrams

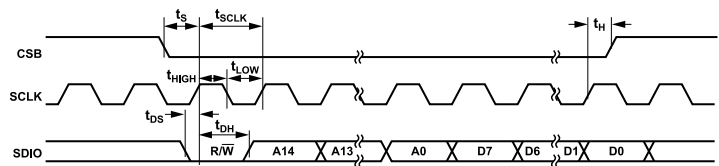

Figure 2. Write Timing Diagram

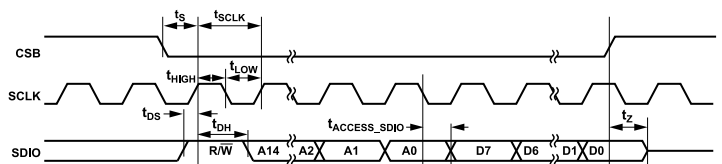

Figure 3. 3-Wire Read Timing Diagram (SDO_ACTIVE = 0)

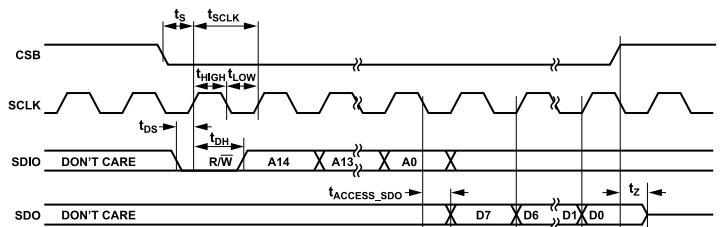

Figure 4. 4-Wire Read Timing Diagram (SDO_ACTIVE = 1)

SPECIFICATIONS

PHASE ADJUST 2-WIRE INTERFACE

Table 2. Phase Adjust 2-Wire Interface Specifications

Parameter	Symbol	Min	Typ	Max	Unit
TIME					
Setup	t_{SU}	20			ns
Hold	t_{HLD}	20			ns
STROBE WIDTH	t_{STR}	10			ns

Phase Adjust 2-Wire Interface Timing Diagram

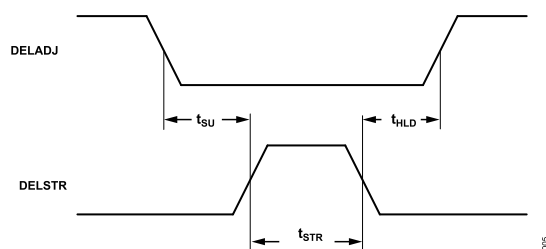

Figure 5. 2-Wire Phase Adjust Timing Diagram

ABSOLUTE MAXIMUM RATINGS

$T_A = 25^\circ\text{C}$, unless otherwise noted.

Table 3. Absolute Maximum Ratings

Parameter	Rating
$V_{3.3V_1}$ ($V3_LS$, $V3_LDO$, $V3_REF$, $V3_PFD$, and $V3_NDIV$) to GND	-0.3 V to +3.6 V
$V_{3.3V_2}$ ($V3_VCO$, $V3_OUTDIV$, $V3_RFOUT1$, and $V3_FOUT2$) to GND	-0.3 V to +3.6 V
V_{V5_CAL} , V_{V5_VCO} , and V_{V5_CP} to GND	-0.3 V to +5.5 V
Voltage on CP Pin	-0.3 V to $V_{V5_CP} + 0.3$ V
Voltage on All Other Pins	-0.3 V to $V_{3.3V_1} + 0.3$ V
Digital Outputs (MUXOUT, LKDET, SDO, and SDIO)	5 mA
RFOUT1P/RFOUT1N and RFOUT2P/RFOUT2N	Maximum (GND - 0.3 V, $V_{3.3V_2} - 1.2$ V) to $V_{3.3V_2} + 0.3$ V
REFP and REFN	-0.65 V to $V_{3.3V_1} + 0.65$ V
Voltage on all Other Pins	-0.3 V to $V_{3.3V_1} + 0.3$ V
REFP to REFN and SYNCN to SYNCN	± 1.35 V
Temperature	
Operating Junction Range	-40°C to +125°C
Storage Range	-55°C to +150°C
Maximum Junction	150°C
Reflow Soldering	
Peak Temperature	260°C
Time at Peak Temperature	30 sec

Stresses at or above those listed under Absolute Maximum Ratings may cause permanent damage to the product. This is a stress rating only; functional operation of the product at these or any other conditions above those indicated in the operational section of this specification is not implied. Operation beyond the maximum operating conditions for extended periods may affect product reliability.

THERMAL RESISTANCE

Thermal performance is directly linked to printed circuit board (PCB) design and operating environment. Careful attention to PCB thermal design is required.

θ_{JA} is specified for the worst-case conditions, that is, a device soldered in a circuit board for surface-mount packages. θ_{JC-TOP} and $\theta_{JC-BOTTOM}$ are the junction-to-case thermal resistance top and bottom.

Table 4. Thermal Resistance

Package Type ¹	θ_{JA}	θ_{JC-TOP}	$\theta_{JC-BOTTOM}$	Unit
CC-48-10	25.23	16.11	5.10	°C/W

¹ Test Condition 1: thermal impedance simulated values are based on use of a 4-layer PCB with the thermal impedance paddle soldered to a ground plane.

TRANSISTOR COUNT

The transistor count for the ADF4383 is 4700 (bipolar) and 385,400 (CMOS).

ELECTROSTATIC DISCHARGE (ESD) RATINGS

The following ESD information is provided for handling of ESD-sensitive devices in an ESD protected area only.

Human body model (HBM) per ANSI/ESDA/JEDDEC JS-001.

Charged device model (CDM) per ANSI/ESDA/JEDEC JS-002.

ESD Ratings for ADF4383

Table 5. ADF4383, 48-Terminal LGA

ESD Model	Withstand Threshold (V)	Class
HBM	4000	3A
CDM	1000	C3

ESD CAUTION



ESD (electrostatic discharge) sensitive device. Charged devices and circuit boards can discharge without detection. Although this product features patented or proprietary protection circuitry, damage may occur on devices subjected to high energy ESD. Therefore, proper ESD precautions should be taken to avoid performance degradation or loss of functionality.

PIN CONFIGURATION AND FUNCTION DESCRIPTIONS

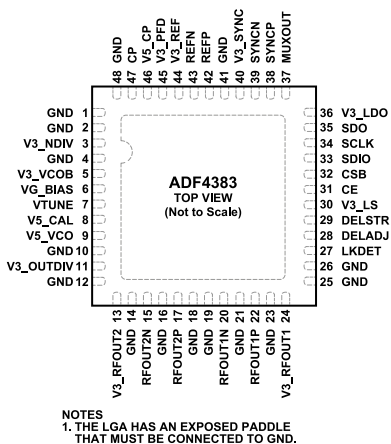

Figure 6. Pin Configuration

Table 6. Pin Function Descriptions

Pin No.	Mnemonic	Description
1, 2, 4, 10, 12, 14, 16, 18, 19, 21, 23, 25, 26, 41, 48	GND	Negative Power Supply (Ground). Tie the GND pins directly to the ground pad.
3	V3_NDIV	3.15 V to 3.45 V Positive Power Supply Pin for the PLL Feedback Divider Circuitry. Short the V3_NDIV pin to the other pins in the 3.3 V Power Supply Group 1.
5	V3_VCOB	3.15 V to 3.45 V Positive Power Supply Pin for the Bias Circuitry and Digital Logic Control Portion of the VCO. Short the V3_VCOB pin to the other pins in the 3.3 V Power Supply Group 2.
6	VG_BIAS	Bias Decoupling Pin. Connect uninstalled 0402, 0.1 μ F capacitor footprint to GND.
7	VTUNE	VCO Tuning Input. This frequency control pin is normally connected to the external loop filter.
8	V5_CAL	4.75 V to 5.25 V Positive Power Supply Pin for VCO Calibration Circuitry. The V5_CAL pin can be shorted to the V5_VCO supply plane.
9	V5_VCO	4.75 V to 5.25 V Positive Power Supply Pin for the VCO Circuitry.
11	V3_OUTDIV	3.15 V to 3.45 V Positive Power Supply Pin for the Output Divider Circuitry. Short the V3_OUTDIV pin to the other pins in the 3.3 V Power Supply Group 2.
13	V3_RFOUT2	3.15 V to 3.45 V Positive Power Supply Pin for the RFOUT 2 Buffer Circuitry. Short the V3_RFOUT2 pin to the other pins in the 3.3 V Power Supply Group 2.
15, 17	RFOUT2N, RFOUT2P	RF Output 2 Output Signal. The VCO output divider is buffered and presented differentially on the RFOUT2N and RFOUT2P pins. The outputs have a 50 Ω (typical) output resistance per side (100 Ω differential). The far end of the transmission line is typically terminated with 100 Ω connected across the outputs. The output amplitude is programmable via the serial port.
20, 22	RFOUT1N, RFOUT1P	RF Output 1 Output Signal. The VCO output divider is buffered and presented differentially on the RFOUT1N and RFOUT1P pins. The outputs have 50 Ω (typical) output resistance per side (100 Ω differential). The far end of the transmission line is typically terminated with 100 Ω connected across the outputs. The output amplitude is programmable via the serial port.
24	V3_RFOUT1	3.15 V to 3.45 V Positive Power Supply Pin for the RFOUT 1 Buffer Circuitry. Short the V3_RFOUT1 pin to the other pins in the 3.3 V Power Supply Group 2.
27	LKDET	PLL Lock Detect. This output presents the lock status of the PLL. The PLL is locked when LKDET is a logic high.
28	DELADJ	Delay Adjust Input Signal. Logic 0 ensures that the delay of the RF output signal is reduced after DELSTR is asserted. Logic 1 ensures that the delay of the RF output signal is increased after DELSTR is asserted.
29	DELSTR	Delay Strobe Input Signal. A rising edge on this signal indicates that an adjustment is needed. The adjustment is then made on the falling edge.
30	V3_LS	3.15 V to 3.45 V Positive Power Supply Pin for the Internal Level Shift Circuitry. Short the V3_LS pin to the other pins in the 3.3 V Power Supply Group 1.
31	CE	Chip Enable. 3.3 V CMOS input. Does not support 1.8 V CMOS levels. This CMOS input enables the device when driven high. A logic low disables the device, putting the device in a full power-down state causing the register to reset. Conversely, the PD_ALL bit powers down the device, but does not reset the registers.

PIN CONFIGURATION AND FUNCTION DESCRIPTIONS

Table 6. Pin Function Descriptions (Continued)

Pin No.	Mnemonic	Description
32	CSB	Serial Port Chip Select. This CMOS input initiates a serial port communication burst when driven low, ending the burst when driven back high.
33	SDIO	Serial Data Input/Output. CMOS input and output. When configured as an input, the serial port uses this CMOS input for data. In 3-wire readback mode (default mode), the SDIO pin outputs data from the serial port during a read communication burst.
34	SCLK	Serial Port Clock. This CMOS input clocks serial port input data on its rising edge.
35	SDO	Optional Serial Data Output. In 3-wire mode (default mode), this three-state CMOS pin remains in a high impedance state. In 4-wire readback mode, the SDO pin presents data from the serial port during a read communication burst. When the CSB is de-asserted, SDO returns to a high impedance. Optionally, attach a resistor of >200 k Ω to prevent a floating output.
36	V3_LDO	3.15 V to 3.45 V Positive Power Supply Pin for the Internal Low Dropout (LDO) Regulator Circuitry. Short the V3_LDO pin to the other pins in the 3.3 V Power Supply Group 1.
37	MUXOUT	Internal Device Multiplexor Output. This output pin can be connected to multiple internal nodes for factory test and debug purposes.
38, 39	SYNCP, SYNCN	Synchronization Input Signals. Both RF output signals are synchronized to an input signal at these pins. SYNCP and SYNCN are used for multichip phase synchronization. This differential input can accept both high and low common-mode input signals (based on the SPI bit setting).
40	V3_SYNC	3.15 V to 3.45 V Positive Power Supply. Short the V3_SYNC pin to the other pins in the 3.3 V Power Supply Group 1.
42, 43	REFP, REFN	Reference Input Signals. These differential inputs are buffered with a low noise amplifier (LNA) ideally suited for high slew rates (default mode). For low slew rate reference input signals, an alternate LNA can be selected via the serial port. Reference inputs are self biased and must be AC-coupled with 1 μ F capacitors. Reference inputs accept differential or single-ended inputs. See the Reference Input Network section for more details.
44	V3_REF	3.15 V to 3.45 V Positive Power Supply Pin for the PLL Reference Circuitry. Short the V3_REF pin to the other pins in the 3.3 V Power Supply Group 1.
45	V3_PFD	3.15 V to 3.45 V Positive Power Supply Pin for PFD Circuitry. Short the V3_PFD pin to the other pins in the 3.3 V Power Supply Group 1.
46	V5_CP	4.75 V to 5.25 V Positive Power Supply Pin for Charge Pump Circuitry. Isolate the V5_CP pin from the V5_VCO supply plane.
47	CP	Charge Pump Output. This bidirectional current output is normally connected to the external loop filter.
Exposed Pad	GND	Negative Power Supply (Ground). The package exposed pad must be soldered directly to the PCB land. The PCB land pattern must have multiple thermal vias to the ground plane for both low ground inductance and low thermal resistance.

TYPICAL PERFORMANCE CHARACTERISTICS

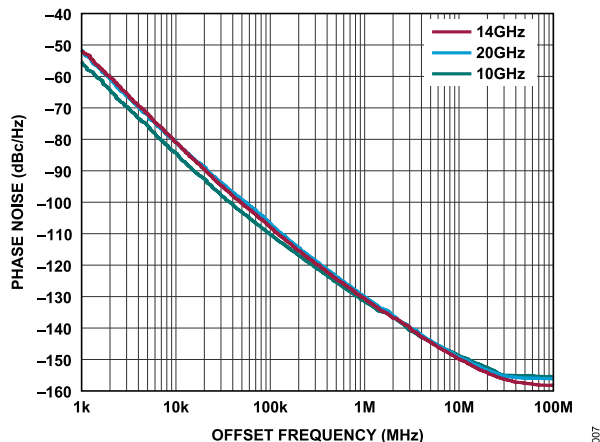

Figure 7. Open-Loop VCO Phase Noise vs. Offset Frequency at Various Frequencies

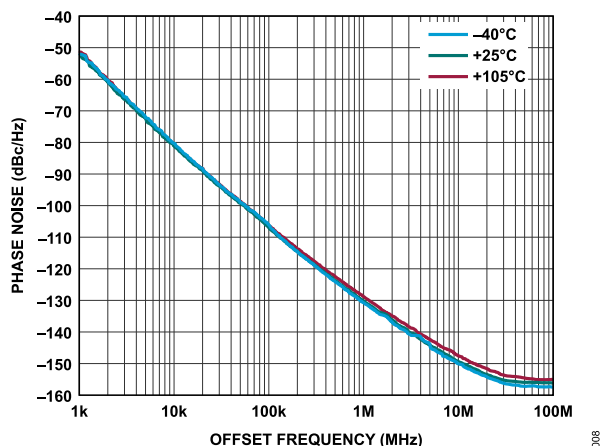

Figure 8. Open-Loop VCO Phase Noise vs. Offset Frequency at RFOUT = 20 GHz and Various Temperatures

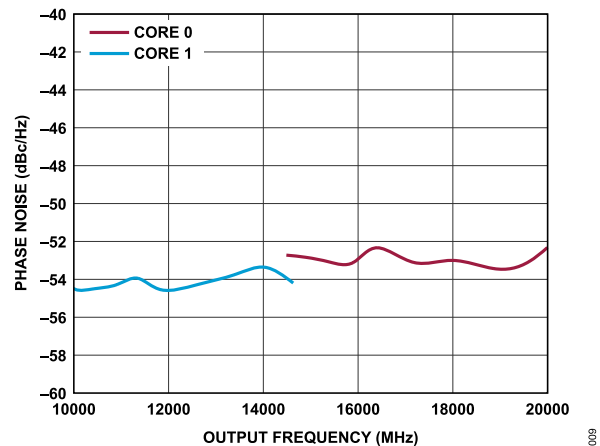

Figure 9. Open-Loop VCO Phase Noise Across Output Frequency at 1 kHz Offset

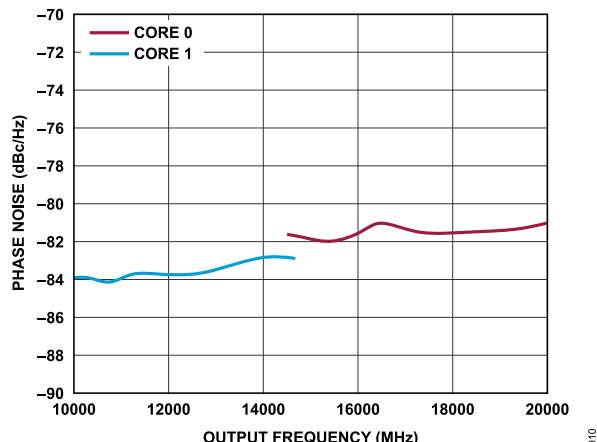

Figure 10. Open-Loop VCO Phase Noise Across Output Frequency at 10 kHz Offset

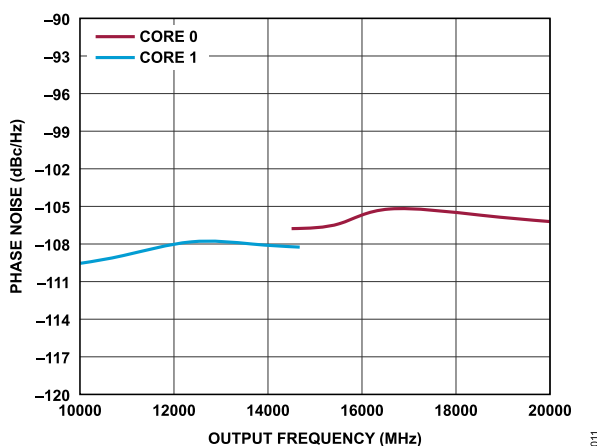

Figure 11. Open-Loop VCO Phase Noise Across Output Frequency at 100 kHz Offset

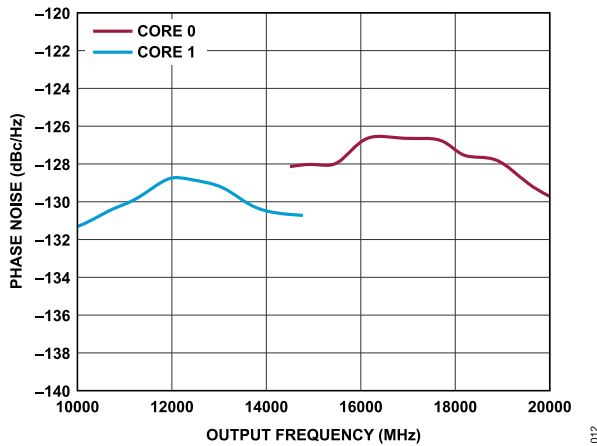

Figure 12. Open-Loop VCO Phase Noise Across Output Frequency at 1 MHz Offset

TYPICAL PERFORMANCE CHARACTERISTICS

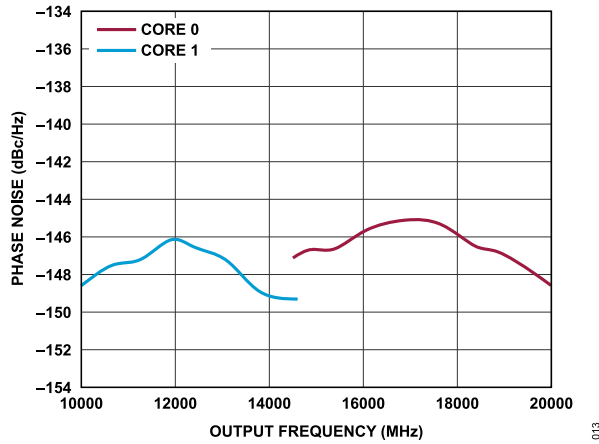

Figure 13. Open-Loop VCO Phase Noise Across Output Frequency at 10 MHz Offset

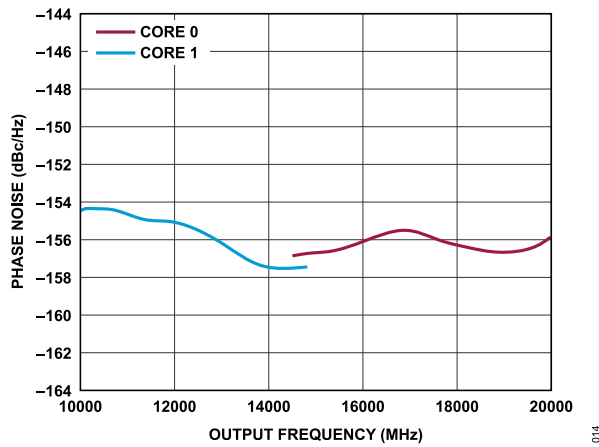

Figure 14. Open-Loop VCO Phase Noise Across Output Frequency at 100 MHz Offset

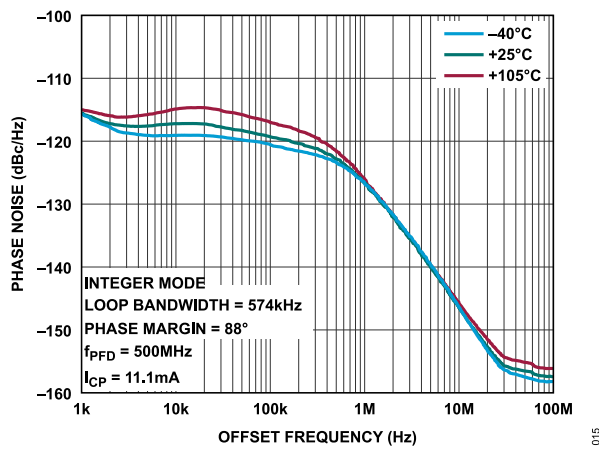

Figure 15. Closed-Loop Phase Noise vs. Offset Frequency at RFOUT = 14 GHz Across Temperatures

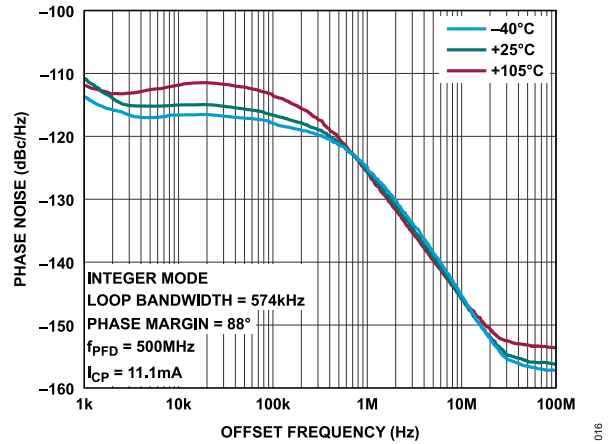

Figure 16. Closed-Loop Phase Noise vs. Offset Frequency at RFOUT = 20 GHz VCO Frequency Across Temperatures

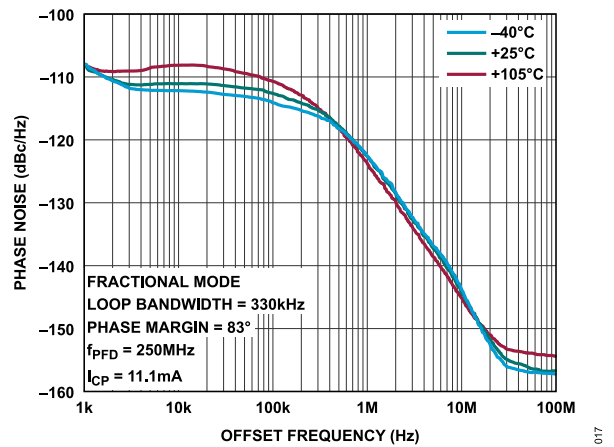

Figure 17. Closed-Loop Phase Noise vs. Offset Frequency at 19.9 GHz VCO Frequency Across Temperatures

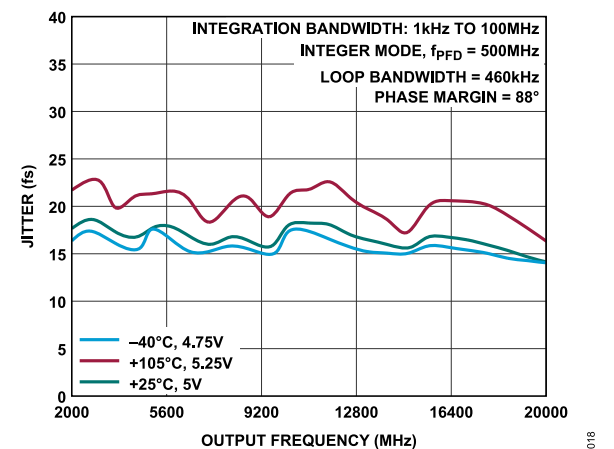

Figure 18. 1 kHz to 100 MHz Integrated Jitter in Integer Mode, $f_{PFD} = 500$ MHz

TYPICAL PERFORMANCE CHARACTERISTICS

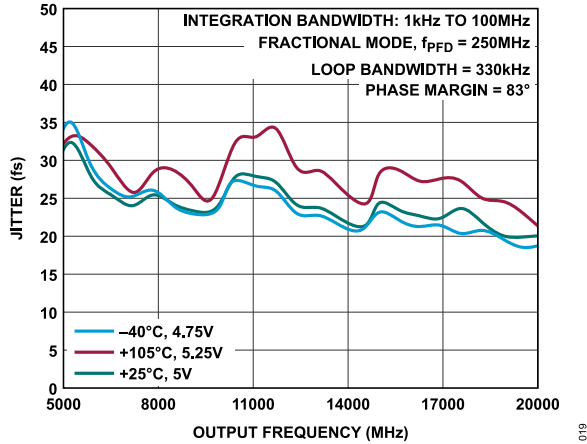

Figure 19. 1 kHz to 100 MHz Integrated Jitter in Fractional Mode, $f_{PFD} = 250$ MHz

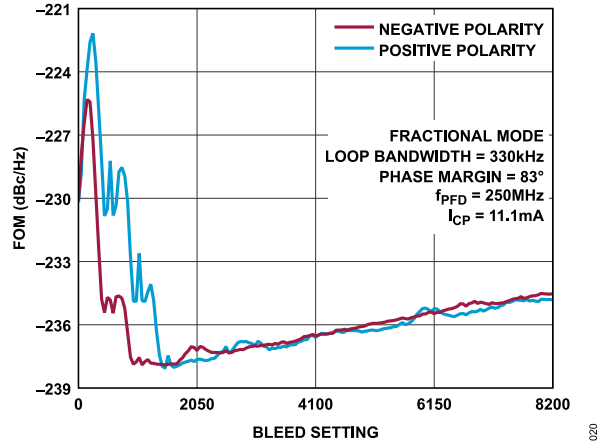

Figure 22. FOM, L_{NORM} Fractional Mode vs. Bleed Setting, $f_{PFD} = 250$ MHz, $R_{FOUT} = 19.9$ GHz

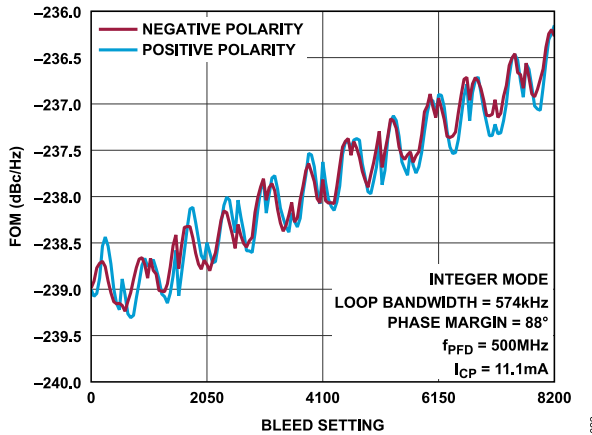

Figure 20. FOM, L_{NORM} Integer Mode vs. Bleed Setting, $f_{PFD} = 500$ MHz, $R_{FOUT} = 20$ GHz

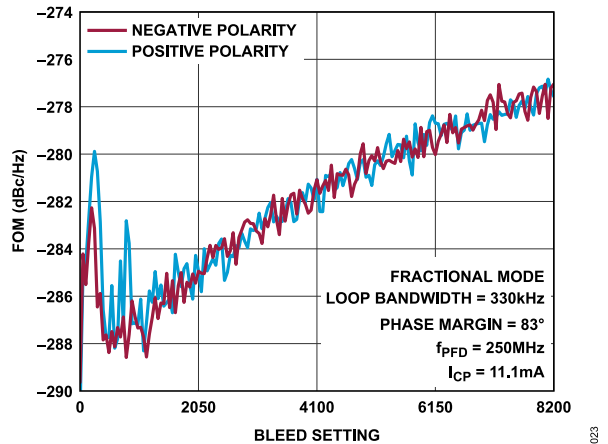

Figure 23. FOM, $L_{1/f}$ Fractional Mode vs. Bleed Setting, $f_{PFD} = 250$ MHz, $R_{FOUT} = 19.9$ GHz

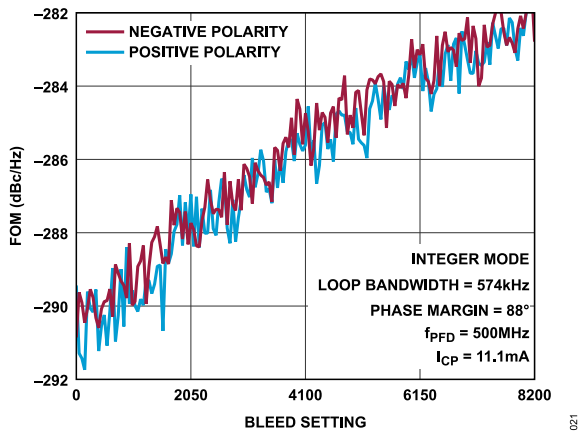

Figure 21. FOM, $L_{1/f}$ Integer Mode vs. Bleed Setting, $f_{PFD} = 500$ MHz, $R_{FOUT} = 20$ GHz

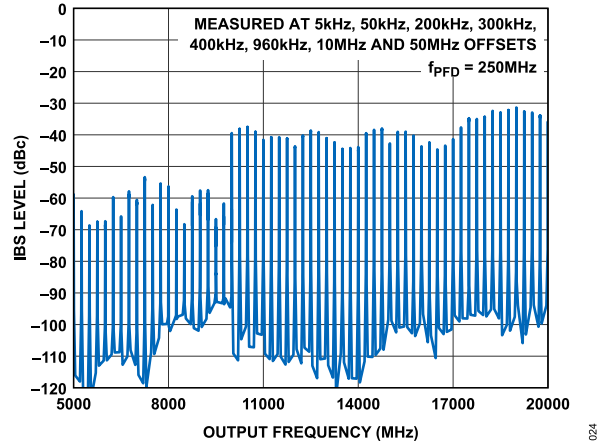

Figure 24. Worst Case Integer Boundary Spurs (IBS) Level vs. Output Frequency with $f_{PFD} = 250$ MHz

TYPICAL PERFORMANCE CHARACTERISTICS

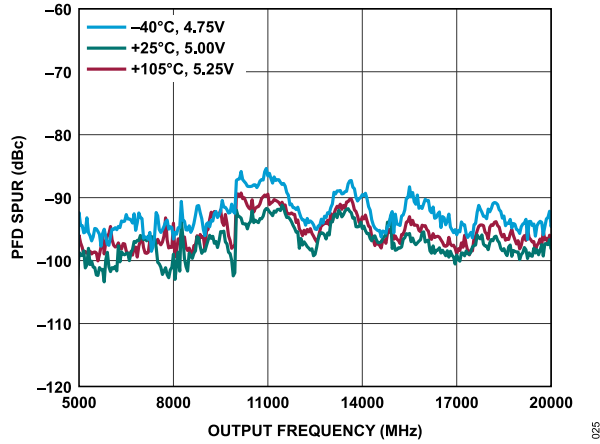

Figure 25. PFD Spur vs. Output Frequency at Various Temperatures and Voltages

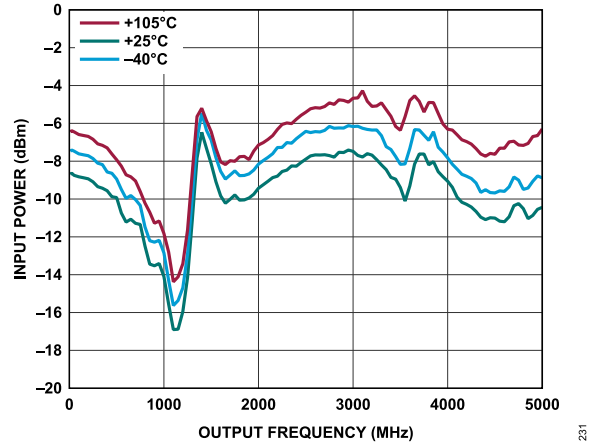

Figure 28. Minimum Input Signal for REF_OK = 1 for Delayed Match Amplifier (DMA) Buffer at Various Temperatures

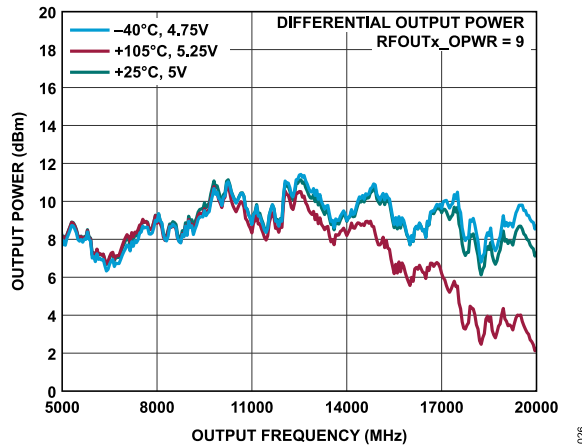

Figure 26. Differential Output Power vs. Output Frequency at Various Temperatures and Voltages

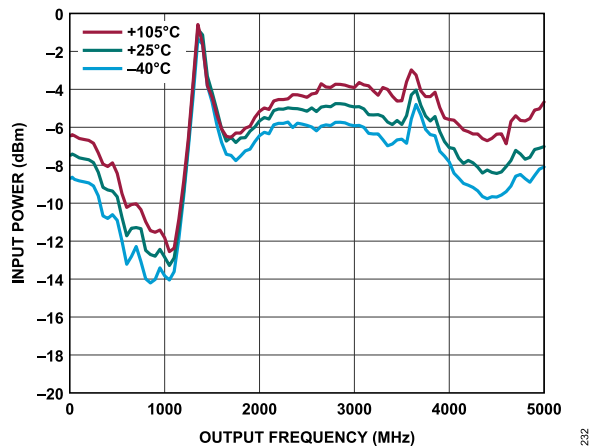

Figure 29. Minimum Input Signal for REF_OK = 1 for LNA Buffer at Various Temperatures

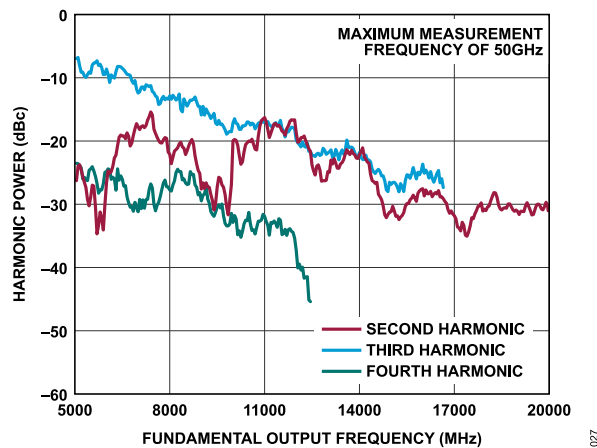

Figure 27. Harmonic Power vs. Fundamental Output Frequency

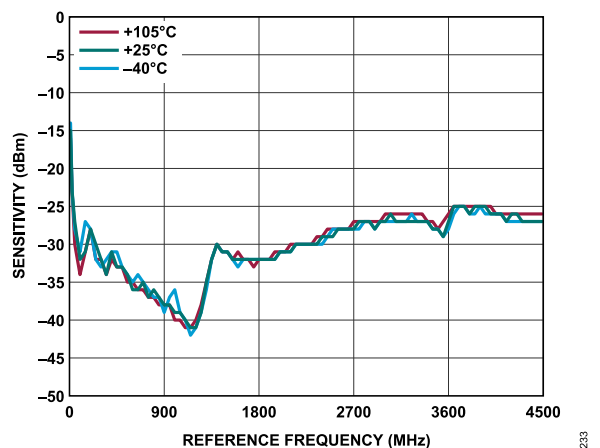

Figure 30. Reference Sensitivity for DMA Buffer at Various Temperatures

TYPICAL PERFORMANCE CHARACTERISTICS

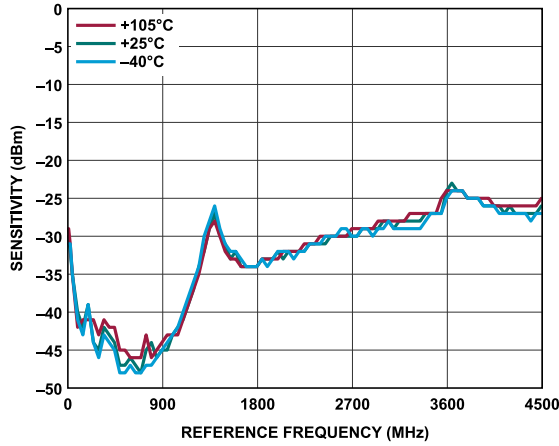

Figure 31. Reference Sensitivity for LNA Buffer at Various Temperatures

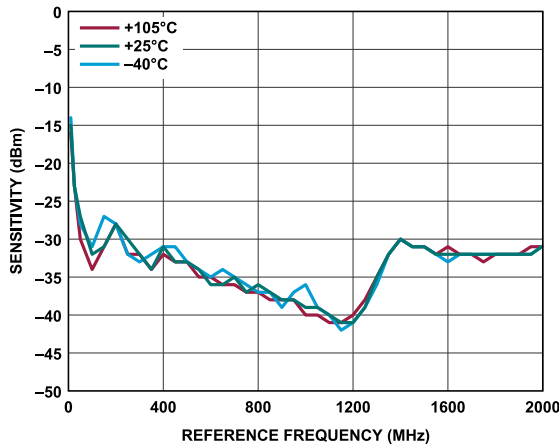

Figure 32. Reference Doubler Sensitivity for DMA Buffer at Various Temperatures

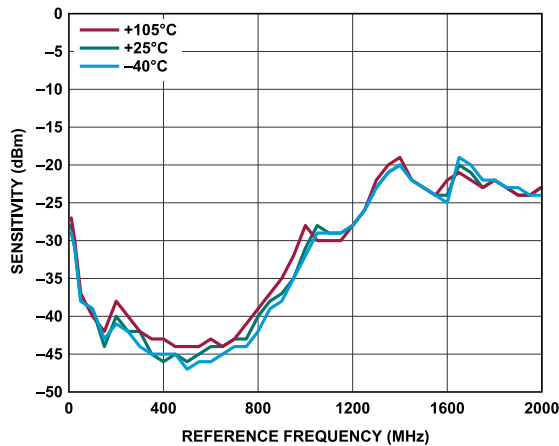

Figure 33. Reference Doubler Sensitivity for LNA Buffer at Various Temperatures

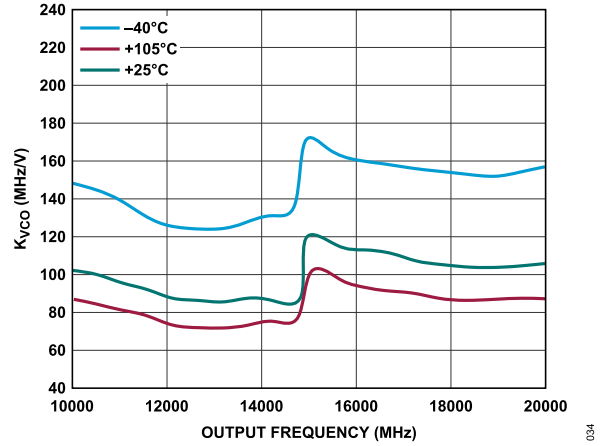

Figure 34. K_{VCO} vs. Output Frequency at Various Temperatures

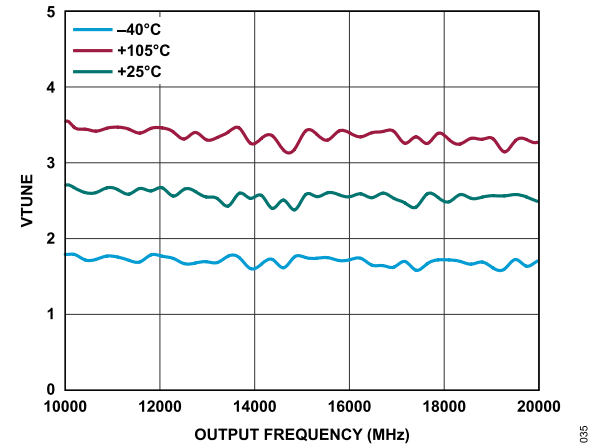

Figure 35. V_{TUNE} vs. Output Frequency at Various Temperatures

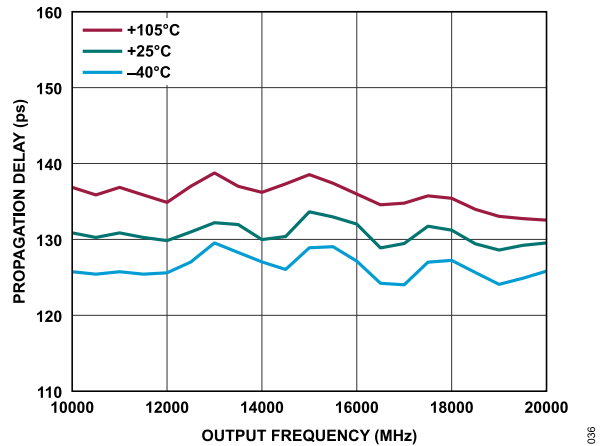

Figure 36. Propagation Delay vs. Output Frequency at Various Temperatures

TYPICAL PERFORMANCE CHARACTERISTICS

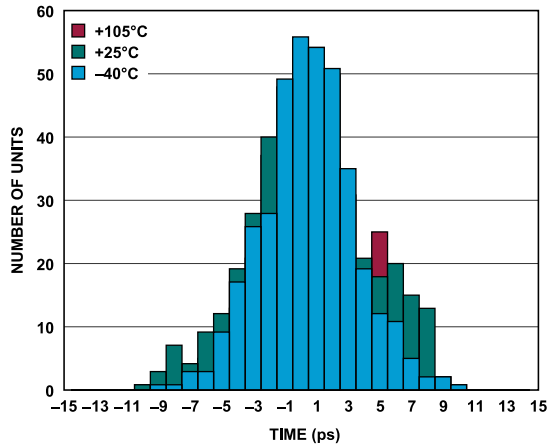

Figure 37. Normalized Propagation Delay (t_{PD}) Histogram

240

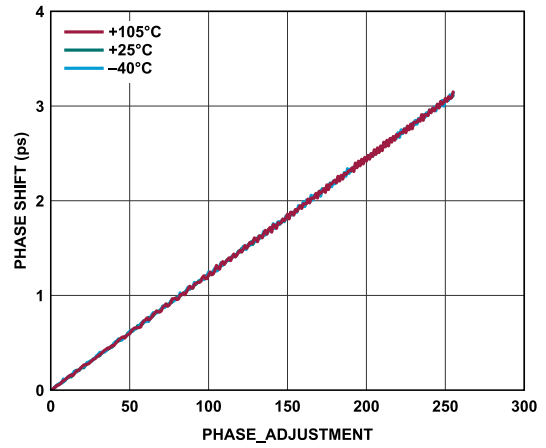

Figure 40. Phase Shift vs. PHASE_ADJUSTMENT for Various Temperatures

243

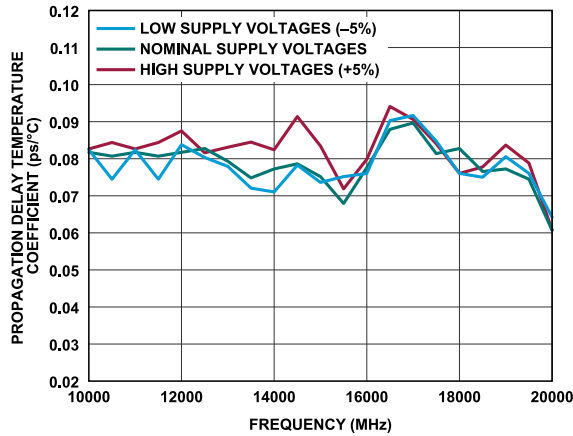

Figure 38. Propagation Delay Temperature Coefficient vs. Frequency

038

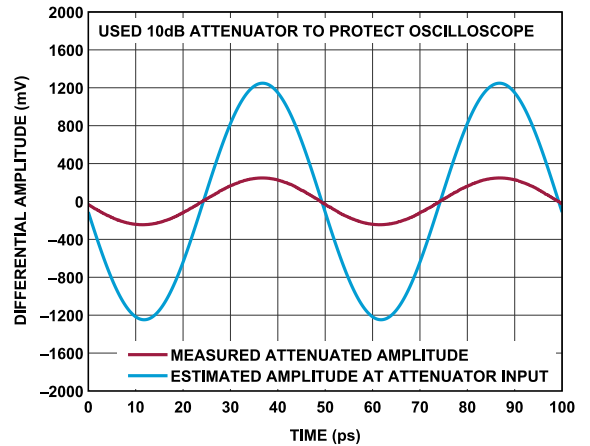

Figure 41. Differential Amplitude vs. Time at RFOUT = 20 GHz

246

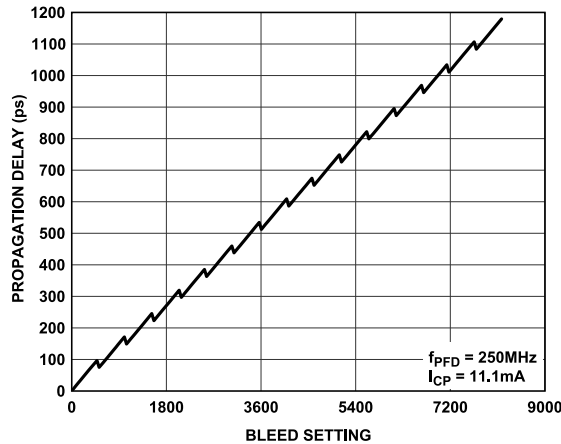

Figure 39. Propagation Delay vs. Bleed Setting

242

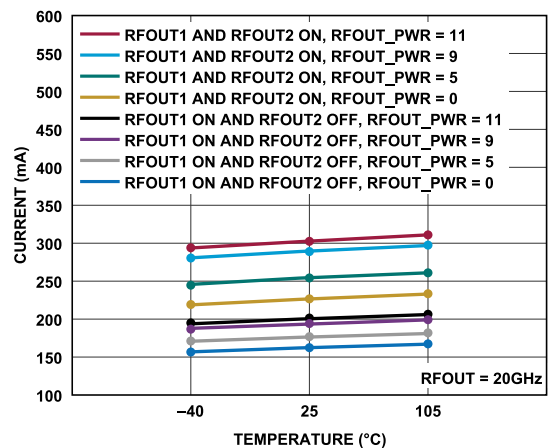

Figure 42. 3.3 V Supply Group 2 Current at Various Output Settings Across Temperature

247

TYPICAL PERFORMANCE CHARACTERISTICS

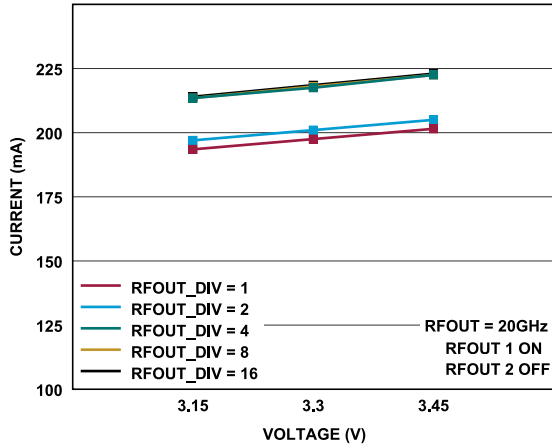

Figure 43. 3.3 V Supply Group 2 Current at Various Power Supply Voltages and RFOUT_DIV Settings

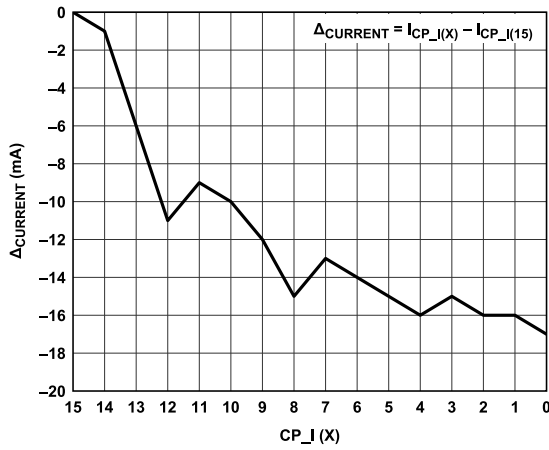

Figure 44. 5 V Delta Supply Current ($\Delta_{CURRENT}$) at Various CP_I Settings

THEORY OF OPERATION

INTRODUCTION

A PLL is a complex feedback system that can conceptually be considered a frequency multiplier. The system multiplies the frequency input at REFP/REFN and outputs a higher frequency at RFOUTxP/RFOUTxN. The PFD, charge pump, output divider, feedback divid-

er, VCO, and external loop filter form a feedback loop to accurately control the output frequency (see Figure 45). When operating in integer mode, the reference divider or reference doubler sets the frequency resolution. When operating in fractional mode, the fractional-N divider sets the frequency resolution.

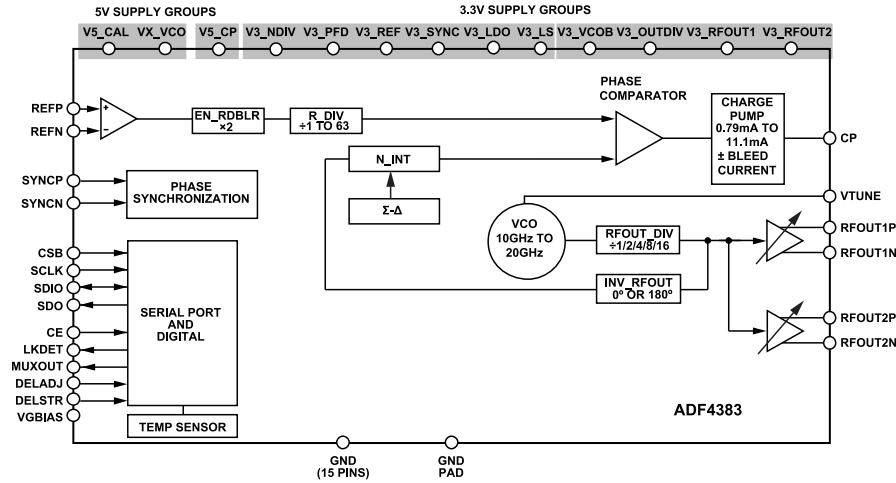

Figure 45. PLL Loop Diagram

THEORY OF OPERATION

OUTPUT FREQUENCY

When the loop is locked, the f_{VCO} (in Hz) produced at the output of the VCO is determined by f_{REF} and the O, R, and N values given by the following equation.

$$f_{VCO} = f_{REF} \times \frac{D \times N \times O}{R} \quad (1)$$

where:

f_{REF} is the reference frequency.

D is the reference doubler.

R is the reference divider.

O is the output divider.

f_{PFD} is given by the following:

$$f_{PFD} = \frac{f_{REF} \times D}{R} \quad (2)$$

and f_{VCO} can be alternatively expressed as follows:

$$f_{VCO} = f_{PFD} \times N \times O \quad (3)$$

The output frequency, f_{RFOUT} , produced at the output of the output divider is given by the following:

$$f_{RFOUT} = \frac{f_{VCO}}{O} \quad (4)$$

N is the feedback divider and is given by the following:

$$N = N_{INT} + \frac{FRAC1WORD + \frac{FRAC2WORD}{MOD2WORD}}{MOD1WORD} \quad (5)$$

CIRCUIT DESCRIPTION

Reference Input Buffer

The reference frequency of the PLL is applied differentially on the REFP and REFN pins. These high impedance inputs are self biased and must be AC-coupled with 1 μ F capacitors (see [Figure 46](#) for a simplified schematic). Alternatively, the inputs can be used single ended by applying the reference frequency at REFP and bypassing REFN to GND with a 1 μ F capacitor.

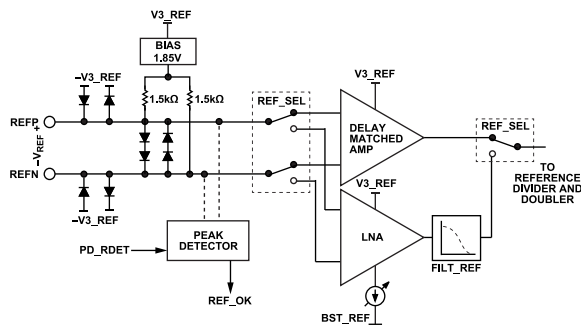

Figure 46. Reference Input Stage

A high quality signal must be applied to the REFP and REFN inputs as these inputs provide the frequency reference to the entire PLL. To achieve the in-band phase noise performance of the ADF4383, apply a continuous wave signal or a square wave with a slew rate of at least 1000 V/ μ s. See the [Reference Source Considerations](#) section for more information on reference input signal requirements and interfacing.

The REF_SEL bit (Register 0x030, Bit 5) can be set to either a CML reference input or sine wave or slow slew-rate reference input. When REF_SEL is set to 0, the delay matched amplifier (DMA) buffer is selected. The DMA is optimized for high slew rate signals, such as square waves or higher frequency and higher amplitude sine waves. The DMA has a controlled propagation delay from the reference input to clock output, which eases time zero and over temperature multichip clock alignment.

When the REF_SEL bit is set to 1, the LNA is selected. The LNA is optimized for low slew rate signals, such as lower frequency or lower amplitude sine waves.

The REF_SEL bit must be set correctly to optimize the in-band phase noise performance and propagation delay, t_{PD} . See [Table 7](#) for recommended settings.

Table 7. REF_SEL Programming

REF_SEL	Sine Wave Slew Rate (V/ μ s)	Square Wave	Optimized t_{PD}
0	≥ 1000	Preferred	Yes
1	< 1000	Not applicable	Not applicable

To calculate the slew rate of a sine wave, use the following equation:

$$\text{Slew Rate} = 2 \times \pi \times f \times V \quad (6)$$

where:

f is the sine wave frequency.

V is the sine wave amplitude (in V peak)

The FILT_REF bit (Register 0x02F, Bit 6) controls the reference input LPF of the LNA and must be set only for sine wave signals less than 20 MHz to limit the wideband noise of the reference. The FILT_REF bit must be set correctly to reach the normalized in-band phase noise floor (L_{NORM}). Square wave inputs have FILT_REF set to 0. [Table 8](#) shows the recommended settings.

Table 8. FILT_REF Programming

FILT_REF	Sine Wave f_{REF} (MHz)	Square Wave f_{REF}
0	≥ 20	All f_{REF}
1	< 20	Not applicable

The BST_REF bit (Register 0x02F, Bit 7) must be set based upon the input signal level to prevent the LNA reference input buffer from saturating. The BST_REF programming is the same whether the input is a sine wave or a square wave. See [Table 9](#) for recommended settings.

THEORY OF OPERATION

Table 9. BST_REF Programming

BST_REF	Sine Wave f_{REF} (Vref)
0	≥ 1.4 V p-p
1	< 1.4 V p-p

Reference Peak Detector

A reference input peak detection circuit is provided on the REFP and REFN inputs to detect the presence of a reference signal and provides the REF_OK status flag available through Bit 3, Register 0x058. The circuit has hysteresis to prevent the REF_OK flag from chattering at the detection threshold.

The peak detector approximates an RMS detector; therefore, sine and square wave inputs give different detection thresholds by a factor of $4/\pi$. See Table 10 for REF_OK detection values.

Table 10. REF_OK Status Output vs. Reference Input

REF_OK	Sine Wave f_{REF} (mV p-p)	Square Wave f_{REF} (mV p-p)
1	≥ 200	≥ 155
0	< 180	< 140

Reference Divider (R) and Doubler (D)

When the EN_RDBLR bit (Register 0x020, Bit 6) is set to 1, a frequency multiplier is used to double the frequency driven to the reference divider. A 6-bit divider, R_DIV (Register 0x020, Bits[5:0]), in series with reference doubler is used to reduce the frequency seen at the PFD. Its divide ratio, R, can be set to any integer from 1 to 63, inclusive. Use the R_DIV bits to directly program the R-divide ratio. See the Output Frequency section for the relationship between R and D and the f_{REF} , f_{PFD} , f_{VCO} , and f_{RFOUT} frequencies.

When using the reference doubler, refer to Table 11 for the required bit field settings that must be used for optimal jitter performance. Target reference frequency refers to the reference frequency after the doubler stage.

Table 11. Reference Doubler Settings

Target Reference Frequency	RDBLR_DEL_SEL	RDBLR_DC	INV_RDBLR
< 1 GHz	1	0	0
≤ 1.6 GHz	3	7	1
1.6 GHz to 4.5 GHz	1	0	1

Phase/Frequency Detector (PFD)

The PFD, in conjunction with the charge pump, produces source and sink current pulses proportional to the phase difference between the outputs of the reference divider or reference doubler and feedback divider. These source and sink pulses are required to phase lock the loop, forcing a phase alignment at the inputs of the PFD. See Figure 47 for a simplified schematic of the PFD.

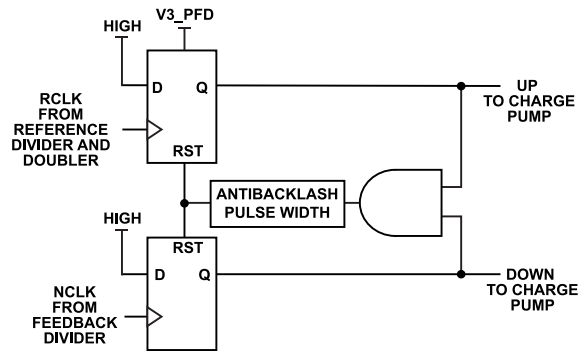

Figure 47. Simplified PFD Schematic

Charge Pump

The charge pump, controlled by the PFD, forces sink (down) or source (up) current pulses onto the CP pin, which must be connected to an appropriate loop filter. See Figure 48 for a simplified schematic of the charge pump.

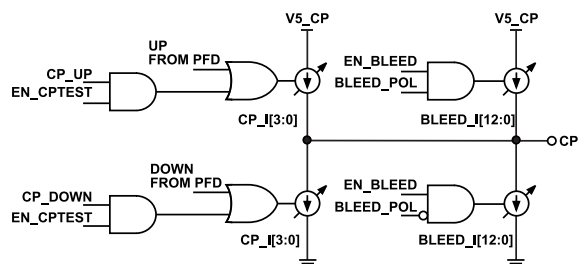

Figure 48. Simplified Charge Pump Schematic

The output current magnitude I_{CP} can be set from 0.79 mA to 11.1 mA using the CP_I bits (Register 0x001F, Bits[3:0]). A larger I_{CP} can result in lower in-band noise due to the lower impedance of the loop filter components, while a smaller I_{CP} can result in better spurious performance. See Table 12 for charge pump programming values.

Table 12. CP Programming

CP_I, Bits[3:0]	I_{CP} (mA)
0	0.79
1	0.99
2	1.19
3	1.38
4	1.59
5	1.98
6	2.39
7	2.79
8	3.18
9	3.97
10	4.77
11	5.57
12	6.33
13	7.91

THEORY OF OPERATION

Table 12. CP Programming (Continued)

CP_I, Bits[3:0]	I _{CP} (mA)
14	9.51
15	11.1

Charge Pump Test Mode

When the EN_CPTTEST bit (Register 0x02E, Bit 2) is set to 1, the CP_UP and CP_DOWN bits (Bit 1 and Bit 0, respectively) in the same register can be programmed to force a constant I_{CP} source or sink current, respectively, on the CP pin. The EN_CPTTEST or CP_UP and CP_DOWN bits must be set to 0 to allow the loop to lock. These bits can be used as an aid to debug PLL-related issues during the hardware and software development phase of a project. For normal operation, set EN_CPTTEST, CP_UP, and CP_DOWN to 0.

Table 13. Charge Pump Test Mode

EN_CPTTEST	CP_UP	CP_DOWN	CP Pin State	Debug Test
1	0	0	High-Z	VCO open loop
1	1	0	~V _{V5_CP}	Charge pump output voltage verification
1	0	1	~GND	Charge pump output voltage verification
0	0	0	Normal operation	Not applicable

Charge Pump Bleed Current Optimization

A small programmable constant charge pump current, known as bleed current, can be used to optimize the phase noise and fractional spurious signals in fractional mode, which also changes the propagation delay (t_{BLEED}) from the REFP and REFN input pins to the RFOUTP and RFOUTN output pins. In fractional mode, after setting the bleed current for best performance, the output can be shifted by using the phase word which is effectively used in the Σ-Δ modulator (SDM). In integer mode, bleed current can be used to shift the output in both directions.

To enable the bleed current, set the EN_BLEED bit to 1. When the BLEED_POL bit is set to 1, a small constant source current is forced onto the CP pin. When the BLEED_POL bit is set to 0, a small constant sink current is forced onto the CP pin.

The 13-bit bit field BLEED_I (Register 0x01D, Bits[7:0] and Register 0x01E, Bits[4:0]) is used to select the bleed current. This bit field consists of both a coarse bleed and a fine bleed value. The 4 MSBs are used to calculate the coarse bleed current, and the 9 LSBs are used to calculate the fine bleed current as shown in the following equations.

$$I_{COARSE\ BLEED} = COARSE_BLEED \times 202 \mu A \quad (7)$$

$$I_{FINE\ BLEED} = FINE_BLEED \times 567 \text{ nA} \quad (8)$$

$$I_{TOTAL\ BLEED} = I_{COARSE\ BLEED} + I_{FINE\ BLEED} \quad (9)$$

The propagation delay of the output frequency corresponds to the t_{TOTAL BLEED} as follows:

$$t_{BLEED} = \frac{I_{TOTAL\ BLEED}}{I_{CP}} \times t_{PFD} \quad (10)$$

where:

I_{COARSE BLEED} is the coarse bleed current.

COARSE_BLEED represents the 4 upper MSBs of the BLEED_I bit field.

I_{FINE BLEED} is the fine bleed current.

FINE_BLEED represents the lower 9 LSBs of the BLEED_I bit field.

I_{CP} is the charge pump current value selected.

THEORY OF OPERATION

Bleed Current Modes

The ADF4383 spurious performance can be optimized by programming t_{BLEED} setting based on the frequency of operation. The recommended t_{BLEED} for the RFOUT frequency of operation for each of the SDM modes are shown in Table 14.

To calculate the required BLEED_I setting required for a specific t_{BLEED} with the bleed current refer to Charge Pump Bleed Current Optimization section. Figure 49 provides a quick reference for delay step sizes for different charge pump settings and f_{PFD} frequencies.

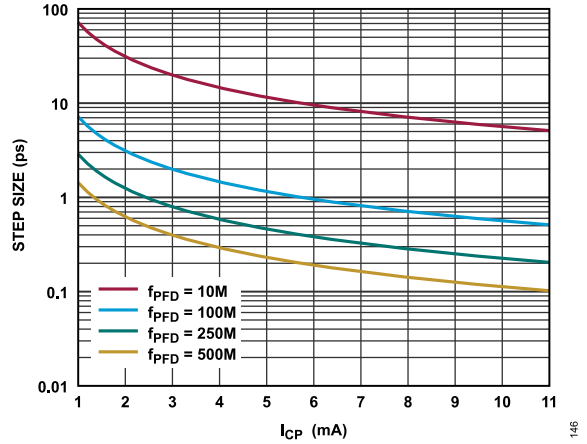

Figure 49. Bleed Current Delay Step Size

Table 14. Bleed Setting vs. Frequency for Each SDM Mode

RFOUT	t_{BLEED} (ps)		
	SDM Mode 0	SDM Mode 4	SDM Mode 5
RFOUT \geq 10 GHz	300	510	720
3.996 GHz \leq RFOUT < 10 GHz	625	625 + (2/RFOUT)	900 + (1.7/RFOUT)
1.8 GHz \leq RFOUT < 3.996 GHz	1000	1350	1400 + (4/RFOUT)
RFOUT < 1.8 GHz	3600	3600	3600 + (4/RFOUT)

THEORY OF OPERATION

Lock Detector

The lock detector uses internal signals from the PFD to measure the phase difference between the output signal of the reference divider and doubler (RCLK) and the output signal of the feedback divider (NCLK) in Figure 47. This detector is enabled by setting both the EN_LOL and EN_LDWIN bits (Register 0x02D, Bit 5 and Bit 4, respectively) to 1 and presents the lock detector output on the LKDET pin (Pin 27) and the LOCKED bit (Register 0x58, Bit 0). The lock detector output can also be presented on the MUXOUT pin (Pin 37 by programming the MUXOUT bits in Register 0x2E, Bits[7:4], to b0001).

The PFD RCLK and NCLK phase difference must be less than the phase difference lock window time, t_{LDWIN} , for a set number of PFD cycles before the lock detector output indicates the PLL has locked. The desired number of PFD cycles vary depending on whether the lock detect accuracy or speed is prioritized. Five loop filter time constants can be used as an initial estimate of the desired number of PFD cycles, as shown in the following equation:

$$PFD\ Cycles = \frac{5}{2 \times \pi \times LFBW} \times f_{PFD} \quad (11)$$

where LFBW means loop filter bandwidth.

Note that LD_COUNT bits (Register 0x02C, Bits[4:0]) are used to select the desired number of PFD cycles. Use Table 15 to select the LD_COUNT value for the desired number of PFD cycles.

Table 15. LD_COUNT Programming

LD_COUNT[4:0]	PFD Cycles
0	27
1	35
2	51
3	67
4	99
5	131
6	195
7	259
8	387
9	515
10	771
11	1027
12	1539
13	2051
14	3075
15	4099
16	6147
17	8195
18	12291
19	16387
20	24579
21	32771
22	49155

Table 15. LD_COUNT Programming (Continued)

LD_COUNT[4:0]	PFD Cycles
23	65539
24	98307
25	131075
26	196611
27	262147
28	393219
29	524291
30	786345
31	1048579

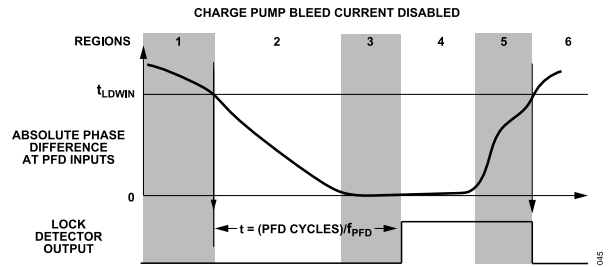

Figure 50. Lock Detector Timing, Bleed Current Disabled

Table 16. Lock Detector Timing, Bleed Current Disabled

Region	Absolute Phase Difference at PFD	Lock Detector State
1	$>t_{LDWIN}$	Low
2	$<t_{LDWIN}$	Low, counts PFD cycles
3	~ 0	Low, counts PFD cycles
4	~ 0	High, greater than or equal to the desired PFD cycle count
5	$<t_{LDWIN}$	High
6	$>t_{LDWIN}$	Low (immediately)

When the charge pump bleed current is enabled, a phase offset is applied to the PFD inputs. This phase offset, t_{IDEL} , is proportional to the amount of bleed current. Region 3 and Region 4 in Figure 50 and Figure 51 highlight the PFD phase difference the PLL settles to when the charge pump bleed current is disabled or enabled, respectively.

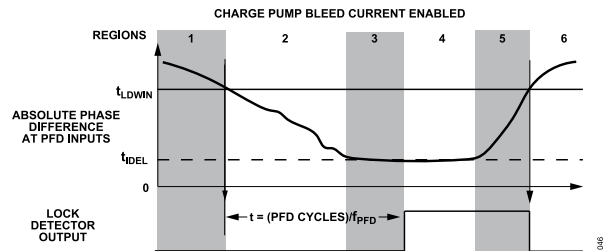

Figure 51. Lock Detector Timing, Bleed Current Enabled

For proper operation of the lock detector, the absolute value of t_{IDEL} must be less than t_{LDWIN} . The user sets the phase difference lock

THEORY OF OPERATION

window time (t_{LDWIN}) for a valid lock condition with the LDWIN_PW bit field (Register 0x02C, Bits[7:5]).

Table 17. LDWIN_PW Programming

LDWIN_PW [7:5]	Mode of Operation
000	Integer mode, 500 MHz maximum PFD with bleed ≤ 85 ps
001	Integer mode, 500 MHz maximum PFD with bleed > 85 ps
010	Fractional mode, 250 MHz maximum PFD, RFOUT ≥ 6.4 GHz
011	Fractional mode, 250 MHz maximum PFD, RFOUT ≥ 5 GHz
100	Fractional PLL, 200 MHz maximum PFD, RFOUT ≥ 4 GHz
101	Fractional PLL, 100 MHz maximum PFD, RFOUT ≥ 2 GHz
110	Fractional PLL, 50 MHz maximum PFD, RFOUT ≥ 1 GHz
111	Fractional PLL, 40 MHz maximum PFD, RFOUT ≥ 800 MHz

MUXOUT

The state of the MUXOUT pin is determined by the MUXOUT bits (Register 0x02E, Bits[7:4]), which allow the user access to various internal nodes. The MUXOUT pin and MUXOUT bits are commonly used as an additional lock status output or to debug PLL-related issues during the hardware and software development phase of a project. The CMOS_OV bit (Register 0x03D, Bit 5) determines if the logic high level for the MUXOUT pin, LKDET pin, SDO pin, and SDIO pin is 3.3 V or 1.8 V.

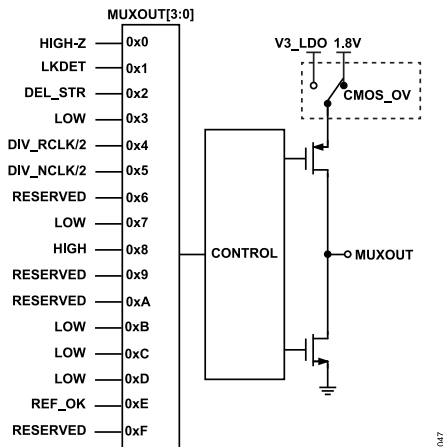

Figure 52. MUXOUT

Temperature Sensor

The temperature sensor is composed of an 8-bit ADC, which measures the proportional to absolute temperature (PTAT) voltage with respect to the reference voltage (VREF) of a bandgap. The purpose of the temperature sensor is to measure changes in the die temperature and not the absolute junction temperature. The maximum ADC clock frequency is 400 kHz. The ADC clock is generated from the RCLK.

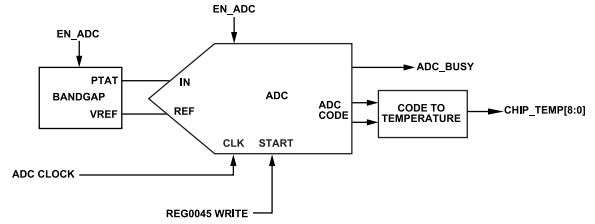

Figure 53. Temperature Sensor

Before an ADC measurement can occur, program the registers of the ADF4383 as shown in Table 18.

Table 18. ADC Register Setup

Bit Fields	Value
EN_DRCLK, EN_DNCLK, EN_ADC_CNV	1
ADC_ST_CNV, EN_ADC, EN_ADC_CLK	1
PD_ADC	0

After the bits in Table 18 are programmed, start an ADC conversion with a register write to Register 0x054 setting ADC_ST_CNV = 1. An ADC conversion requires 17 clock cycles to complete. In Register 0x058, Bit 2, the ADC_BUSY bit monitors the conversion status. During a conversion, ADC_BUSY is set to 1, and when the conversion is complete, ADC_BUSY is set to 0. Measurements are recorded in the CHIP_TEMP bit field, Bits[8:0], in Register 0x05B and Register 0x05C. The value read back represents the junction temperature in degrees celsius. The MSB (Bit 8) indicates positive or negative temperature i.e. when Bit 8 = 1, the temperature read back is negative.

Double Buffering

Double buffering refers to a main and subordinate configuration for the bit fields shown in Table 19.

Only the subordinate bit fields control the actual state of the ADF4383. When double buffering is enabled for a bit field, the serial interface only writes to the main bit field. The subordinate bit field retains its previous value until a register write is sent to Register 0x010. After writing to Register 0x010, all the main bit fields are automatically loaded to their respective subordinate bit fields. Writing to Register 0x010 also starts the autocalibration of the VCO (see the Standard Power-Up and Initialization Sequence, Automatic VCO Calibration section), which allows the user to update several bit fields that change the output frequency of the ADF4383 and starts a new VCO calibration on the same register write. When double buffering is disabled, the SPI writes directly to the subordinate bit field.

Table 19. Double Buffer Enabled Bit Fields

Double Buffer Enabled Bits	Double Buffered Bit Fields
Not Applicable, Always Enabled	N_INT, R_DIV, EN_RDBLR, CP_I
RFOUTODIV_DB	RFOUT_DIV
DCLK_DIV_DB	DCLK_DIV1

THEORY OF OPERATION

Table 19. Double Buffer Enabled Bit Fields (Continued)

Double Buffer Enabled Bits	Double Buffered Bit Fields
DEL_CTRL_DB	INV_RFKOUT, BLEED_I, BLEED_POL

Serial Port

The SPI-compatible serial port provides control and monitoring functionality. The CMOS_OV bit (Register 0x03D, Bit 5) determines if the logic high level for the SDO and SDIO SPI output pins is 3.3 V or 1.8 V. The CMOS_OV bit also sets the output level for the MUXOUT and LKDET pins.

The serial port can be programmed to support several different configurations in Register 0x000 and Register 0x001.

The SDO_ACTIVE bit (Register 0x000, Bit 3) determines if the serial port is configured as a 3-wire or 4-wire serial interface (see the timing diagrams in Figure 2, Figure 3 and Figure 4).

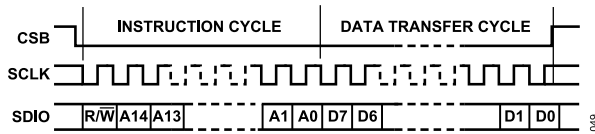

Figure 54. Serial Interface, MSB First (LSB_FIRST = 0)

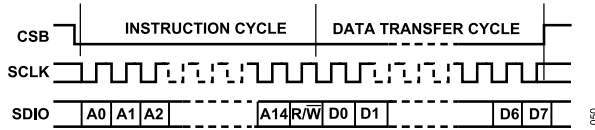

Figure 55. Serial Interface, LSB First (LSB_FIRST = 1)

The SPI register map can be programmed with single instructions, as shown in Figure 54 and Figure 55, or in streaming mode. Streaming mode allows for efficient data transfer read or write cycles to multiple registers. Streaming mode allows the user to program a bit stream composed of one register address in the instruction header and data for that register address, which is then followed by data in subsequent register addresses.

VCO

The VCO core consists of two separate VCOs both of which uses 512 overlapping bands, which allows the device to cover a wide frequency range without large VCO tuning sensitivity (K_{VCO}). The

output frequency can be further extended by utilizing the output divider.

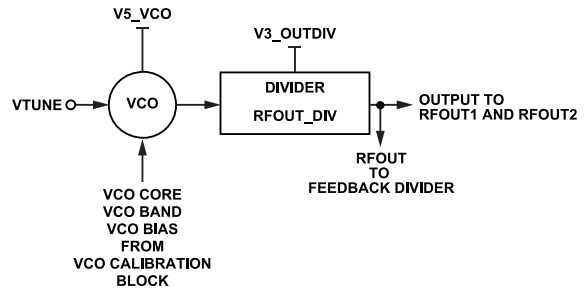

Figure 56. VCO and Clock Output Divider

The correct VCO core, band, and bias are chosen automatically by performing a VCO calibration. After a VCO calibration is performed for a specific frequency, the VCO core, band, and bias values can be recorded for that particular device. These values can be programmed manually later when the same device and frequency are used, thereby avoiding the VCO calibration time.

VCO Calibration

A VCO calibration is required to select the correct VCO core, band, and bias settings for a specific VCO frequency. This procedure assumes that the device is powered up, the desired reference frequency is present on the REFP and REFN pins, and all other registers are programmed correctly. Figure 57 and Figure 58 are provided as visual aids for this procedure.

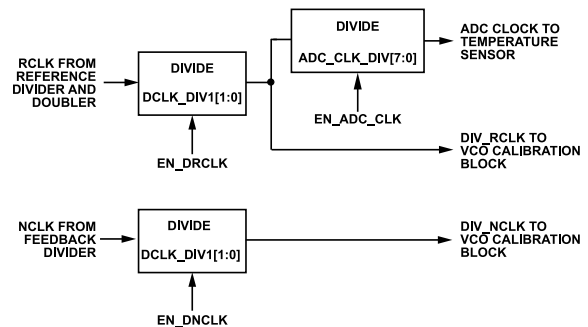

Figure 57. VCO Calibration Dividers

THEORY OF OPERATION

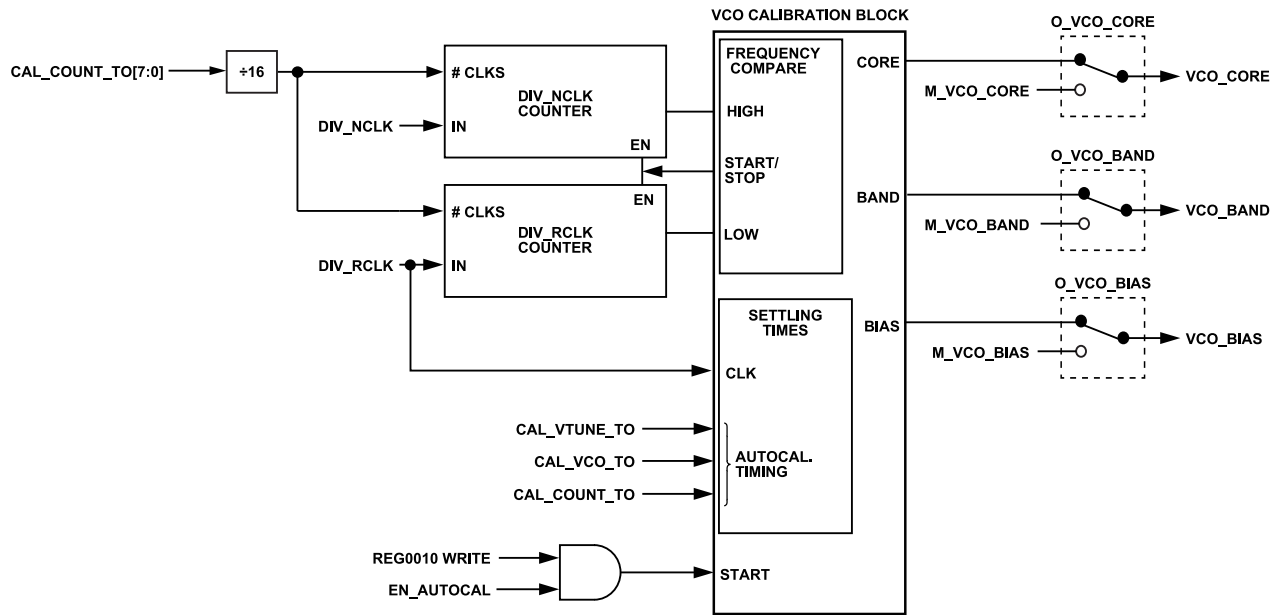

Figure 58. VCO Calibration Block

The following calibration timeout bit fields must be programmed for autocalibration:

- ▶ **CAL_VTUNE_TO:** At the beginning of the calibration, VTUNE is precharged to a nominal voltage, which is dependent on the temperature of operation. CAL_VTUNE_TO sets the precharge time as follows:

$$CAL_VTUNE_TO = Ceiling \left(\frac{CAL_VTUNE_TO\ Time \times f_{PFD}}{2^{DCLK_DIV1}} \right) \quad (12)$$

The largest value capacitor in the loop filter directly affects the time taken to precharge to VTUNE. Refer to the [Calibration Time Performance Consideration](#) section to calculate the CAL_VTUNE_TO time required. This time is used as the Target VTUNE Calibration Timeout.

- ▶ **CAL_COUNT_TO:** This is used to calculate the target band decision timeout. During autocalibration, there are nine band decisions to be made to select the final band of operation for the selected frequency. CAL_COUNT_TO is used to program the time taken for each band decision. This time affects the calibration accuracy. See [Table 21](#) for the recommended CAL_COUNT_TO time. Use the following equation to set the decision time of each band:

$$CAL_COUNT_TO = Ceiling \left(\frac{CAL_COUNT_TO\ Time \times f_{PFD}}{2^{DCLK_DIV1} \times 16} \right) \quad (13)$$

- ▶ **CAL_VCO_TO:** This bit field is used to set the target VCO frequency settling timeout after each band decision. As per [Table 21](#) the recommended CAL_VCO_TO time is 1µs. To set this time, use the following equation:

$$CAL_VCO_TO = Ceiling \left(\frac{CAL_VCO_TO\ Time \times f_{PFD}}{2^{DCLK_DIV1}} \right) \quad (14)$$

To perform a VCO calibration, set up the following several registers as outlined in the following procedure:

1. Set DCLK_DIV1 and DCLK_MODE to the values listed in [Table 20](#) and record f_{DIV_RCLK} for later use.
2. Calculate and set the minimum required values for CAL_VTUNE_TO, CAL_VCO_TO, and CAL_COUNT_TO as per their corresponding formulas previously described in this section.
3. Set the N_INT, RFOUT_DIV, and R_DIV bits and the EN_RDBLR bit by programming Register 0x010 last. Any writes to Register 0x010 start the VCO autocalibration.
4. Monitor the ADC_BUSY bit and FSM_BUSY bit (Register 0x058, Bit 2 and Bit 3, respectively). The calibration is finished when ADC_BUSY transitions from high to low, followed with FSM_BUSY transitioning from high to low.
5. After the VCO calibration is complete, disable the calibration clocks to limit unwanted spurious content by setting EN_DRCLK = EN_DNCLK = 0.

Table 20. DCLK_DIV1 and DCLK_MODE Setup

f _{PFD} (MHz)	DCLK_DIV1	DCLK_MODE	f _{DIV_RCLK} (MHz)
≤11	0	0	f _{PFD}
>11 and ≤160	0	1	f _{PFD} /2
>160 and ≤320	1	1	f _{PFD} /4
>320	2	1	f _{PFD} /8

THEORY OF OPERATION

Total Autocalibration Time

Use each of the calibration timeout values to calculate the total autocalibration time as follows:

$$\text{Total Autocalibration Time} = \text{CAL_VTUNE_TO Time} + \left(\frac{2}{f_{DIV_RCLK}} \right) + (10 \times \text{VCO Band Decision Time}) + \text{VCAL Time} \quad (15)$$

where:

$$\text{VCO Band Decision Time} = \text{CAL_VCO_TO Time} + \text{CAL_COUNT_TO Time} + \left(\frac{5}{f_{DIV_RCLK}} \right) \quad (16)$$

$$f_{DIV_RCLK} = \frac{f_{PFD}}{2 \text{DCLK_DIV1} + \text{DCLK_MODE}} \quad (17)$$

$$\text{VCAL Time} = \frac{2}{f_{DIV_RCLK}} \quad (18)$$

Calibration Time Performance Consideration

When programming the VCO calibration time as per the [VCO Calibration](#) section, the jitter performance can be affected by the overall calibration time. For applications where taking a longer time for calibration is not an issue, for example, fixed frequency applications, it is recommended to program an autocalibration time of 250 μs to optimize jitter and phase noise performance. For other applications requiring faster autocalibration times and reduced overall lock times, an autocalibration time of 100 μs can be used. However, this time may degrade jitter with temperature changes over the complete -40°C to $+105^{\circ}\text{C}$ operating range.

Table 21. Recommended Calibration Times

Autocalibration Time (μs)	CAL_VTUNE_TO Time	CAL_COUNT_TO Time (μs)	CAL_VCO_TO Time (μs)
100	Determined by the largest loop filter capacitor	8.5	1
250	Determined by the largest loop filter capacitor	23.5	1

Core Bias Table

As part of the initialization process, the core bias table must be programmed with the predefined values provided in the [Register Map](#) section (see Register 0x100 through Register 0x111). These are specifically optimized VCO bias values for different frequency bands of operation. After performing a device initialization, the VCO bias registers are not reprogrammed until a subsequent power-on reset executes.

RF Output Divider (O)

A 3-bit divider, RFOUT_DIV (Register 11, Bits[7:5]), is used to divide the frequency seen at the output buffer and feedback divider. The divide ratio can be set to 1, 2, 4, 8, or 16. See [Table 22](#) for details on divider settings. RFOUT_DIV is located inside the PLL. Therefore, any change to RFOUT_DIV requires a change to the N_INT bit fields (Register 0x010, Bits[7:0] and Register 0x011, Bits[3:0]) to maintain the same f_{PFD} and results in the PLL losing lock for a few loop time constants.

Table 22. RFOUT_DIV Programming

RFOUT_DIV	Divisor	Output Frequency Range (GHz)
0	1	$10 \leq \text{RFOUT} \leq 20$
1	2	$5 \leq \text{RFOUT} < 10$
2	4	$2.5 \leq \text{RFOUT} < 5$
3	8	$1.25 \leq \text{RFOUT} < 2.5$
4	16	$0.625 \leq \text{RFOUT} < 1.25$

Output Invert (INV_RFOUT)

The output invert, INV_RFOUT (Register 0x011, Bit 4), is used to shift the output signal 180° . INV_RFOUT is located inside the PLL, and any change to INV_RFOUT results in the PLL losing lock for a few loop time constants.

Feedback Divider (N)

The feedback divider provides a division ratio in the PLL feedback path. The division ratio consists of the N_INT (Register 0x011, Bits[3:0] and Register 0x010, Bits[7:0]), FRAC1WORD (Register 0x15, Bit 0; Register 0x14, Bits[23:16]; Register 0x013, Bits[15:8], and Register 0x012, Bits[7:0]), FRAC2WORD (Register 0x19, Bits[23:16]; Register 0x18, Bits[15:8]; and Register 0x17, Bits[7:0]), and MOD2WORD (Register 0x1C, Bits[23:16]; Register 0x1B, Bits[15:8]; and Register 0x1A, Bits[7:0]) bit field values that this divider comprises together with the fixed modulus MOD1WORD (2^{25}). See the [Output Frequency](#) section for the relationship between N_INT, FRAC1WORD, MOD1WORD, FRAC2WORD, MOD2WORD, RFOUT_DIV, together with R and D, and the f_{REF} , f_{PFD} , f_{VCO} and f_{OUT} frequencies.

Phase Adjust

One of the following two methods can be used to perform a phase adjustment of the RFOUT signals relative to their initial phase:

- ▶ Bleed current mode
- ▶ Σ - Δ mode

To enable bleed current mode, set DEL_MODE = 0. To enable Σ - Δ mode, set DEL_MODE = 1.

THEORY OF OPERATION

Bleed Current Phase Adjustment

A small programmable constant charge pump current, known as a bleed current, can be applied to the charge pump to adjust the phase. Bleed current phase adjustment is used in integer mode. Bleed current can also be applied in fractional mode to optimize performance (see the [Charge Pump Bleed Current Optimization](#) section for more details). The LSB step size depends on the RFOUT frequency. PHASE_ADJ_POL determines the direction of the phase adjustment. When PHASE_ADJ_POL = 0, the phase value is decreased. When PHASE_ADJ_POL = 1, the phase value is increased.

Ensure the following bit fields are programmed accordingly to enable bleed current adjustment:

1. Set EN_BLEED = 1.
2. Set EN_PHASE_RESYNC = 1.
3. Set DEL_MODE = 0.
4. Use PHASE_ADJUSTMENT to determine the amount by which the phase is adjusted as follows:

$$\text{PHASE_ADJUSTMENT} = \left(\frac{\text{Phase in Degrees} \times 511}{250 \mu\text{A}} \right) \times I_{CP} \times \frac{f_{\text{PFD}}}{360 \times \text{RFOUT}} \quad (19)$$

The maximum adjustment time that can be achieved using the bleed current method is t_{RFOUT} .

The bleed current applied can be read back from DEL_CNT.

Σ - Δ Modulator Phase Adjustment

The Σ - Δ modulator can be used to adjust the phase of the RFOUT signal by applying an offset value. The device must be used in fractional mode to adjust the Σ - Δ modulator, which is the case whether a fractional or integer frequency is used. Note that the in-band figure of merit degrades by 2 dB as compared with using integer mode. In addition, the maximum f_{PFD} is then 250 MHz in fractional mode, as compared to 625 MHz in integer mode.

An advantage of using fractional mode for adjusting the phase is that the range is infinite, which means that each time a phase adjust is performed, the phase increments by the value stored in the PHASE_ADJUSTMENT bits (Register 0x033, Bits[7:0]) without any limit to the number of times this can be done.

Ensure that the following bit fields are programmed accordingly to enable Σ - Δ phase adjustment:

1. Set EN_PHASE_RESYNC = 1.
2. Set DEL_MODE = 1.
3. Use PHASE_ADJUSTMENT to determine the amount by which the phase is adjusted for the Σ - Δ modulator as follows:

$$\text{PHASE_ADJUSTMENT} = \left(\frac{\text{Phase in Degrees}}{360} \right) \times 2^{12} \quad (20)$$

PHASE_ADJ_POL selects the direction of adjustment. PHASE_ADJ_POL = 0 is positive and PHASE_ADJ_POL = 1 is negative. The PHASE_ADJUSTMENT value currently applied can be read back from the CUM_PHASE_ADJ bits (Register 0x061, Bits[7:0]). The maximum value is 8192 decimal. If this value is exceeded, the value overflows and wraps around.

When the required phase offsets are known prior to initializing the device, the PHASE_WORD bits can be used to program an initial phase offset using the same PHASE_ADJUSTMENT formula in this section.

Phase Adjust Pins

The ADF4383 has a 2-wire digital interface bus protocol that allows external control of the phase. This bus consists of DELSTR (Pin 29) and DELADJ (Pin 28). The signals are CMOS output signals with 1.8 V logic. This interface can be used in both bleed current and Σ - Δ mode phase adjustment. To enable the 2-wire interface, set EN_AUTO_ALIGN = 1.

DELSTR is an active high signal that is used to assert a phase adjustment. The amount by which the phase is adjusted is set in PHASE_ADJUSTMENT. The phase is adjusted on the falling edge of the signal.

DELADJ is an active high signal that controls the direction of the adjustment. If the signal is set to 0 while DELSTR is high, the RFOUT signal phase adjusts to earlier in time relative to the initial phase. If the signal is set to 1 while DELSTR is high, the RF output signal advances in time relative to the initial phase.

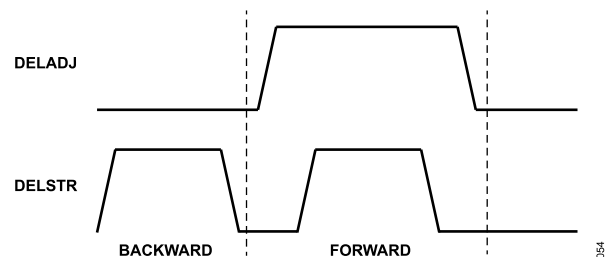

Figure 59. DELSTR and DELADJ Timing Diagrams

RF Output Buffer

The low noise, differential output buffer in [Figure 60](#) produces a differential output voltage. The output amplitude level and common-mode voltage is programmable with the RFOUT1_OPWR (Register 0x029, Bits[3:0]) and RFOUT2_OPWR (Register 0x029, Bits[7:4]) bits. Each output can be either AC- or DC-coupled and terminated with 100 Ω differentially. If a single-ended output is desired, each side of the output must be individually AC-coupled and terminated with 50 Ω . External inductors are required to achieve the highest output power. A 1.4 nH, 0402 sized, pull-up inductor is required to be connected to the RFOUTx 3.3 V supply (V3_RFOUTx) from the RFOUTx pins. Additionally, a series 100 nF capacitor must be connected to the RFOUTx pins as shown in [Figure 61](#).

THEORY OF OPERATION

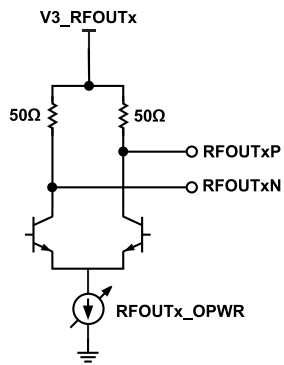

Figure 60. Simplified RF Output Buffer Schematic

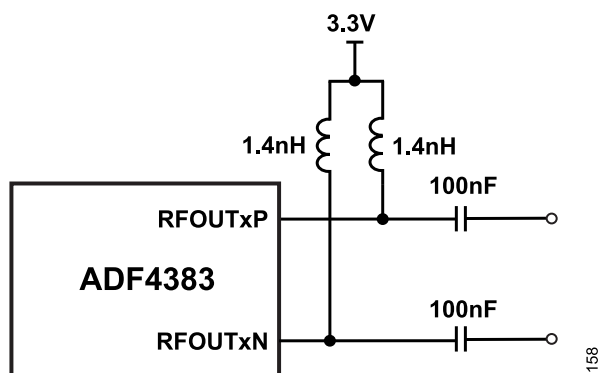

Figure 61. RFOUT Interface Schematic

Mute RF Output

The RFOUTxP and RFOUTxN pins can be muted by using the MUTE_RFOUTx bit fields (Register 0x40, Bits[5:3] and Bits[2:0], respectively).

Table 23. MUTE_RFOUTx, Bit 0 through Bit 7, Controls

MUTE_RFOUTx, Bits	Function
0	Normal operation
1	Mute low and disable the emitter follower driver
2	Mute high and disable the emitter follower driver
3	Mute low and leave the emitter follower driver on
4	Mute low and disable the emitter follower driver during calibration
5	Mute low and keep the emitter follower running during calibration
6	Mute low and disable the emitter follower driver when LOCKED = 0
7	Mute low and keep the emitter follower running when LOCKED = 0

It is recommended to use options that keep the emitter follower on to minimize current fluctuations.

APPLICATIONS INFORMATION

POWER-UP AND INITIALIZATION SEQUENCE

The following steps describe the recommended power-up and initialization sequence of the ADF4383:

1. Apply specified voltages to the V_{5V} , $V_{3.3V_1}$, and $V_{3.3V_2}$ power supply groups. The ADF4383 is in full power-down mode at this point and SPI programming is not possible.
2. Set the CE pin to a logic high. It is acceptable to connect the CE pin to the $V3_LDO$ pin via a pull-up resistor. Therefore, Step 1 and Step 2 are performed coincidentally.
3. After waiting $\geq 200 \mu\text{s}$ for all SPI register bits to settle to their power-on reset (POR) state, begin programming the SPI to configure the ADF4383 to a desired state. The following is the recommended SPI programming sequence:
 - a. Set the SDO_ACTIVE and CMOS_OV bits to a desired state for future readback operations.
 - b. Program all required register addresses. The ordering of programming does not matter except to ensure that Register 0x010 is the last register write. There are several required reserved register field settings provided in [Register Map](#) that are required for proper device operation.
4. The ADF4383 remains in power-down mode until the PD_ALL bit is programmed to 0. After PD_ALL is disabled, VTUNE is precharged in the loop filter to reduce VCO calibration time. The precharge time required before starting a VCO calibration depends on the largest value of capacitor in the loop filter. The wait time is: $750 \times C_{\text{MAX}}$, where C_{MAX} is the maximum value capacitor in the loop filter. The minimum precharge time is $50 \mu\text{s}$.
5. A write to Register 0x010 starts a VCO autocalibration. At this point, the ADF4383 is fully operational and new frequencies can be programmed as often as desired. The following steps are information for the PD_ALL bit and the CE pin.
6. Setting PD_ALL to 1 power down the ADF4383, retaining the latest programmed SPI settings and full SPI programming capability.
7. If only the state of PD_ALL was modified in Step 6, setting PD_ALL to 0 returns the ADF4383 to the frequency programmed in Step 5. After a $10 \mu\text{s}$ wait, all circuit blocks are completely powered up internally. This $10 \mu\text{s}$ wait does not include the frequency settling time associated with the loop filter bandwidth.
8. Toggling the CE pin level causes the ADF4383 to return to full power-down mode and return the SPI registers to the POR state (see Step 2 and Step 3).

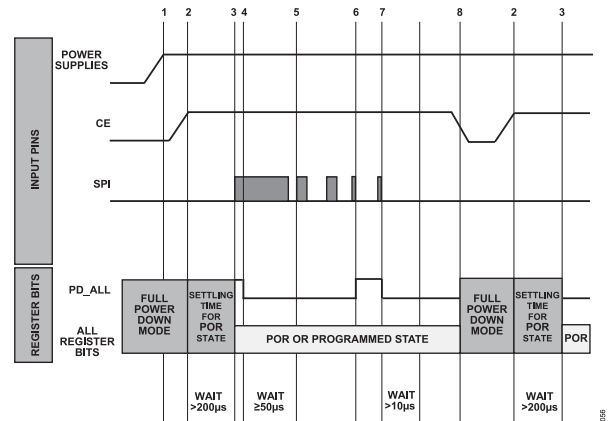

Figure 62. Power-Up and Initialization

Programming Procedure

There are two different methods to power up the ADF4383. The most commonly used method is provided in the [Standard Power-Up and Initialization Sequence, Automatic VCO Calibration](#) section is mandatory at the initial device power-up.

The method provided in the [Fast Power-Up and Initialization, Manually Programmed VCO Calibration Settings](#) section is an optional power-up procedure after the initial power-up.

APPLICATIONS INFORMATION

Standard Power-Up and Initialization Sequence, Automatic VCO Calibration

The following standard power-up and initialization sequence is the recommended procedure to power up and program the ADF4383:

1. Follow Step 1 through Step 5 in the [Power-Up and Initialization Sequence](#) section.
2. It is optional to monitor the status of the VCO calibration bits, ADC_BUSY and FSM_BUSY (Register 0x058, Bit 2 and Bit 1, respectively). A VCO calibration is completed when ADC_BUSY transitions from high to low followed by FSM_BUSY transitioning from high to low.
3. After the VCO calibration is complete, disable the VCO calibration clocks by setting EN_DRCLK = EN_DNCLK = EN_ADC_CLK = 0. Disabling the VCO calibration clocks reduces unwanted spurious content.
4. The PLL is locked when the lock detector sets the LKDET pin (Pin 27) and the LOCKED bit (Register 0x58, Bit 0) high.
5. When changing the frequency, take the following steps:
 - a. Program only the modified registers.
 - b. Write to Register 0x010 to start a new VCO autocalibration as the final step whether it is modified or not.

Fast Power-Up and Initialization, Manually Programmed VCO Calibration Settings

For fast frequency hopping applications, much shorter lock time is required. The ADF4383 can be manually programmed with predetermined calibration values to decrease overall lock time by bypassing VCO calibration. The calibration values are first obtained by performing an autocalibration and reading back the corresponding band, core, and bias values for a given frequency. These values can then be manually programmed to the ADF4383 on subsequent device initializations. The values of the readbacks vary with each device due to process variation.

The following steps outline the procedure to perform a manual VCO calibration after initialization:

1. Perform an autocalibration with the target frequency required.
2. Read back and record the VCO_CORE and VCO_BAND.
3. If VCO_CORE = 0, read the VCO bias value from VCO0_BIAS_RDBK. If VCO_CORE = 1, read the VCO bias value from VCO1_BIAS_RDBK. The value read is used as the M_VCO_BIAS value.
4. On subsequent power-up and initialization sequences, program the override (O_VCO_CORE, O_VCO_BAND, and O_VCO_BIAS) and manual VCO bits (M_VCO_CORE, M_VCO_BAND, and M_VCO_BIAS) as documented in [Table 24](#).
5. Program fractional N-divider bit field values as required. See [Output Frequency](#) for calculation.

6. Program N_INT value (Register 0x010) to program all manually calibrated values.
7. Repeat the sequence for each target frequency.

Note: When going from an integer to a fractional (or fractional to integer) RF output frequency, after the N_INT register has been written to, MUTE_NCLK must be set to 1 and then to 0.

Table 24. Manually Programmed VCO Calibration Settings

Bit Fields	Value	Description
O_VCO_DB	0x1	Manually calibrated values are double buffered by programming N_INT.
EN_AUTOCAL	0x0	Disables autocalibration.
EN_DRCLK	0x0	Disables DIV_RCLK to the digital block.
EN_DNCLK	0x0	Disables DIV_NCLK to the digital block.
EN_ADC_CLK	0x0	Disables the ADC clock.
O_VCO_CORE	0x1	Overrides the VCO core with value in M_VCO_CORE.
O_VCO_BAND	0x1	Overrides the VCO band with M_VCO_BAND.
O_VCO_BIAS	0x1	Overrides the VCO bias with M_VCO_BIAS.
M_VCO_CORE	Program with recorded values	Selects the VCO core when O_VCO_CORE = 1.
M_VCO_BAND	Program with recorded values	Selects the band within the core when O_VCO_BAND = 1.
M_VCO_BIAS	Program with recorded values	Selects the bias value used when O_VCO_BIAS = 1.
N_INT	N-divider integer word	Programs the double buffered manually calibrated values when written.
MUTE_NCLK	0x1	Mutes the clock signal from the N-divider block to the PFD. MUTE_NCLK must only be set to 1 and then to 0 when going from an integer to a fractional frequency or fractional to integer frequency.

APPLICATIONS INFORMATION

Fast Calibration

The fast calibration feature enables a VCO calibration time of $<2 \mu\text{s}$ for each output frequency change, by storing 32 discrete VCO core, band, and bias values across the octave range of the ADF4383. Fast calibration can be initiated during device initialization. When fast calibration is started, autocalibration is performed at 32 output frequencies across the octave output frequency range of the ADF4383. An on-chip look-up table in the device register map is used to store the corresponding VCO core, band, and bias value for each output frequency.

After initialization, subsequent output frequency changes utilize the previously stored look-up table to determine the optimal VCO calibration values by interpolation. Fast calibration is a more efficient alternative solution to manually programming VCO calibration settings, which requires an external microcontroller with memory storage. It also reduces the number of SPI writes required at each output frequency compared to manually writing. This feature is particularly useful in applications requiring many frequency hops.

LOOP FILTER DESIGN

A stable loop filter design requires care in selecting the loop filter components of the ADF4383. It is recommended to download and install ADIsimPLL for loop filter design and simulation. ADIsimPLL has an integrated tutorial for first time users and a help manual for more complex topics. There are also several ADIsimPLL training videos available on the ADIsimPLL web page. After a loop filter is designed and simulated, it is recommended to verify the new loop filter using the ADF4383 evaluation hardware. A full loop filter design tutorial is beyond the scope of this data sheet. However, some best practices are shown in the following list. ADIsimPLL aids in defining and simulating these parameters. Any significant change to these items requires a new loop filter design.

A stable loop filter must meet the following criteria:

- ▶ Loop filter phase margin $> 45^\circ$
- ▶ Loop filter bandwidth $< f_{\text{PFD}} \div 10$

The desired loop filter bandwidth is determined by the following features of the ADF4383:

- ▶ I_{CP}
- ▶ K_{VCO}
- ▶ PFD frequency
- ▶ Reference input phase noise (see the [Reference Phase Noise](#) section)
- ▶ Trade-off between minimizing jitter or settling time

The VTUNE pin has an internal 54 pF capacitor to GND that must be included in the loop filter design. ADIsimPLL takes this internal capacitance into account automatically.

Another consideration when selecting the loop filter components is the largest value capacitor in the loop filter design because this will

directly affect the minimum VTUNE precharge time before a VCO calibration. The minimum precharge time is calculated as follows:

$$t_{\text{PRECHARGE}} = \frac{C \times V}{I} \quad (21)$$

where:

I is the VCO calibration generator current (6 mA).

C is the largest loop filter capacitance.

V is the nominal charge pump voltage.

For example, using a capacitance value of 10 nF and charge pump voltage of 3.6 V results in the following:

$$t_{\text{PRECHARGE}} = \frac{10 \text{ nF} \times 3.6 \text{ V}}{6 \text{ mA}} = 6 \mu\text{s}$$

Refer to the [VCO Calibration](#) section for programming the precharge time dependent bit fields.

REFERENCE SOURCE CONSIDERATIONS

Reference Input Network

The reference input buffer of the ADF4383 shown in [Figure 46](#) provides a flexible interface to either differential or single-ended frequency sources. [Figure 63](#) to [Figure 68](#) show the recommended interfaces for different reference signal types. All characteristic impedance (Z_0) signal traces are 50 Ω transmission lines.

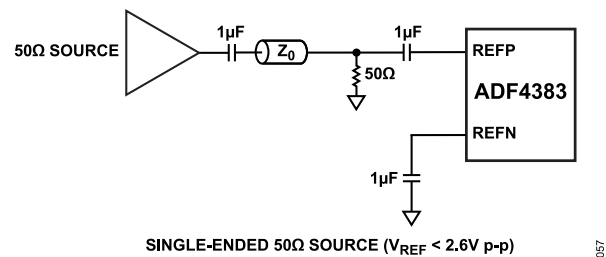

Figure 63. Single-Ended 50 Ω Source ($V_{\text{REF}} < 2.6 \text{ V p-p}$)

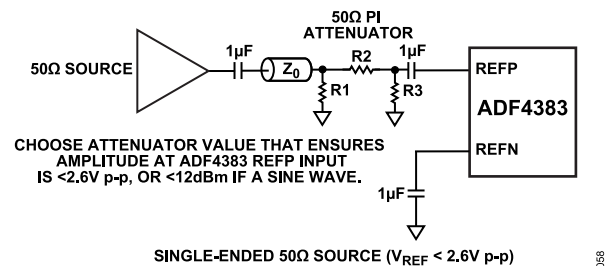

Figure 64. Single-Ended 50 Ω Source ($V_{\text{REF}} < 2.6 \text{ V p-p}$)

APPLICATIONS INFORMATION

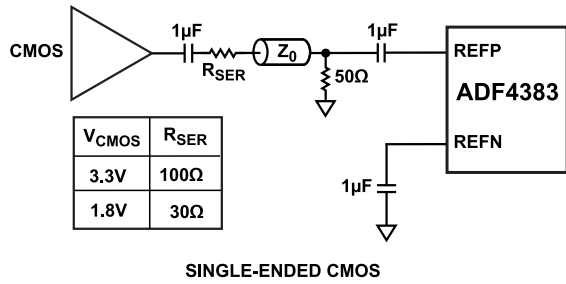

Figure 65. Single-Ended CMOS (R_{SER} Is the Series Resistance.)

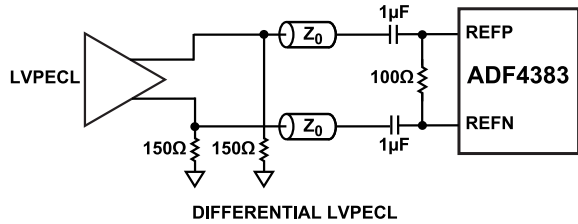

Figure 66. Differential, Low Voltage, Positive Emitter-Coupled Logic (LVPECL)

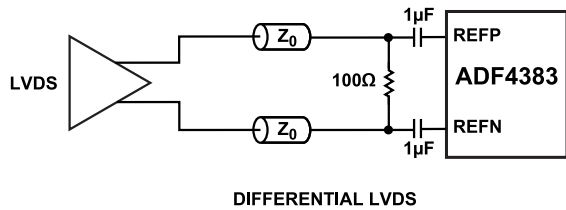

Figure 67. Differential LVDS

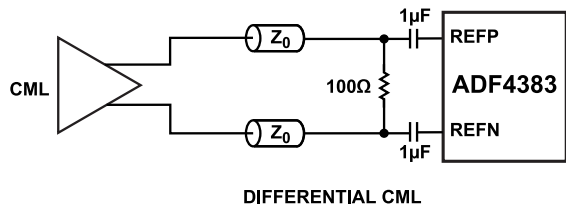

Figure 68. Differential CML

Reference Phase Noise

The ADF4383 achieves an in-band normalized phase noise floor of L_{NORM} = -239 dBc/Hz in integer mode and L_{NORM} = -237 dBc/Hz in fractional mode.

To calculate the equivalent input phase noise floor (L_{IN}) use the following formula:

$$L_{IN} = L_{NORM} + 10 \times \log_{10}(f_{REF}) \tag{22}$$

For example, a 100 MHz reference input frequency gives an L_{IN} of -157 dBc/Hz in fractional mode. The phase noise of the reference frequency source must be at least 6 dB less than L_{IN} to avoid impacting and increasing the overall system phase noise.

To maintain typical L_{NORM} performance, Table 7 provides criteria for selecting the optimal REF_SEL (Register 0x030, Bit 5) setting based on the input reference signal type and amplitude.

SYNC INPUT NETWORK

The SYNC input pins may be programmed for CML/LVPECL or LVDS interfaces using the SYNC_SEL bit to support a range of input SYNC signal levels. Figure 69 to Figure 72 show recommended input networks to SYNC input pins.

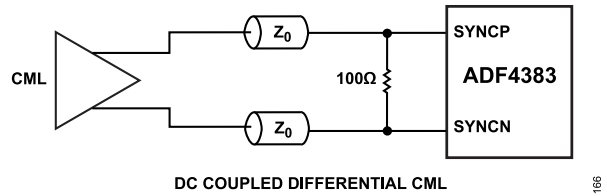

Figure 69. DC-Coupled Differential CML (Set SYNC_SEL = 0)

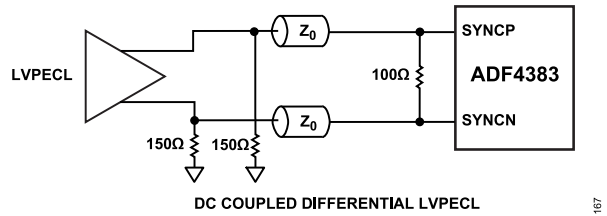

Figure 70. DC-Coupled Differential LVPECL (Set SYNC_SEL = 0)

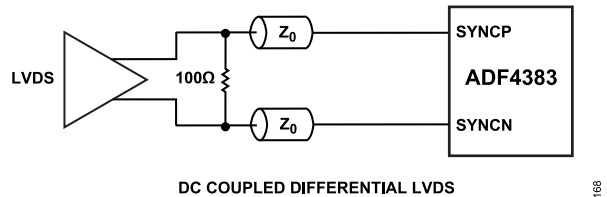

Figure 71. DC-Coupled Differential LVDS (Set SYNC_SEL = 1)

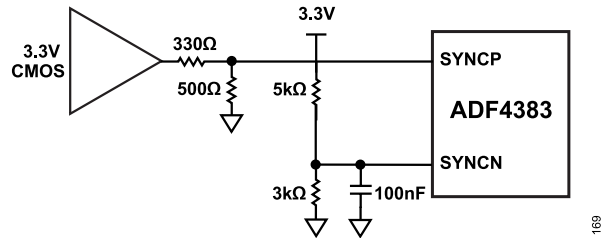

Figure 72. DC-Coupled 3.3 V Single-Ended Logic to LVDS Input (Set SYNC_SEL = 1)

OUTPUT PHASE NOISE CHARACTERISTICS

In-Band Output Phase Noise

Use the following equations to calculate the in-band phase noise floor (L_{OUT}) produced at f_{OUT}:

APPLICATIONS INFORMATION

$$L_{OUT} = L_{NORM} + 10 \times \log_{10}(f_{PFD}) + 20 \times \log_{10}\left(\frac{f_{OUT}}{f_{PFD}}\right) \quad (23)$$

or

$$L_{OUT} = L_{NORM} + 10 \times \log_{10}(f_{PFD}) + 20 \times \log_{10}\left(\frac{N}{O}\right) \quad (24)$$

Output Phase Noise Due to 1/f Noise

In-band phase noise at low offset frequencies can be influenced by the 1/f noise of the ADF4383 depending on the f_{PFD} . Use the normalized in-band 1/f noise ($L_{1/f}$) of -287 dBc/Hz to approximate the output 1/f phase noise at a given frequency offset (f_{OFFSET}) as follows:

$$L_{OUT(1/f)} = L_{1/f} + 20 \times \log_{10}(f_{OUT}) - 10 \times \log_{10}(f_{OFFSET}) \quad (25)$$

Unlike the in-band noise floor (L_{OUT}), the 1/f noise ($L_{OUT(1/f)}$) does not change with f_{PFD} and is not constant over offset frequency. For an example of in-band phase noise for f_{PFD} equal to 100 MHz and 500 MHz for integer mode, see [Figure 73](#). The total phase noise is the summation of L_{OUT} and $L_{OUT(1/f)}$ calculated by the following formula:

$$L_{OUT(TOTAL)} = 10 \times \log_{10}\left(10^{L_{OUT}/10} + 10^{L_{OUT(1/f)}/10}\right) \quad (26)$$

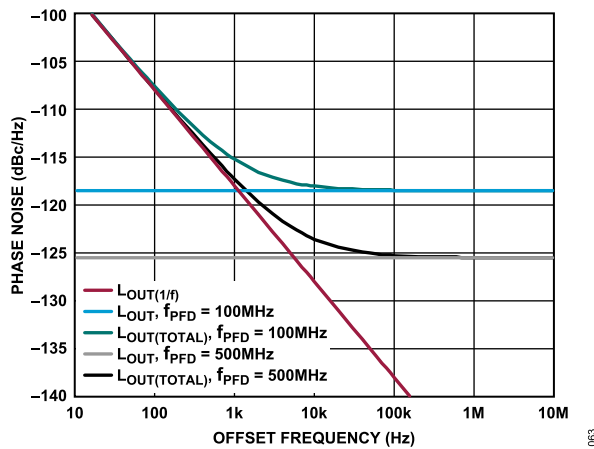

Figure 73. Theoretical In-Band Phase Noise, $f_{OUT} = 10$ GHz

OUTPUT PHASE SYNCHRONIZATION OF MULTIPLE ADF4383 DEVICES

To synchronize multiple ADF4383 devices, use one of the following two methods:

- ▶ EZSync™ method, which uses SPI register writes for synchronization

- ▶ Timed synchronization method, which uses the SYNCx pin on the ADF4383 for synchronization

EZSync Method

The EZSync synchronization method allows synchronization of the output phases of multiple devices without the need for a separate synchronization signal, which has the advantage of reducing PCB layout complexity in systems using multiple ADF4383 devices.

EZSync relies on sending a synchronization request through the SPI by setting `SW_SYNC = 1` instead of the SYNC pin. The problem with sending the request over the SPI is that the SPI is a slow protocol and does not have any time accuracy. Sending the request in the same reference period is also another challenge and not possible for the large number of ADF4383 devices used. With EZSync, these problems are solved by starting and stopping the DC-coupled reference signal glitchlessly, which removes the setup and hold time concerns with sending a request through the SPI. The reference signals must stop and start accurately and without any glitch or without any runt pulse. The clock generation and distribution devices from Analog Devices, such as the [HMC7044B](#), are recommended as these devices are compatible with EZSync.

The following steps outline the procedure to perform an EZSync with two ADF4383 devices (assumes the hardware is set up as per [Figure 74](#)):

1. Set up the HMC7044B for EZSync configuration as follows:
 - a. Set the channel that is used as a reference to the ADF4383 to dynamic mode. For example, for Channel 0, set Register 0x00C8 to 0xFF.
 - b. Set the output driver mode of the channel to LVPECL or CML and set the mute select of the channel to 0. For example, set Register 0x00D0 = 0x89.
 - c. Set the pulse generator mode selection to continuous mode by setting Register 0x005A to 0x07.
 - d. Send a reseed request to start the references by setting the reseed request to 1 and then 0 by setting Register 0x001 to 0x80 then setting to 0x00.
2. Set up each ADF4383 as follows:
 - a. Initialize the ADF4383 with the default initialization settings.
 - b. Set `TIMED_SYNC = 0`.
 - c. Set `EN_REF_RST = 1`.
 - d. Set `EN_PHASE_RESYNC = 1`.
 - e. Set `SYNC_SEL = 1`.
3. Verify that both ADF4383 devices are locked.
4. Synchronize both ADF4383 RFOUT signals:
 - a. On an oscilloscope, first verify that both ADF4383 parts are not synchronized.
 - b. Set `SW_SYNC = 1` on each ADF4383.
 - c. Set Pulse Generator Mode Selection to 0 to stop the reference on the HMC7044B (set Register 0x005A to 0x00).

APPLICATIONS INFORMATION

- d. Set Pulse Generator Mode Selection to 7 on the HMC7044B (set Register 0x005A to 0x07).
 - e. Send a pulse request by setting Register 0x0001 to 0x04 then 0x0 to restart the reference.
 - f. Set SW_SYNC = 0 on each ADF4383.
5. On the oscilloscope, verify that the outputs from both ADF4383 devices are synchronized (aside from cable mismatch).

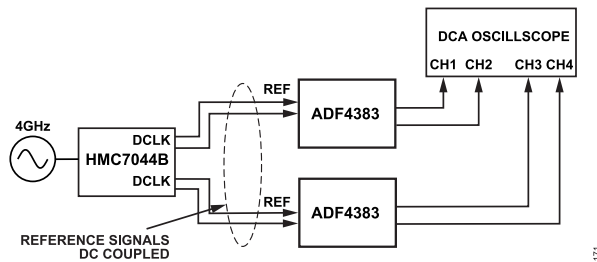

Figure 74. EZSync Configuration

Timed Synchronization Method

The timed synchronization method uses an external synchronization signal to synchronize multiple ADF4383 devices, which is the more traditional method for synchronization of devices. This method requires an additional external signal from the clock distribution device to provide the synchronization signal. Each synchronization signal must be matched for accurate output phase matching. A rising edge of the synchronization pulse on the SYNC pin of the ADF4383 triggers the start of the synchronization process, which then puts the device into a reset state. On the falling edge of the synchronization pulse, the RFOUT signal phase on each ADF4383 is then aligned to a known phase relative to the reference phase.

The following steps outline the procedure to perform a timed synchronization with two ADF4383 devices in the configuration shown in Figure 75:

1. Set up the HMC7044B as follows:
 - a. Set the channels used as a reference to the ADF4383 to asynchronous mode (for example, set Register 0x00C8 to 0xF3 for Channel 0).
 - b. Set the divider ratio of the reference channels to 16 for a reference frequency of 250 MHz (for example, set Register 0x00C9 for Channel 0).
 - c. Set the channels used as a SYNC signal to the ADF4383 to dynamic mode (for example, set Register 0x00D2 to 0xFF).
 - d. Set the divider ratio of the SYNC channels to 8.
 - e. Set the SYSREF timer (Register 0x005B and Register 0x005C) value of the HMC7044B the same as the divider value of the SYNC channels.
 - f. Set the pulse mode selection to pulse (set Register 0x005A to 0x01).

- g. Send a reseed request to start the references by setting the reseed request to 1 and then 0 by setting Register 0x001 to 0x80 then setting to 0x00.
2. Set up the ADF4383 as follows:
- a. Set TIMED_SYNC (Register 0x01E, Bit 5) = 1.
 - b. Set EN_REF_RST (Register 0x01E, Bit 6) = 1.
 - c. Set EN_PHASE_RESYNC (Register 0x01E, Bit 7) = 1.
 - d. Set SYNC_SEL (Register 0x053, Bit 5) = 0.
 - e. Set R_DIV (Register 0x020, Bits[5:0]) = 4.
 - f. Set EN_DRCLK (Register 0x02D, Bit 6) = 1.
 - g. Verify that the ADF4383 devices are locked.
3. Synchronize both ADF4383 devices as follows:
- a. Verify that both ADF4383 outputs are not synchronized.
 - b. Send a pulse generator request to the HMC7044B by toggling Register 0x001 data from 0x04 to 0x00.
 - c. Verify that both outputs on both ADF4383 devices is now phase synchronized.

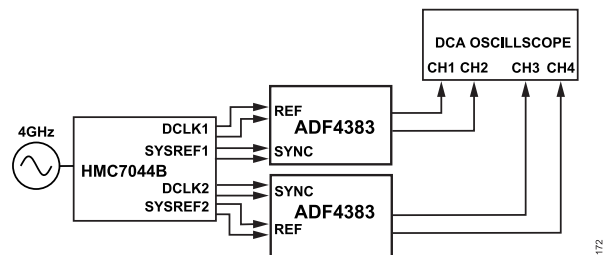

Figure 75. Timed Synchronization Configuration

APPLICATIONS INFORMATION

PHASE SYNCHRONIZATION SETTINGS

To optimize phase noise and spurious performance on the ADF4383, there are a number of bit fields that must be program-

med based on the f_{PFD} used. Table 25 shows the optimal settings for phase synchronization.

Table 25. Phase Synchronization Settings

PFD Frequency	RDIV = 3, 6, 12, 14, 15, 24, 26 to 31, 46, 48 to 63			RDIV = 1, 2, 4, 5, 7 to 11, 13, 16 to 23, 25, 32 to 45, 47		
	REF_CK_FALL	REF_DC_SEL	xx_DEL ¹	REF_CK_FALL	REF_DC_SEL	xx_DEL ¹
$f_{\text{PFD}} \geq 225$ MHz	0	0	3	0	0	3
$200 \text{ MHz} \leq f_{\text{PFD}} < 225$ MHz	0	0	4	0	0	4
$148 \text{ MHz} \leq f_{\text{PFD}} < 200$ MHz	1	3	1	1	3	0
$130 \text{ MHz} \leq f_{\text{PFD}} < 148$ MHz	1	3	3	1	3	1
$85 \text{ MHz} \leq f_{\text{PFD}} < 130$ MHz	1	3	4	1	3	1
$f_{\text{PFD}} < 85$ MHz	1	2	0	1	2	1

¹ xx_DEL denotes SYNC_DEL, DNCLK_DEL, and DRCLK_DEL.

APPLICATIONS INFORMATION

PHASE RESYNCHRONIZATION

Phase resynchronization is a feature that allows a consistent phase on the RFOUT signal with respect to the input reference at each output frequency, which is useful in applications requiring synchronization of multiple ADF4383 devices. After multiple devices are synchronized, any additional resynchronizing (for example, after a frequency change) is not needed. When phase resynchronization is used, the maximum value for MOD2WORDMAX is $= 2^{17} - 1 = 131071$. Refer to [Output Frequency](#) section for MOD2WORDMAX calculation.

The following sequence is the phase resynchronization method procedure:

1. Power up and initialize the ADF4383 devices.
2. Program all ADF4383 devices to the same frequency.
3. Perform an initial synchronization (see the [Timed Synchronization Method](#) section or the [EZSync Method](#) section for additional information).
4. Enable phase resynchronization mode by taking the following steps:
 - a. Set DEL_MODE (Register 0x032, Bit 5) = 1.
 - b. Set EN_PHASE_RESYNC (Register 0x01E, Bit 7) = 1.
 - c. Set EN_REF_RST (Register 0x01E, Bit 6) = 0.
 - d. Set EN_DRCLK (Register 0x02D, Bit 6) = 1.
 - e. Program the t_{RESYNC} default to 100 μ s by

$$t_{RESYNC} = \frac{RESYNC_WAIT}{f_{PFD}} \quad (27)$$

for $f_{PFD} = 250$ MHz and $t_{RESYNC} = 25,000$.

Note that when using fast power-up and initialization, manually programmed VCO calibration settings (see the [Fast Power-Up and Initialization, Manually Programmed VCO Calibration Settings](#) section), MUTE_NCLK must be set to 1 after going from integer to fractional RF output frequencies (or vice versa). In this case, phase resynchronization is not maintained each time MUTE_NCLK is set to 1 after a frequency change.

REGISTER MAP

Table 26. ADF4383 Register Summary

Reg	Name	Bits	Bit 7	Bit 6	Bit 5	Bit 4	Bit 3	Bit 2	Bit 1	Bit 0	Reset	RW	
0x000	REG0000	[7:0]	SOFT_RES ET_R	LSB_FIRST _R	ADDRESS_ ASCENSIO N_R	SDO_ACTIV E_R	SDO_ACTIV E	ADDRESS_ ASCENSIO N	LSB_FIRST	SOFT_RES ET	0x00	R/W	
0x001	REG0001	[7:0]	SINGLE_IN STRUCTION	0	MAIN_READ BACK_CON TROL	0	RESERVED	0	0	RESERVED	0x00	R/W	
0x003	REG0003	[7:0]	RESERVED				CHIP_TYPE				0x00	R	
0x004	REG0004	[7:0]	PRODUCT_ID[7:0]								0x00	R	
0x005	REG0005	[7:0]	PRODUCT_ID[15:8]								0x00	R	
0x00A	REG000A	[7:0]	SCRATCHPAD								0x00	R/W	
0x00C	REG000C	[7:0]	VENDOR_ID[7:0]								0x56	R	
0x00D	REG000D	[7:0]	VENDOR_ID[15:8]								0x04	R	
0x010	REG0010	[7:0]	N_INT[7:0]								0x80	R/W	
0x011	REG0011	[7:0]	RFOUT_DIV			INV_RFOUT	N_INT[11:8]				0x00	R/W	
0x012	REG0012	[7:0]	FRAC1WORD[7:0]								0x00	R/W	
0x013	REG0013	[7:0]	FRAC1WORD[15:8]								0x00	R/W	
0x014	REG0014	[7:0]	FRAC1WORD[23:16]								0x00	R/W	
0x015	REG0015	[7:0]	M_VCO_BA ND[0]	M_VCO_CO RE	RESERVED			INT_MODE	PFD_POL	FRAC1WOR D[24]	0x00	R/W	
0x016	REG0016	[7:0]	M_VCO_BAND[8:1]								0x00	R/W	
0x017	REG0017	[7:0]	FRAC2WORD[7:0]								0x00	R/W	
0x018	REG0018	[7:0]	FRAC2WORD[15:8]								0x00	R/W	
0x019	REG0019	[7:0]	FRAC2WORD[23:16]								0x00	R/W	
0x01A	REG001A	[7:0]	MOD2WORD[7:0]								0x00	R/W	
0x01B	REG001B	[7:0]	MOD2WORD[15:8]								0x00	R/W	
0x01C	REG001C	[7:0]	MOD2WORD[23:16]								0x00	R/W	
0x01D	REG001D	[7:0]	BLEED_I[7:0]								0x00	R/W	
0x01E	REG001E	[7:0]	EN_PHASE RESYNC	EN_REF_R ST	TIMED_SYN C	BLEED_I[12:8]				0x00	R/W		
0x01F	REG001F	[7:0]	SW_SYNC	RESERVED	BLEED_POL	EN_BLEED	CP_I				0x00	R/W	
0x020	REG0020	[7:0]	EN_AUTO CAL	EN_RDBLR	R_DIV							0x01	R/W
0x021	REG0021	[7:0]	PHASE_WORD[7:0]								0x00	R/W	
0x022	REG0022	[7:0]	PHASE_WORD[15:8]								0x00	R/W	
0x023	REG0023	[7:0]	PHASE_WORD[23:16]								0x00	R/W	
0x024	REG0024	[7:0]	REF_CK_FA LL	REF_DC_SEL	DCLK_DIV_ SEL	DNCLK_DIV1	DCLK_DIV1			0x00	R/W		
0x025	REG0025	[7:0]	RESYNC_WAIT[7:0]								0x00	R/W	
0x026	REG0026	[7:0]	RESYNC_WAIT[15:8]								0x00	R/W	
0x027	REG0027	[7:0]	0xF				0x0				0x00	R/W	
0x028	REG0028	[7:0]	PHASE_RE SYNC_RB_ SEL	LSB_P1	VAR_MOD_ EN	DITHER1_SCALE			EN_DITHER 2	EN_DITHER 1	0x00	R/W	
0x029	REG0029	[7:0]	RFOUT2_OPWR				RFOUT1_OPWR				0x00	R/W	
0x02A	REG002A	[7:0]	0	0	1	PD_SYNC	0	PD_RDET	PD_ADC	0	0x04	R/W	
0x02B	REG002B	[7:0]	PD_ALL	PD_RDIV	PD_NDIV	PD_VCO	PD_LD	PD_PFD CP	PD_RFOUT 1	PD_RFOUT 2	0x83	R/W	
0x02C	REG002C	[7:0]	LDWIN_PW				LD_COUNT				0x00	R/W	
0x02D	REG002D	[7:0]	EN_DNCLK	EN_DRCLK	EN_LOL	EN_LDWIN	0	RST_LD	0	1	0x00	R/W	

REGISTER MAP

Table 26. ADF4383 Register Summary (Continued)

Reg	Name	Bits	Bit 7	Bit 6	Bit 5	Bit 4	Bit 3	Bit 2	Bit 1	Bit 0	Reset	RW		
0x02E	REG002E	[7:0]	MUXOUT				RESERVED	EN_CPTES T	CP_DOWN	CP_UP	0x00	R/W		
0x02F	REG002F	[7:0]	BST_REF	FILT_REF	RDBLR_DC						0x00	R/W		
0x030	REG0030	[7:0]	MUTE_NCL K	RESERVED	REF_SEL	INV_RDBLR	RDBLR_DEL_SEL				0x00	R/W		
0x031	REG0031	[7:0]	SYNC_DEL			RST_SYS	EN_ADC_C LK	RESERVED	1	DCLK_MOD E	0x00	R/W		
0x032	REG0032	[7:0]	RESERVED	1	DEL_MODE	EN_AUTO_ ALIGN	PHASE_ADJ _POL	EFM3_MODE			0x00	R/W		
0x033	REG0033	[7:0]	PHASE_ADJUSTMENT									0x00	R/W	
0x034	REG0034	[7:0]	PHASE_ADJ	DRCLK_DEL			DNCLK_DEL			RST_CNTR	0x00	R/W		
0x035	REG0035	[7:0]	RESERVED			M_VCO_BIAS						0x00	R/W	
0x036	REG0036	[7:0]	RFOUTDIV _DB	DCLK_DIV_ DB	RESERVED				EN_LUT_GE N	EN_LUT_CA L	0x00	R/W		
0x037	REG0037	[7:0]	CAL_COUNT_TO									0x00	R/W	
0x038	REG0038	[7:0]	CAL_VTUNE_TO[7:0]									0x00	R/W	
0x039	REG0039	[7:0]	O_VCO_DB	CAL_VTUNE_TO[14:8]								0x00	R/W	
0x03A	REG003A	[7:0]	CAL_VCO_TO[7:0]									0x00	R/W	
0x03B	REG003B	[7:0]	DEL_CTRL_ DB	CAL_VCO_TO[14:8]								0x00	R/W	
0x03C	REG003C	[7:0]	0x0									0x00	R/W	
0x03D	REG003D	[7:0]	RESERVED	0	CMOS_OV	0	0				0x00	R/W		
0x03E	REG003E	[7:0]	ADC_CLK_DIV									0x00	R/W	
0x03F	REG003F	[7:0]	1	0	0	0	0	0	EN_ADC	0	0x00	R/W		
0x040	REG0040	[7:0]	0	0	MUTE_RFOUT2			MUTE_RFOUT1			0x00	R/W		
0x041	REG0041	[7:0]	0			0	0	0	0	0	0x00	R/W		
0x042	REG0042	[7:0]	0x1									0x00	R/W	
0x043	REG0043	[7:0]	0xB8									0x00	R/W	
0x044	REG0044	[7:0]	VCAL_ZER O	0x2E								0x00	R/W	
0x045	REG0045	[7:0]	RESERVED	0x52								0x00	R/W	
0x04B	REG004B	[7:0]	0x5D									0x00	R/W	
0x04C	REG004C	[7:0]	RESERVED			0x2B						0x00	R/W	
0x04D	REG004D	[7:0]	RESERVED						O_VCO_BIA S	O_VCO_BA ND	O_VCO_CO RE	0x00	R/W	
0x04F	REG004F	[7:0]	LUT_SCALE									0x00	R/W	
0x053	REG0053	[7:0]	RESERVED	PD_SYNC_ MON	SYNC_SEL	RST_SYNC_ _MON	0x5				0x00	R/W		
0x054	REG0054	[7:0]	RESERVED									ADC_ST_C NV	0x00	R/W
0x055	REG0055	[7:0]	COUNTER_READBACK[7:0]									0x00	R	
0x056	REG0056	[7:0]	COUNTER_READBACK[15:8]									0x00	R	
0x057	REG0057	[7:0]	COUNTER_READBACK[23:16]									0x00	R	
0x058	REG0058	[7:0]	LUT_BUSY	SYNC_OK	DEL_STR	DEL_ADJ	REF_OK	ADC_BUSY	FSM_BUSY	LOCKED	0x00	R		
0x059	REG0059	[7:0]	RESERVED			VCO0_BIAS_RDBK						0x00	R	
0x05A	REG005A	[7:0]	RESERVED			VCO1_BIAS_RDBK						0x00	R	
0x05B	REG005B	[7:0]	CHIP_TEMP[7:0]									0x00	R	
0x05C	REG005C	[7:0]	RESERVED									CHIP_TEM P[8]	0x00	R

REGISTER MAP

Table 26. ADF4383 Register Summary (Continued)

Reg	Name	Bits	Bit 7	Bit 6	Bit 5	Bit 4	Bit 3	Bit 2	Bit 1	Bit 0	Reset	RW	
0x05E	REG005E	[7:0]	VCO_BAND[7:0]								0x00	R	
0x05F	REG005F	[7:0]	RESERVED						VCO_CORE	VCO_BAND[8]	0x00	R	
0x061	REG0061	[7:0]	CUM_PHASE_ADJ[7:0]								0x00	R	
0x062	REG0062	[7:0]	CUM_PHASE_ADJ[15:8]								0x00	R	
0x063	REG0063	[7:0]	RESERVED							CUM_PHASE_ADJ[16]	0x00	R	
0x064	REG0064	[7:0]	DEL_CNT[7:0]								0x00	R	
0x065	REG0065	[7:0]	DEL_CNT[15:8]								0x00	R	
0x066	REG0066	[7:0]	FIRST_PASS_VCO_BAND								0x00	R	
0x067	REG0067	[7:0]	VERSION								0x00	R	
0x100	REG0100	[7:0]	RESERVED						0x3		0x00	R/W	
0x101	REG0101	[7:0]	RESERVED						0x7		0x00	R/W	
0x102	REG0102	[7:0]	RESERVED						0x3F		0x00	R/W	
0x103	REG0103	[7:0]	RESERVED						0x3F		0x00	R/W	
0x104	REG0104	[7:0]	RESERVED						0x3F		0x00	R/W	
0x105	REG0105	[7:0]	RESERVED						0x3F		0x00	R/W	
0x106	REG0106	[7:0]	RESERVED						0x7		0x00	R/W	
0x107	REG0107	[7:0]	RESERVED						0x7		0x00	R/W	
0x108	REG0108	[7:0]	RESERVED						0x7		0x00	R/W	
0x109	REG0109	[7:0]	RESERVED						0x3F		0x00	R/W	
0x10A	REG010A	[7:0]	RESERVED						0x3F		0x00	R/W	
0x10B	REG010B	[7:0]	RESERVED						0x3F		0x00	R/W	
0x10C	REG010C	[7:0]	RESERVED						0x3F		0x00	R/W	
0x10D	REG010D	[7:0]	RESERVED						0x3F		0x00	R/W	
0x10E	REG010E	[7:0]	RESERVED						0x3F		0x00	R/W	
0x10F	REG010F	[7:0]	RESERVED						0x3F		0x00	R/W	
0x110	REG0110	[7:0]	RESERVED						0x3F		0x00	R/W	
0x111	REG0111	[7:0]	RESERVED						0x3F		0x00	R/W	
0x200	REG0200	[7:0]	RESERVED	LUT_WR_ADDR							O_VCO_LUT	0x00	R/W
0x201	REG0201	[7:0]	M_LUT_BAND[7:0]								0x00	R/W	
0x202	REG0202	[7:0]	M_LUT_N[5:0]					M_LUT_CORE	M_LUT_BAND[8]	0x00	R/W		
0x203	REG0203	[7:0]	RESERVED	M_LUT_N[11:6]							0x00	R/W	
0x204	REG0204	[7:0]	LUT_BAND_0[7:0]								0x00	R	
0x205	REG0205	[7:0]	RESERVED						LUT_CORE[0]	LUT_BAND_0[8]	0x00	R	
0x206	REG0206	[7:0]	LUT_BAND_1[7:0]								0x00	R	
0x207	REG0207	[7:0]	RESERVED						LUT_CORE[1]	LUT_BAND_1[8]	0x00	R	
0x208	REG0208	[7:0]	LUT_BAND_2[7:0]								0x00	R	
0x209	REG0209	[7:0]	RESERVED						LUT_CORE[2]	LUT_BAND_2[8]	0x00	R	
0x20A	REG020A	[7:0]	LUT_BAND_3[7:0]								0x00	R	
0x20B	REG020B	[7:0]	RESERVED						LUT_CORE[3]	LUT_BAND_3[8]	0x00	R	
0x20C	REG020C	[7:0]	LUT_BAND_4[7:0]								0x00	R	

REGISTER MAP

Table 26. ADF4383 Register Summary (Continued)

Reg	Name	Bits	Bit 7	Bit 6	Bit 5	Bit 4	Bit 3	Bit 2	Bit 1	Bit 0	Reset	RW
0x20D	REG020D	[7:0]			RESERVED				LUT_CORE[4]	LUT_BAND_4[8]	0x00	R
0x20E	REG020E	[7:0]				LUT_BAND_5[7:0]					0x00	R
0x20F	REG020F	[7:0]			RESERVED				LUT_CORE[5]	LUT_BAND_5[8]	0x00	R
0x210	REG0210	[7:0]				LUT_BAND_6[7:0]					0x00	R
0x211	REG0211	[7:0]			RESERVED				LUT_CORE[6]	LUT_BAND_6[8]	0x00	R
0x212	REG0212	[7:0]				LUT_BAND_7[7:0]					0x00	R
0x213	REG0213	[7:0]			RESERVED				LUT_CORE[7]	LUT_BAND_7[8]	0x00	R
0x214	REG0214	[7:0]				LUT_BAND_8[7:0]					0x00	R
0x215	REG0215	[7:0]			RESERVED				LUT_CORE[8]	LUT_BAND_8[8]	0x00	R
0x216	REG0216	[7:0]				LUT_BAND_9[7:0]					0x00	R
0x217	REG0217	[7:0]			RESERVED				LUT_CORE[9]	LUT_BAND_9[8]	0x00	R
0x218	REG0218	[7:0]				LUT_BAND_10[7:0]					0x00	R
0x219	REG0219	[7:0]			RESERVED				LUT_CORE[10]	LUT_BAND_10[8]	0x00	R
0x21A	REG021A	[7:0]				LUT_BAND_11[7:0]					0x00	R
0x21B	REG021B	[7:0]			RESERVED				LUT_CORE[11]	LUT_BAND_11[8]	0x00	R
0x21C	REG021C	[7:0]				LUT_BAND_12[7:0]					0x00	R
0x21D	REG021D	[7:0]			RESERVED				LUT_CORE[12]	LUT_BAND_12[8]	0x00	R
0x21E	REG021E	[7:0]				LUT_BAND_13[7:0]					0x00	R
0x21F	REG021F	[7:0]			RESERVED				LUT_CORE[13]	LUT_BAND_13[8]	0x00	R
0x220	REG0220	[7:0]				LUT_BAND_14[7:0]					0x00	R
0x221	REG0221	[7:0]			RESERVED				LUT_CORE[14]	LUT_BAND_14[8]	0x00	R
0x222	REG0222	[7:0]				LUT_BAND_15[7:0]					0x00	R
0x223	REG0223	[7:0]			RESERVED				LUT_CORE[15]	LUT_BAND_15[8]	0x00	R
0x224	REG0224	[7:0]				LUT_BAND_16[7:0]					0x00	R
0x225	REG0225	[7:0]			RESERVED				LUT_CORE[16]	LUT_BAND_16[8]	0x00	R
0x226	REG0226	[7:0]				LUT_BAND_17[7:0]					0x00	R
0x227	REG0227	[7:0]			RESERVED				LUT_CORE[17]	LUT_BAND_17[8]	0x00	R
0x228	REG0228	[7:0]				LUT_BAND_18[7:0]					0x00	R
0x229	REG0229	[7:0]			RESERVED				LUT_CORE[18]	LUT_BAND_18[8]	0x00	R
0x22A	REG022A	[7:0]				LUT_BAND_19[7:0]					0x00	R
0x22B	REG022B	[7:0]			RESERVED				LUT_CORE[19]	LUT_BAND_19[8]	0x00	R
0x22C	REG022C	[7:0]				LUT_BAND_20[7:0]					0x00	R
0x22D	REG022D	[7:0]			RESERVED				LUT_CORE[20]	LUT_BAND_20[8]	0x00	R

REGISTER MAP

Table 26. ADF4383 Register Summary (Continued)

Reg	Name	Bits	Bit 7	Bit 6	Bit 5	Bit 4	Bit 3	Bit 2	Bit 1	Bit 0	Reset	RW
0x22E	REG022E	[7:0]					LUT_BAND_21[7:0]				0x00	R
0x22F	REG022F	[7:0]				RESERVED			LUT_CORE[21]	LUT_BAND_21[8]	0x00	R
0x230	REG0230	[7:0]					LUT_BAND_22[7:0]				0x00	R
0x231	REG0231	[7:0]				RESERVED			LUT_CORE[22]	LUT_BAND_22[8]	0x00	R
0x232	REG0232	[7:0]					LUT_BAND_23[7:0]				0x00	R
0x233	REG0233	[7:0]				RESERVED			LUT_CORE[23]	LUT_BAND_23[8]	0x00	R
0x234	REG0234	[7:0]					LUT_BAND_24[7:0]				0x00	R
0x235	REG0235	[7:0]				RESERVED			LUT_CORE[24]	LUT_BAND_24[8]	0x00	R
0x236	REG0236	[7:0]					LUT_BAND_25[7:0]				0x00	R
0x237	REG0237	[7:0]				RESERVED			LUT_CORE[25]	LUT_BAND_25[8]	0x00	R
0x238	REG0238	[7:0]					LUT_BAND_26[7:0]				0x00	R
0x239	REG0239	[7:0]				RESERVED			LUT_CORE[26]	LUT_BAND_26[8]	0x00	R
0x23A	REG023A	[7:0]					LUT_BAND_27[7:0]				0x00	R
0x23B	REG023B	[7:0]				RESERVED			LUT_CORE[27]	LUT_BAND_27[8]	0x00	R
0x23C	REG023C	[7:0]					LUT_BAND_28[7:0]				0x00	R
0x23D	REG023D	[7:0]				RESERVED			LUT_CORE[28]	LUT_BAND_28[8]	0x00	R
0x23E	REG023E	[7:0]					LUT_BAND_29[7:0]				0x00	R
0x23F	REG023F	[7:0]				RESERVED			LUT_CORE[29]	LUT_BAND_29[8]	0x00	R
0x240	REG0240	[7:0]					LUT_BAND_30[7:0]				0x00	R
0x241	REG0241	[7:0]				RESERVED			LUT_CORE[30]	LUT_BAND_30[8]	0x00	R
0x242	REG0242	[7:0]					LUT_BAND_31[7:0]				0x00	R
0x243	REG0243	[7:0]				RESERVED			LUT_CORE[31]	LUT_BAND_31[8]	0x00	R
0x244	REG0244	[7:0]					LUT_N_0[7:0]				0x00	R
0x245	REG0245	[7:0]			LUT_N_1[3:0]			LUT_N_0[11:8]			0x00	R
0x246	REG0246	[7:0]					LUT_N_1[11:4]				0x00	R
0x247	REG0247	[7:0]					LUT_N_2[7:0]				0x00	R
0x248	REG0248	[7:0]			LUT_N_3[3:0]			LUT_N_2[11:8]			0x00	R
0x249	REG0249	[7:0]					LUT_N_3[11:4]				0x00	R
0x24A	REG024A	[7:0]					LUT_N_4[7:0]				0x00	R
0x24B	REG024B	[7:0]			LUT_N_5[3:0]			LUT_N_4[11:8]			0x00	R
0x24C	REG024C	[7:0]					LUT_N_5[11:4]				0x00	R
0x24D	REG024D	[7:0]					LUT_N_6[7:0]				0x00	R
0x24E	REG024E	[7:0]			LUT_N_7[3:0]			LUT_N_6[11:8]			0x00	R
0x24F	REG024F	[7:0]					LUT_N_7[11:4]				0x00	R
0x250	REG0250	[7:0]					LUT_N_8[7:0]				0x00	R
0x251	REG0251	[7:0]			LUT_N_9[3:0]			LUT_N_8[11:8]			0x00	R
0x252	REG0252	[7:0]					LUT_N_9[11:4]				0x00	R
0x253	REG0253	[7:0]					LUT_N_10[7:0]				0x00	R

REGISTER MAP

Table 26. ADF4383 Register Summary (Continued)

Reg	Name	Bits	Bit 7	Bit 6	Bit 5	Bit 4	Bit 3	Bit 2	Bit 1	Bit 0	Reset	RW
0x254	REG0254	[7:0]		LUT_N_11[3:0]				LUT_N_10[11:8]			0x00	R
0x255	REG0255	[7:0]					LUT_N_11[11:4]				0x00	R
0x256	REG0256	[7:0]					LUT_N_12[7:0]				0x00	R
0x257	REG0257	[7:0]		LUT_N_13[3:0]				LUT_N_12[11:8]			0x00	R
0x258	REG0258	[7:0]					LUT_N_13[11:4]				0x00	R
0x259	REG0259	[7:0]					LUT_N_14[7:0]				0x00	R
0x25A	REG025A	[7:0]		LUT_N_15[3:0]				LUT_N_14[11:8]			0x00	R
0x25B	REG025B	[7:0]					LUT_N_15[11:4]				0x00	R
0x25C	REG025C	[7:0]					LUT_N_16[7:0]				0x00	R
0x25D	REG025D	[7:0]		LUT_N_17[3:0]				LUT_N_16[11:8]			0x00	R
0x25E	REG025E	[7:0]					LUT_N_17[11:4]				0x00	R
0x25F	REG025F	[7:0]					LUT_N_18[7:0]				0x00	R
0x260	REG0260	[7:0]		LUT_N_19[3:0]				LUT_N_18[11:8]			0x00	R
0x261	REG0261	[7:0]					LUT_N_19[11:4]				0x00	R
0x262	REG0262	[7:0]					LUT_N_20[7:0]				0x00	R
0x263	REG0263	[7:0]		LUT_N_21[3:0]				LUT_N_20[11:8]			0x00	R
0x264	REG0264	[7:0]					LUT_N_21[11:4]				0x00	R
0x265	REG0265	[7:0]					LUT_N_22[7:0]				0x00	R
0x266	REG0266	[7:0]		LUT_N_23[3:0]				LUT_N_22[11:8]			0x00	R
0x267	REG0267	[7:0]					LUT_N_23[11:4]				0x00	R
0x268	REG0268	[7:0]					LUT_N_24[7:0]				0x00	R
0x269	REG0269	[7:0]		LUT_N_25[3:0]				LUT_N_24[11:8]			0x00	R
0x26A	REG026A	[7:0]					LUT_N_25[11:4]				0x00	R
0x26B	REG026B	[7:0]					LUT_N_26[7:0]				0x00	R
0x26C	REG026C	[7:0]		LUT_N_27[3:0]				LUT_N_26[11:8]			0x00	R
0x26D	REG026D	[7:0]					LUT_N_27[11:4]				0x00	R
0x26E	REG026E	[7:0]					LUT_N_28[7:0]				0x00	R
0x26F	REG026F	[7:0]		LUT_N_29[3:0]				LUT_N_28[11:8]			0x00	R
0x270	REG0270	[7:0]					LUT_N_29[11:4]				0x00	R
0x271	REG0271	[7:0]					LUT_N_30[7:0]				0x00	R
0x272	REG0272	[7:0]		LUT_N_31[3:0]				LUT_N_30[11:8]			0x00	R
0x273	REG0273	[7:0]					LUT_N_31[11:4]				0x00	R

REGISTER DETAILS

Address: 0x000, Reset: 0x00, Name: REG0000

Table 27. Bit Descriptions for REG0000

Bits	Bit Name	Description	Reset	Access
7	SOFT_RESET_R	Repeat of SOFT_RESET.	0x0	R/W
6	LSB_FIRST_R	Repeat of LSB_FIRST.	0x0	R/W
5	ADDRESS_ASCENSION_R	Repeat of ADDRESS_ASCENSION.	0x0	R/W
4	SDO_ACTIVE_R	Repeat of SDO_ACTIVE.	0x0	R/W
3	SDO_ACTIVE	Choose Between 3-Wire or 4-Wire Operation. 0: 3-wire. 1: 4-wire SPI (enables SDO and SDIO becomes an input only).	0x0	R/W
2	ADDRESS_ASCENSION	Address Ascension When Streaming. 0: address auto-decrements when streaming.	0x0	R/W

REGISTER MAP

Table 27. Bit Descriptions for REG0000 (Continued)

Bits	Bit Name	Description	Reset	Access
1	LSB_FIRST	1: address auto-increments when streaming. I/O Data Oriented LSB First. 0: MSB first. 1: LSB first.	0x0	R/W
0	SOFT_RESET	Reset SPI Registers Except REG0000 to POR State. Self-Clearing Reset 0: normal operation. 1: soft reset.	0x0	R/W

Address: 0x001, Reset: 0x00, Name: REG0001

Table 28. Bit Descriptions for REG0001

Bits	Bit Name	Description	Reset	Access
7	SINGLE_INSTRUCTION	Single Instruction. 0: SPI streaming enabled. 1: SPI streaming disabled.	0x0	R/W
6	REG01_RSV6	Reserved. The ADF4383 register map provides reserved register settings.	0x0	R/W
5	MAIN_READBACK_CONTROL	Main/Subordinate Readback Control. 0: For double buffered bit fields readback subordinate register. 1: For double buffered bit fields readback main register.	0x0	R/W
4	REG01_RSV4	Reserved. The ADF4383 register map provides reserved register settings.	0x0	R/W
3	RESERVED	Reserved.	0x0	R
2	REG01_RSV1	Reserved. The ADF4383 register map provides reserved register settings.	0x0	R/W
1	REG01_RSV0	Reserved. The ADF4383 register map provides reserved register settings.	0x0	R/W
0	RESERVED	Reserved.	0x0	R

Address: 0x003, Reset: 0x00, Name: REG0003

Table 29. Bit Descriptions for REG0003

Bits	Bit Name	Description	Reset	Access
[7:4]	RESERVED	Reserved.	0x0	R
[3:0]	CHIP_TYPE	Chip Type = 0x06.	0x0	R

Address: 0x004, Reset: 0x00, Name: REG0004

Table 30. Bit Descriptions for REG0004

Bits	Bit Name	Description	Reset	Access
[7:0]	PRODUCT_ID[7:0]	Product ID = 0x0008.	0x0	R

Address: 0x005, Reset: 0x00, Name: REG0005

Table 31. Bit Descriptions for REG0005

Bits	Bit Name	Description	Reset	Access
[7:0]	PRODUCT_ID[15:8]	Product ID = 0x0008.	0x0	R

Address: 0x00A, Reset: 0x00, Name: REG000A

REGISTER MAP

Table 32. Bit Descriptions for REG000A

Bits	Bit Name	Description	Reset	Access
[7:0]	SCRATCHPAD	SPI SCRATCHPAD.	0x0	R/W

Address: 0x00C, Reset: 0x56, Name: REG000C

Table 33. Bit Descriptions for REG000C

Bits	Bit Name	Description	Reset	Access
[7:0]	VENDOR_ID[7:0]	Vendor ID = 0x0456.	0x56	R

Address: 0x00D, Reset: 0x04, Name: REG000D

Table 34. Bit Descriptions for REG000D

Bits	Bit Name	Description	Reset	Access
[7:0]	VENDOR_ID[15:8]	Vendor ID = 0x0456.	0x4	R

Address: 0x010, Reset: 0x80, Name: REG0010

Table 35. Bit Descriptions for REG0010

Bits	Bit Name	Description	Reset	Access
[7:0]	N_INT[7:0]	12 Bit Integer Word for N-divider. Writing to Register 0x10 triggers autocalibration when EN_AUTOCAL = 1.	0x80	R/W

Address: 0x011, Reset: 0x00, Name: REG0011

Table 36. Bit Descriptions for REG0011

Bits	Bit Name	Description	Reset	Access
[7:5]	RFOUT_DIV	RFOUT Divider. 000: Divide by 1. 001: Divide by 2. 010: Divide by 4. 011: Divide by 8. 100: Divide by 16.	0x0	R/W
4	INV_RFOUT	Invert RFOUT1 and RFOUT2. 0: RFOUT1, RFOUT2 not inverted. 1: RFOUT1, RFOUT2 inverted.	0x0	R/W
[3:0]	N_INT[11:8]	12 Bit Integer Word for N-divider. Writing to Register 0x10 triggers autocalibration when EN_AUTOCAL = 1.	0x0	R/W

Address: 0x012, Reset: 0x00, Name: REG0012

Table 37. Bit Descriptions for REG0012

Bits	Bit Name	Description	Reset	Access
[7:0]	FRAC1WORD[7:0]	25 Bit N-Divider Frac1 Word.	0x0	R/W

Address: 0x013, Reset: 0x00, Name: REG0013

Table 38. Bit Descriptions for REG0013

Bits	Bit Name	Description	Reset	Access
[7:0]	FRAC1WORD[15:8]	25 Bit N-Divider Frac1 Word.	0x0	R/W

Address: 0x014, Reset: 0x00, Name: REG0014

REGISTER MAP

Table 39. Bit Descriptions for REG0014

Bits	Bit Name	Description	Reset	Access
[7:0]	FRAC1WORD[23:16]	25 Bit N-Divider Frac1 Word.	0x0	R/W

Address: 0x015, Reset: 0x00, Name: REG0015

Table 40. Bit Descriptions for REG0015

Bits	Bit Name	Description	Reset	Access
7	M_VCO_BAND[0]	Selects Band Within Core When O_VCO_BAND = 1.	0x0	R/W
6	M_VCO_CORE	Selects VCO Core When O_VCO_CORE = 1. 0: VCO 0 highest frequency. 1: VCO 1 lowest frequency.	0x0	R/W
[5:3]	RESERVED	Reserved.	0x0	R/W
2	INT_MODE	Integer Mode enabler. 0: fractional mode. 1: integer mode.	0x0	R/W
1	PFD_POL	PFD Polarity Bit for the Charge Pump.	0x0	R/W
0	FRAC1WORD[24]	25 Bit N-divider Frac1 Word.	0x0	R/W

Address: 0x016, Reset: 0x00, Name: REG0016

Table 41. Bit Descriptions for REG0016

Bits	Bit Name	Description	Reset	Access
[7:0]	M_VCO_BAND[8:1]	Selects Band Within Core When O_VCO_BAND = 1.	0x0	R/W

Address: 0x017, Reset: 0x00, Name: REG0017

Table 42. Bit Descriptions for REG0017

Bits	Bit Name	Description	Reset	Access
[7:0]	FRAC2WORD[7:0]	24 Bit N-Divider Frac2 Word.	0x0	R/W

Address: 0x018, Reset: 0x00, Name: REG0018

Table 43. Bit Descriptions for REG0018

Bits	Bit Name	Description	Reset	Access
[7:0]	FRAC2WORD[15:8]	24 Bit N-Divider Frac2 Word.	0x0	R/W

Address: 0x019, Reset: 0x00, Name: REG0019

Table 44. Bit Descriptions for REG0019

Bits	Bit Name	Description	Reset	Access
[7:0]	FRAC2WORD[23:16]	24 Bit N-Divider Frac2 Word.	0x0	R/W

Address: 0x01A, Reset: 0x00, Name: REG001A

Table 45. Bit Descriptions for REG001A

Bits	Bit Name	Description	Reset	Access
[7:0]	MOD2WORD[7:0]	24 Bits N-Divider Mod2 Word.	0x0	R/W

Address: 0x01B, Reset: 0x00, Name: REG001B

REGISTER MAP

Table 46. Bit Descriptions for REG001B

Bits	Bit Name	Description	Reset	Access
[7:0]	MOD2WORD[15:8]	24 Bits N-Divider Mod2 Word.	0x0	R/W

Address: 0x01C, Reset: 0x00, Name: REG001C

Table 47. Bit Descriptions for REG001C

Bits	Bit Name	Description	Reset	Access
[7:0]	MOD2WORD[23:16]	24 Bits N-Divider Mod2 Word.	0x0	R/W

Address: 0x01D, Reset: 0x00, Name: REG001D

Table 48. Bit Descriptions for REG001D

Bits	Bit Name	Description	Reset	Access
[7:0]	BLEED_I[7:0]	See the Charge Pump Bleed Current Optimization section.	0x0	R/W

Address: 0x01E, Reset: 0x00, Name: REG001E

Table 49. Bit Descriptions for REG001E

Bits	Bit Name	Description	Reset	Access
7	EN_PHASE_RESYNC	Enable the Phase Resync Mode. See the Phase Resynchronization section.	0x0	R/W
6	EN_REF_RST	If 1, SW_SYNC or the SYNC pin resets the RDIV and the REF counter.	0x0	R/W
5	TIMED_SYNC	Retime the synchronization signal with reference input clock. 0: RDIV and reference counter are reset asynchronously. 1: The synchronization signal is retimed with reference input clock.	0x0	R/W
[4:0]	BLEED_I[12:8]	See the Charge Pump Bleed Current Optimization section.	0x0	R/W

Address: 0x01F, Reset: 0x00, Name: REG001F

Table 50. Bit Descriptions for REG001F

Bits	Bit Name	Description	Reset	Access
7	SW_SYNC	Software SYNC Request.	0x0	R/W
6	RESERVED	Reserved.	0x0	R/W
5	BLEED_POL	Bleed Polarity. 0: current sink. 1: current source.	0x0	R/W
4	EN_BLEED	Enable Bleed Current. 0: bleed current disabled. 1: bleed current enabled.	0x0	R/W
[3:0]	CP_I	Charge Pump Current. 0000: 0.79 mA. 0001: 0.99 mA. 0010: 1.19 mA. 0011: 1.38 mA. 0100: 1.59 mA. 0101: 1.98 mA. 0110: 2.39 mA. 0111: 2.79 mA. 1000: 3.18 mA. 1001: 3.97 mA.	0x0	R/W

REGISTER MAP

Table 50. Bit Descriptions for REG001F (Continued)

Bits	Bit Name	Description	Reset	Access
		1010: 4.77 mA. 1011: 5.57 mA. 1100: 6.33 mA. 1101: 7.91 mA. 1110: 9.51 mA. 1111: 11.1 mA.		

Address: 0x020, Reset: 0x01, Name: REG0020

Table 51. Bit Descriptions for REG0020

Bits	Bit Name	Description	Reset	Access
7	EN_AUTOCAL	Enable VCO Calibration. 0: VCO calibration disabled. 1: VCO calibration enabled.	0x0	R/W
6	EN_RDBLR	Enable Reference Doubler. 0: doubler disabled. 1: doubler enabled.	0x0	R/W
[5:0]	R_DIV	6-Bit Reference Frequency Divider.	0x1	R/W

Address: 0x021, Reset: 0x00, Name: REG0021

Table 52. Bit Descriptions for REG0021

Bits	Bit Name	Description	Reset	Access
[7:0]	PHASE_WORD[7:0]	24-Bit Phase Word.	0x0	R/W

Address: 0x022, Reset: 0x00, Name: REG0022

Table 53. Bit Descriptions for REG0022

Bits	Bit Name	Description	Reset	Access
[7:0]	PHASE_WORD[15:8]	24-Bit Phase Word.	0x0	R/W

Address: 0x023, Reset: 0x00, Name: REG0023

Table 54. Bit Descriptions for REG0023

Bits	Bit Name	Description	Reset	Access
[7:0]	PHASE_WORD[23:16]	24-Bit Phase Word.	0x0	R/W

Address: 0x024, Reset: 0x00, Name: REG0024

Table 55. Bit Descriptions for REG0024

Bits	Bit Name	Description	Reset	Access
7	REF_CK_FALL	Timing from rising or falling edge of PFD RCLK. See Table 25 . 0: DRCLK is timed off of the rising edge of the PFD RCLK. 1: DRCLK is timed off of the falling edge of the PFD RCLK.	0x0	R/W
[6:5]	REF_DC_SEL	Sets the polarity of the RDIV output before the re-time. See Table 25 . 00: never invert (standard mode). 01: always invert. 10: automatically keep high duty cycle between 50% and 67%. 11: automatically keep high duty cycle between 33% and 50%.	0x0	R/W

REGISTER MAP

Table 55. Bit Descriptions for REG0024 (Continued)

Bits	Bit Name	Description	Reset	Access
4	DCLK_DIV_SEL	Selects Which Bit Field Controls DIV_NCLK Divider 1. 0: DIV_NCLK_DIVIDER1 Controlled by DCLK_DIV1 (Normal Operation). 1: DIV_NCLK_DIVIDER1 Controlled by DNCLK_DIV1.	0x0	R/W
[3:2]	DNCLK_DIV1	Controls DIV_NCLK Divider 1 when DCLK_DIV_SEL = 1. 00: divide by 1. 01: divide by 2. 10: divide by 4. 11: divide by 8.	0x0	R/W
[1:0]	DCLK_DIV1	Controls DIV_RCLK Div1. If DCLK_DIV_SEL = 0, then it also controls DIV_NCLK Divider1. See the VCO Calibration section. 00: divide by 1. 01: divide by 2. 10: divide by 4. 11: divide by 8.	0x0	R/W

Address: 0x025, Reset: 0x00, Name: REG0025

Table 56. Bit Descriptions for REG0025

Bits	Bit Name	Description	Reset	Access
[7:0]	RESYNC_WAIT[7:0]	Sets the waiting time after the calibration and sync pulse to apply the resynchronization. See the Phase Resynchronization section.	0x0	R/W

Address: 0x026, Reset: 0x00, Name: REG0026

Table 57. Bit Descriptions for REG0026

Bits	Bit Name	Description	Reset	Access
[7:0]	RESYNC_WAIT[15:8]	Sets the waiting time after the calibration and sync pulse to apply the resynchronization. See the Phase Resynchronization section.	0x0	R/W

Address: 0x027, Reset: 0x00, Name: REG0027

Table 58. Bit Descriptions for REG0027

Bits	Bit Name	Description	Reset	Access
[7:4]	REG027_RSV1	Reserved. The ADF4383 register map provides reserved register settings.	0x0	R/W
[3:0]	REG027_RSV0	Reserved. The ADF4383 register map provides reserved register settings.	0x0	R/W

Address: 0x028, Reset: 0x00, Name: REG0028

Table 59. Bit Descriptions for REG0028

Bits	Bit Name	Description	Reset	Access
7	PHASE_RESYNC_RB_SEL	Phase Resync Reset Selector.	0x0	R/W
6	LSB_P1	Add 1 to Σ - Δ LSB Enable/Disable.	0x0	R/W
5	VAR_MOD_EN	Enables Auxiliary Σ - Δ modulator.	0x0	R/W
[4:2]	DITHER1_SCALE	Selects the LSB Position for Dither 1.	0x0	R/W
1	EN_DITHER2	Dither Applied to Second Accumulator.	0x0	R/W
0	EN_DITHER1	Dither Applied to First Accumulator.	0x0	R/W

Address: 0x029, Reset: 0x00, Name: REG0029

REGISTER MAP

Table 60. Bit Descriptions for REG0029

Bits	Bit Name	Description	Reset	Access
[7:4]	RFOUT2_OPWR	Select RFOUT2 Output Amplitude.	0x0	R/W
[3:0]	RFOUT1_OPWR	Select RFOUT1 Output Amplitude.	0x0	R/W

Address: 0x02A, Reset: 0x04, Name: REG002A

Table 61. Bit Descriptions for REG002A

Bits	Bit Name	Description	Reset	Access
7	REG2A_RSV7	Reserved. The ADF4383 register map provides reserved register settings.	0x0	R/W
6	REG2A_RSV6	Reserved. The ADF4383 register map provides reserved register settings.	0x0	R/W
5	REG2A_RSV5	Reserved. The ADF4383 register map provides reserved register settings.	0x0	R/W
4	PD_SYNC	Power Down the Sync.	0x0	R/W
3	REG2A_RSV3	Reserved. The ADF4383 register map provides reserved register settings.	0x0	R/W
2	PD_RDET	Power Down the Reference Detector. 0: normal operation. 1: power down the reference detector.	0x1	R/W
1	PD_ADC	Power Down the Temperature ADC.	0x0	R/W
0	REG2A_RSV0	Reserved. The ADF4383 register map provides reserved register settings.	0x0	R/W

Address: 0x02B, Reset: 0x83, Name: REG002B

Table 62. Bit Descriptions for REG002B

Bits	Bit Name	Description	Reset	Access
7	PD_ALL	Main Power Down. 0: normal operation. 1: power down.	0x1	R/W
6	PD_RDIV	Power-Down the R-Divider. 0: normal operation. 1: power down R-divider.	0x0	R/W
5	PD_NDIV	Power-Down the N-Divider. 0: normal operation. 1: power down N-divider.	0x0	R/W
4	PD_VCO	Power-Down the VCO. 0: normal operation. 1: power down VCO.	0x0	R/W
3	PD_LD	Power-Down the Lock Detector. 0: normal operation. 1: power down the lock detector.	0x0	R/W
2	PD_PFDPCP	Power-Down the PFD Charge Pump. 0: normal operation. 1: power down the PFD charge pump.	0x0	R/W
1	PD_RFOUT1	Power-Down RFOUT1 Output Buffer. 0: normal operation. 1: power down RFOUT1 output.	0x1	R/W
0	PD_RFOUT2	Power-Down RFOUT2 Output Buffer. 0: normal operation. 1: power down RFOUT2 output.	0x1	R/W

Address: 0x02C, Reset: 0x00, Name: REG002C

REGISTER MAP

Table 63. Bit Descriptions for REG002C

Bits	Bit Name	Description	Reset	Access
[7:5]	LDWIN_PW	Lock Detector Pulse Window Width.	0x0	R/W
[4:0]	LD_COUNT	Number of PFD Cycles Before Lock Detector Goes High. See Lock Detector section. Number of PFD Cycles Before Lock Detector Goes High. See the Lock Detector section.	0x0	R/W

Address: 0x02D, Reset: 0x00, Name: REG002D

Table 64. Bit Descriptions for REG002D

Bits	Bit Name	Description	Reset	Access
7	EN_DNCLK	Enable DIV_NCLK to the Digital Block. 0: DIV_NCLK off. 1: DIV_NCLK on.	0x0	R/W
6	EN_DRCLK	Enable DIV_RCLK to the Digital Block. 0: DIV_RCLK off. 1: DIV_RCLK on.	0x0	R/W
5	EN_LOL	Enable Loss of Lock Detector. 0: disable loss of lock detector. 1: enable loss of lock detector.	0x0	R/W
4	EN_LDWIN	Enable the Lock Detector Pulse Window. 0: lock detector pulse window disabled. 1: lock detector pulse window enabled.	0x0	R/W
3	REG2D_RSV3	Reserved. The ADF4383 register map provides reserved register settings.	0x0	R/W
2	RST_LD	Reset Lock Detector to the Unlocked State. 0: reset inactive. 1: reset active.	0x0	R/W
1	REG2D_RSV1	Reserved. The ADF4383 register map provides reserved register settings.	0x0	R/W
0	REG2D_RSV0	Reserved. The ADF4383 register map provides reserved register settings.	0x0	R/W

Address: 0x02E, Reset: 0x00, Name: REG002E

Table 65. Bit Descriptions for REG002E

Bits	Bit Name	Description	Reset	Access
[7:4]	MUXOUT	Select Test Signal to MUXOUT. 0000: High-Z. 0001: Lock detector output. 0100: $f_{DIV_RCLK}/2$. 0101: $f_{DIV_NCLK}/2$. 0111: Logic low. 1000: Logic high.	0x0	R/W
3	RESERVED	Reserved.	0x0	R/W
2	EN_CPTEST	Enable Charge Pump Force Up or Down Test Mode. 0: Charge pump force up/down test mode off (normal operation). 1: Charge pump force up/down test mode on.	0x0	R/W
1	CP_DOWN	Force Pump Down Charge Pump Test Mode. 0: force pump down off. 1: force pump down on.	0x0	R/W
0	CP_UP	Force Pump Up Charge Pump Test Mode. 0: force pump up off. 1: force pump up on.	0x0	R/W

REGISTER MAP

Address: 0x02F, Reset: 0x00, Name: REG002F

Table 66. Bit Descriptions for REG002F

Bits	Bit Name	Description	Reset	Access
7	BST_REF	Gain boost for low amplitude sinewave reference input (REF_SEL = 1). 0: Use for large ref input signals > 8dBm when REF_SEL = 1. 1: Use for ref input signals < 8dBm when REF_SEL = 1.	0x0	R/W
6	FILT_REF	Select Noise Filter for Sinewave Ref Input Buffer. 0: noise filter off. 1: noise filter on.	0x0	R/W
[5:0]	RDBLR_DC	Reference Doubler Output Duty-cycle. See Table 11.	0x0	R/W

Address: 0x030, Reset: 0x00, Name: REG0030

Table 67. Bit Descriptions for REG0030

Bits	Bit Name	Description	Reset	Access
7	MUTE_NCLK	Mutes the N-divider output to digital block. Set to 0 for normal operation.	0x0	R/W
6	RESERVED	Reserved.	0x0	R/W
5	REF_SEL	Select CML reference input or sine-wave and slow slew-rate reference input. 0: CML reference input. 1: Sinewave or slow slew-rate ref input.	0x0	R/W
4	INV_RDBLR	Invert the Reference Doubler Output. See Table 11. 0: Doubler Output Not Inverted. 1: Doubler Output Inverted.	0x0	R/W
[3:0]	RDBLR_DEL_SEL	Sets the Doubler Pulse Width. See Table 11.	0x0	R/W

Address: 0x031, Reset: 0x00, Name: REG0031

Table 68. Bit Descriptions for REG0031

Bits	Bit Name	Description	Reset	Access
[7:5]	SYNC_DEL	Sets the programmable input delay for the synchronization path. See Table 25.	0x0	R/W
4	RST_SYS	Reset Digital Except SPI and Registers to POR State. 0: reset inactive. 1: reset active.	0x0	R/W
3	EN_ADC_CLK	Enable the ADC Clock. 0: disable ADC clock. 1: enable ADC clock.	0x0	R/W
2	RESERVED	Reserved.	0x0	R/W
1	REG31_RSV1	Reserved. ADF4383 register map provides reserved register settings.	0x0	R/W
0	DCLK_MODE	Divide RCLK and NCLK frequency by factor of 2 during VCO calibration. 0: disable frequency division. 1: enable frequency division.	0x0	R/W

Address: 0x032, Reset: 0x00, Name: REG0032

Table 69. Bit Descriptions for REG0032

Bits	Bit Name	Description	Reset	Access
7	RESERVED	Reserved.	0x0	R/W
6	REG32_RSV6	Reserved. The ADF4383 register map provides reserved register settings.	0x0	R/W
5	DEL_MODE	Select the Adjustment Mode to Use.	0x0	R/W

REGISTER MAP

Table 69. Bit Descriptions for REG0032 (Continued)

Bits	Bit Name	Description	Reset	Access
		0: charge pump bleed mode. 1: Σ - Δ mode.		
4	EN_AUTO_ALIGN	Enable Clock Align Mode. 0: phase adjustment is performed using a SPI write by setting PHASE_ADJ. 1: phase adjustment is performed using DEL_STR and DEL_ADJ pins.	0x0	R/W
3	PHASE_ADJ_POL	Determines the Polarity of the Phase Adjustment. 0: subtracts the selected phase value. 1: add the selected phase value.	0x0	R/W
[2:0]	EFM3_MODE	See the Σ-Δ Modulator Optimization Modes section.	0x0	R/W

Address: 0x033, Reset: 0x00, Name: REG0033

Table 70. Bit Descriptions for REG0033

Bits	Bit Name	Description	Reset	Access
[7:0]	PHASE_ADJUSTMENT	See the Phase Adjust section.	0x0	R/W

Address: 0x034, Reset: 0x00, Name: REG0034

Table 71. Bit Descriptions for REG0034

Bits	Bit Name	Description	Reset	Access
7	PHASE_ADJ	Apply the phase adjustment value set in PHASE_ADJUSTMENT.	0x0	R/W
[6:4]	DRCLK_DEL	Sets the programmable input delay for the digital RCLK path. See Table 25 .	0x0	R/W
[3:1]	DNCLK_DEL	Sets the programmable input delay for the digital NCLK path. See Table 25 .	0x0	R/W
0	RST_CNTR	Reset for Frequency Counter Test Mode.	0x0	R/W

Address: 0x035, Reset: 0x00, Name: REG0035

Table 72. Bit Descriptions for REG0035

Bits	Bit Name	Description	Reset	Access
[7:6]	RESERVED	Reserved.	0x0	R/W
[5:0]	M_VCO_BIAS	Selects the Bias Value Used When O_VCO_BIAS = 1.	0x0	R/W

Address: 0x036, Reset: 0x00, Name: REG0036

Table 73. Bit Descriptions for REG0036

Bits	Bit Name	Description	Reset	Access
7	RFOUTODIV_DB	RFOUTO_DIV Double Buffered.	0x0	R/W
6	DCLK_DIV_DB	DCLK_DIV1 and DNCLK_DIV1 Double Buffered.	0x0	R/W
[5:2]	RESERVED	Reserved.	0x0	R/W
1	EN_LUT_GEN	Enable the LUT generation.	0x0	R/W
0	EN_LUT_CAL	Enable the Use of the Lookup Table for the Calibration.	0x0	R/W

Address: 0x037, Reset: 0x00, Name: REG0037

Table 74. Bit Descriptions for REG0037

Bits	Bit Name	Description	Reset	Access
[7:0]	CAL_COUNT_TO	Timeout value for each VCO calibration decision. See the VCO Calibration section.	0x0	R/W

REGISTER MAP

Address: 0x038, Reset: 0x00, Name: REG0038

Table 75. Bit Descriptions for REG0038

Bits	Bit Name	Description	Reset	Access
[7:0]	CAL_VTUNE_TO[7:0]	Timeout value for VCO VTUNE settling. See the VCO Calibration section.	0x0	R/W

Address: 0x039, Reset: 0x00, Name: REG0039

Table 76. Bit Descriptions for REG0039

Bits	Bit Name	Description	Reset	Access
7	O_VCO_DB	M_VCO_CORE, M_VCO_BAND, and M_VCO_BIAS Doubled Buffered. See the VCO Calibration section. 0: core, bias and band not double buffered. 1: core, bias and band double buffered.	0x0	R/W
[6:0]	CAL_VTUNE_TO[14:8]	Timeout value for VCO VTUNE settling. See the VCO Calibration section.	0x0	R/W

Address: 0x03A, Reset: 0x00, Name: REG003A

Table 77. Bit Descriptions for REG003A

Bits	Bit Name	Description	Reset	Access
[7:0]	CAL_VCO_TO[7:0]	Timeout value for VCO calibration band and core settling. See the VCO Calibration section.	0x0	R/W

Address: 0x03B, Reset: 0x00, Name: REG003B

Table 78. Bit Descriptions for REG003B

Bits	Bit Name	Description	Reset	Access
7	DEL_CTRL_DB	Delay Controls Double Buffered. 0: not double buffered. 1: double buffered.	0x0	R/W
[6:0]	CAL_VCO_TO[14:8]	Timeout value for VCO calibration band and core settling. See the VCO Calibration section.	0x0	R/W

Address: 0x03C, Reset: 0x00, Name: REG003C

Table 79. Bit Descriptions for REG003C

Bits	Bit Name	Description	Reset	Access
[7:0]	REG3C_RSV0	Reserved. The ADF4383 register map provides reserved register settings.	0x0	R/W

Address: 0x03D, Reset: 0x00, Name: REG003D

Table 80. Bit Descriptions for REG003D

Bits	Bit Name	Description	Reset	Access
7	RESERVED	Reserved.	0x0	R/W
6	REG3C_RSV6	Reserved. The ADF4383 register map provides reserved register settings.	0x0	R/W
5	CMOS_OV	Logic High Voltage for MUXOUT, LKDET, SDO, SDIO. 0: 1.8 V logic. 1: 3.3 V logic.	0x0	R/W
4	REG3D_RSV1	Reserved. The ADF4383 register map provides reserved register settings.	0x0	R/W
[3:0]	REG3D_RSV0	Reserved. The ADF4383 register map provides reserved register settings.	0x0	R/W

Address: 0x03E, Reset: 0x00, Name: REG003E

REGISTER MAP

Table 81. Bit Descriptions for REG003E

Bits	Bit Name	Description	Reset	Access
[7:0]	ADC_CLK_DIV	ADC Clock Frequency = (DIV_RCLK Frequency)/((ADC_CLK_DIV × 4) + 2).	0x0	R/W

Address: 0x03F, Reset: 0x00, Name: REG003F

Table 82. Bit Descriptions for REG003F

Bits	Bit Name	Description	Reset	Access
7	REG3F_RSV7	Reserved. The ADF4383 register map provides reserved register settings.	0x0	R/W
6	REG3F_RSV6	Reserved. The ADF4383 register map provides reserved register settings.	0x0	R/W
5	REG3F_RSV5	Reserved. The ADF4383 register map provides reserved register settings.	0x0	R/W
4	REG3F_RSV4	Reserved. The ADF4383 register map provides reserved register settings.	0x0	R/W
3	REG3F_RSV3	Reserved. The ADF4383 register map provides reserved register settings.	0x0	R/W
2	REG3F_RSV2	Reserved. ADF4383 register map provides reserved register settings.	0x0	R/W
1	EN_ADC	Enable ADC. 0: ADC disabled. 1: ADC enabled.	0x0	R/W
0	REG3F_RSV0	Reserved. The ADF4383 register map provides reserved register settings.	0x0	R/W

Address: 0x040, Reset: 0x00, Name: REG0040

Table 83. Bit Descriptions for REG0040

Bits	Bit Name	Description	Reset	Access
7	REG40_RSV7	Reserved. The ADF4383 register map provides reserved register settings.	0x0	R/W
6	REG40_RSV6	Reserved. The ADF4383 register map provides reserved register settings.	0x0	R/W
[5:3]	MUTE_RFOUT2	Mute Control for RFOUT2 Buffer. See the Mute RF Output section.	0x0	R/W
[2:0]	MUTE_RFOUT1	Mute Control for RFOUT1 Buffer. See the Mute RF Output section.	0x0	R/W

Address: 0x041, Reset: 0x00, Name: REG0041

Table 84. Bit Descriptions for REG0041

Bits	Bit Name	Description	Reset	Access
[7:5]	REG41_RSV5	Reserved. The ADF4383 register map provides reserved register settings.	0x0	R/W
4	REG41_RSV4	Reserved. The ADF4383 register map provides reserved register settings.	0x0	R/W
3	REG41_RSV3	Reserved. The ADF4383 register map provides reserved register settings.	0x0	R/W
2	REG41_RSV2	Reserved. The ADF4383 register map provides reserved register settings.	0x0	R/W
1	REG41_RSV1	Reserved. The ADF4383 register map provides reserved register settings.	0x0	R/W
0	REG41_RSV0	Reserved. The ADF4383 register map provides reserved register settings.	0x0	R/W

Address: 0x042, Reset: 0x00, Name: REG0042

Table 85. Bit Descriptions for REG0042

Bits	Bit Name	Description	Reset	Access
[7:0]	REG42_RSV0	Reserved. The ADF4383 register map provides reserved register settings.	0x0	R/W

Address: 0x043, Reset: 0x00, Name: REG0043

Table 86. Bit Descriptions for REG0043

Bits	Bit Name	Description	Reset	Access
[7:0]	REG43_RSV0	Reserved. The ADF4383 register map provides reserved register settings.	0x0	R/W

REGISTER MAP

Address: 0x044, Reset: 0x00, Name: REG0044

Table 87. Bit Descriptions for REG0044

Bits	Bit Name	Description	Reset	Access
7	VCAL_ZERO	Extends the range of loop filter component values over which the VCAL generation amplifier driving VTUNE is stable.	0x0	R/W
[6:0]	REG44_RSV0	Programmable increasing with temperature component of VCAL.	0x0	R/W

Address: 0x045, Reset: 0x00, Name: REG0045

Table 88. Bit Descriptions for REG0045

Bits	Bit Name	Description	Reset	Access
7	RESERVED	Reserved.	0x0	R/W
[6:0]	REG45_RSV0	Programmable decreasing with temperature component of VCAL.	0x0	R/W

Address: 0x04B, Reset: 0x00, Name: REG004B

Table 89. Bit Descriptions for REG004B

Bits	Bit Name	Description	Reset	Access
[7:0]	REG4B_RSV0	Reserved. The ADF4383 register map provides reserved register settings.	0x0	R/W

Address: 0x04C, Reset: 0x00, Name: REG004C

Table 90. Bit Descriptions for REG004C

Bits	Bit Name	Description	Reset	Access
[7:6]	RESERVED	Reserved.	0x0	R/W
[5:0]	REG4C_RSV0	Reserved. The ADF4383 register map provides reserved register settings.	0x0	R/W

Address: 0x04D, Reset: 0x00, Name: REG004D

Table 91. Bit Descriptions for REG004D

Bits	Bit Name	Description	Reset	Access
[7:3]	RESERVED	Reserved.	0x0	R/W
2	O_VCO_BIAS	Override VCO Bias with M_VCO_BIAS.	0x0	R/W
1	O_VCO_BAND	Override VCO Band with M_VCO_BAND. 0: VCO Band Code from VCO Calibration State-machine. 1: VCO Band Code from M_VCO_BAND.	0x0	R/W
0	O_VCO_CORE	Override VCO Core with M_VCO_CORE. 0: VCO Core Select from VCO Calibration State-machine. 1: VCO Core Select from M_VCO_CORE.	0x0	R/W

Address: 0x04F, Reset: 0x00, Name: REG004F

Table 92. Bit Descriptions for REG004F

Bits	Bit Name	Description	Reset	Access
[7:0]	LUT_SCALE	Set the scaling factor for the use of the LUT: $LUT_SCALE = (f_{PFD}/PFD \text{ LUT Frequency } (f_{PFDLUT})) \times 8$. 00: Scale the LUT by 0.0625. 01: Scale the LUT by 1. 10: Scale the LUT by 15.9375.	0x0	R/W

REGISTER MAP

Address: 0x053, Reset: 0x00, Name: REG0053

Table 93. Bit Descriptions for REG0053

Bits	Bit Name	Description	Reset	Access
7	RESERVED	Reserved.	0x0	R/W
6	PD_SYNC_MON	Power down the SYNC setup and hold monitor. 0: Normal Operation. 1: Power down the SYNC setup/hold monitor.	0x0	R/W
5	SYNC_SEL	Syncs the CML/PECL input or LVDS input. 0: CML/PECL input. 1: LVDS input.	0x0	R/W
4	RST_SYNC_MON	Clear the output latch of the setup and hold monitor. 0: Reset Inactive. 1: Reset Active.	0x0	R/W
[3:0]	REG53_RSV0	Reserved. the ADF4383 register map provides reserved register settings.	0x0	R/W

Address: 0x054, Reset: 0x00, Name: REG0054

Table 94. Bit Descriptions for REG0054

Bits	Bit Name	Description	Reset	Access
[7:1]	RESERVED	Reserved.	0x0	R
0	ADC_ST_CNV	Starts an ADC conversion.	0x0	R/W

Address: 0x055, Reset: 0x00, Name: REG0055

Table 95. Bit Descriptions for REG0055

Bits	Bit Name	Description	Reset	Access
[7:0]	COUNTER_READBACK[7:0]	Frequency Counter Output.	0x0	R

Address: 0x056, Reset: 0x00, Name: REG0056

Table 96. Bit Descriptions for REG0056

Bits	Bit Name	Description	Reset	Access
[7:0]	COUNTER_READBACK[15:8]	Frequency Counter Output.	0x0	R

Address: 0x057, Reset: 0x00, Name: REG0057

Table 97. Bit Descriptions for REG0057

Bits	Bit Name	Description	Reset	Access
[7:0]	COUNTER_READBACK[23:16]	Frequency Counter Output.	0x0	R

Address: 0x058, Reset: 0x00, Name: REG0058

Table 98. Bit Descriptions for REG0058

Bits	Bit Name	Description	Reset	Access
7	LUT_BUSY	VCO LUT Generation Status.	0x0	R
6	SYNC_OK	SYNC is setup/hold time with respect to reference indicator. 0: SYNC is not in correct setup and hold with respect to reference. 1: SYNC is in correct setup and hold with respect to reference.	0x0	R
5	DEL_STR	Delay Strobe Indicator.	0x0	R
4	DEL_ADJ	Delay Adjust Direction Indicator.	0x0	R

REGISTER MAP

Table 98. Bit Descriptions for REG0058 (Continued)

Bits	Bit Name	Description	Reset	Access
		0: Negative phase adjustment. 1: Positive phase adjustment.		
3	REF_OK	Reference Input Amplitude Threshold Indicator. 0: Reference input amplitude below threshold. 1: Reference input amplitude above threshold.	0x0	R
2	ADC_BUSY	ADC Conversion Status. 0: ADC conversion not in progress. 1: ADC conversion in progress.	0x0	R
1	FSM_BUSY	VCO Calibration Status. 0: VCO calibration not in progress. 1: VCO calibration in progress.	0x0	R
0	LOCKED	Lock Detector Output. 0: Not Locked. 1: Locked.	0x0	R

Address: 0x059, Reset: 0x00, Name: REG0059

Table 99. Bit Descriptions for REG0059

Bits	Bit Name	Description	Reset	Access
[7:6]	RESERVED	Reserved.	0x0	R
[5:0]	VCO0_BIAS_RDBK	VCO Bias Selected for Core 0.	0x0	R

Address: 0x05A, Reset: 0x00, Name: REG005A

Table 100. Bit Descriptions for REG005A

Bits	Bit Name	Description	Reset	Access
[7:6]	RESERVED	Reserved.	0x0	R
[5:0]	VCO1_BIAS_RDBK	VCO Bias Selected for Core 1.	0x0	R

Address: 0x05B, Reset: 0x00, Name: REG005B

Table 101. Bit Descriptions for REG005B

Bits	Bit Name	Description	Reset	Access
[7:0]	CHIP_TEMP[7:0]	Temperature measured by the ADC in degrees Celsius. Bit 8 = Sign, Bits[7:0] = Magnitude.	0x0	R

Address: 0x05C, Reset: 0x00, Name: REG005C

Table 102. Bit Descriptions for REG005C

Bits	Bit Name	Description	Reset	Access
[7:1]	RESERVED	Reserved.	0x0	R
0	CHIP_TEMP[8]	Temperature Measured by the ADC in degrees Celsius. Bit 8 = Sign, Bits[7:0] = Magnitude.	0x0	R

Address: 0x05E, Reset: 0x00, Name: REG005E

Table 103. Bit Descriptions for REG005E

Bits	Bit Name	Description	Reset	Access
[7:0]	VCO_BAND[7:0]	VCO Band Selected.	0x0	R

Address: 0x05F, Reset: 0x00, Name: REG005F

REGISTER MAP

Table 104. Bit Descriptions for REG005F

Bits	Bit Name	Description	Reset	Access
[7:2]	RESERVED	Reserved.	0x0	R
1	VCO_CORE	VCO Core Selected.	0x0	R
0	VCO_BAND[8]	VCO Band Selected.	0x0	R

Address: 0x061, Reset: 0x00, Name: REG0061

Table 105. Bit Descriptions for REG0061

Bits	Bit Name	Description	Reset	Access
[7:0]	CUM_PHASE_ADJ[7:0]	See the Phase Adjust section.	0x0	R

Address: 0x062, Reset: 0x00, Name: REG0062

Table 106. Bit Descriptions for REG0062

Bits	Bit Name	Description	Reset	Access
[7:0]	CUM_PHASE_ADJ[15:8]	See the Phase Adjust section.	0x0	R

Address: 0x063, Reset: 0x00, Name: REG0063

Table 107. Bit Descriptions for REG0063

Bits	Bit Name	Description	Reset	Access
[7:1]	RESERVED	Reserved.	0x0	R
0	CUM_PHASE_ADJ[16]	See the Phase Adjust section.	0x0	R

Address: 0x064, Reset: 0x00, Name: REG0064

Table 108. Bit Descriptions for REG0064

Bits	Bit Name	Description	Reset	Access
[7:0]	DEL_CNT[7:0]	Bleed code sent to the charge pump.	0x0	R

Address: 0x065, Reset: 0x00, Name: REG0065

Table 109. Bit Descriptions for REG0065

Bits	Bit Name	Description	Reset	Access
[7:0]	DEL_CNT[15:8]	Bleed code sent to the charge pump.	0x0	R

Address: 0x066, Reset: 0x00, Name: REG0066

Table 110. Bit Descriptions for REG0066

Bits	Bit Name	Description	Reset	Access
[7:0]	FIRST_PASS_VCO_BAND	Band selected in first pass of the VCO calibration.	0x0	R

Address: 0x067, Reset: 0x00, Name: REG0067

Table 111. Bit Descriptions for REG0067

Bits	Bit Name	Description	Reset	Access
[7:0]	VERSION	Chip Version.	0x0	R

Address: 0x100, Reset: 0x00, Name: REG0100

REGISTER MAP

Table 112. Bit Descriptions for REG0100

Bits	Bit Name	Description	Reset	Access
[7:6]	RESERVED	Reserved.	0x0	R
[5:0]	CORE0_BIAS_TABLE_0	Automatic Value for the Bias Code When $16 > \text{Band} \geq 0$ and $\text{Core} = 0$. The ADF4383 register map provides register settings.	0x0	R/W

Address: 0x101, Reset: 0x00, Name: REG0101

Table 113. Bit Descriptions for REG0101

Bits	Bit Name	Description	Reset	Access
[7:6]	RESERVED	Reserved.	0x0	R
[5:0]	CORE0_BIAS_TABLE_1	Automatic Value for the Bias Code When $32 > \text{Band} \geq 16$ and $\text{Core} = 0$. The ADF4383 register map provides register settings.	0x0	R/W

Address: 0x102, Reset: 0x00, Name: REG0102

Table 114. Bit Descriptions for REG0102

Bits	Bit Name	Description	Reset	Access
[7:6]	RESERVED	Reserved.	0x0	R
[5:0]	CORE0_BIAS_TABLE_2	Automatic Value for the Bias Code When $64 > \text{Band} \geq 32$ and $\text{Core} = 0$. The ADF4383 register map provides register settings.	0x0	R/W

Address: 0x103, Reset: 0x00, Name: REG0103

Table 115. Bit Descriptions for REG0103

Bits	Bit Name	Description	Reset	Access
[7:6]	RESERVED	Reserved.	0x0	R
[5:0]	CORE0_BIAS_TABLE_3	Automatic Value for the Bias Code When $128 > \text{Band} \geq 64$ and $\text{Core} = 0$. The ADF4383 register map provides register settings.	0x0	R/W

Address: 0x104, Reset: 0x00, Name: REG0104

Table 116. Bit Descriptions for REG0104

Bits	Bit Name	Description	Reset	Access
[7:6]	RESERVED	Reserved.	0x0	R
[5:0]	CORE0_BIAS_TABLE_4	Automatic Value for the Bias Code When $192 > \text{Band} \geq 128$ and $\text{Core} = 0$. The ADF4383 register map provides register settings.	0x0	R/W

Address: 0x105, Reset: 0x00, Name: REG0105

Table 117. Bit Descriptions for REG0105

Bits	Bit Name	Description	Reset	Access
[7:6]	RESERVED	Reserved.	0x0	R
[5:0]	CORE0_BIAS_TABLE_5	Automatic Value for the Bias Code When $256 > \text{Band} \geq 192$ and $\text{Core} = 0$. The ADF4383 register map provides register settings.	0x0	R/W

Address: 0x106, Reset: 0x00, Name: REG0106

Table 118. Bit Descriptions for REG0106

Bits	Bit Name	Description	Reset	Access
[7:6]	RESERVED	Reserved.	0x0	R

REGISTER MAP

Table 118. Bit Descriptions for REG0106 (Continued)

Bits	Bit Name	Description	Reset	Access
[5:0]	CORE0_BIAS_TABLE_6	Automatic Value for the Bias Code When $320 > \text{Band} \geq 256$ and $\text{Core} = 0$. The ADF4383 register map provides register settings.	0x0	R/W

Address: 0x107, Reset: 0x00, Name: REG0107

Table 119. Bit Descriptions for REG0107

Bits	Bit Name	Description	Reset	Access
[7:6]	RESERVED	Reserved.	0x0	R
[5:0]	CORE0_BIAS_TABLE_7	Automatic Value for the Bias Code When $416 > \text{Band} \geq 320$ and $\text{Core} = 0$. The ADF4383 register map provides register settings.	0x0	R/W

Address: 0x108, Reset: 0x00, Name: REG0108

Table 120. Bit Descriptions for REG0108

Bits	Bit Name	Description	Reset	Access
[7:6]	RESERVED	Reserved.	0x0	R
[5:0]	CORE0_BIAS_TABLE_8	Automatic Value for the Bias Code When $512 > \text{Band} \geq 416$ and $\text{Core} = 0$. The ADF4383 register map provides register settings.	0x0	R/W

Address: 0x109, Reset: 0x00, Name: REG0109

Table 121. Bit Descriptions for REG0109

Bits	Bit Name	Description	Reset	Access
[7:6]	RESERVED	Reserved.	0x0	R
[5:0]	CORE1_BIAS_TABLE_0	Automatic Value for the Bias Code When $16 > \text{Band} \geq 0$ and $\text{Core} = 1$. The ADF4383 register map provides register settings.	0x0	R/W

Address: 0x10A, Reset: 0x00, Name: REG010A

Table 122. Bit Descriptions for REG010A

Bits	Bit Name	Description	Reset	Access
[7:6]	RESERVED	Reserved.	0x0	R
[5:0]	CORE1_BIAS_TABLE_1	Automatic Value for the Bias Code When $32 > \text{Band} \geq 16$ and $\text{Core} = 1$. The ADF4383 register map provides register settings.	0x0	R/W

Address: 0x10B, Reset: 0x00, Name: REG010B

Table 123. Bit Descriptions for REG010B

Bits	Bit Name	Description	Reset	Access
[7:6]	RESERVED	Reserved.	0x0	R
[5:0]	CORE1_BIAS_TABLE_2	Automatic Value for the Bias Code When $64 > \text{Band} \geq 32$ and $\text{Core} = 1$. The ADF4383 register map provides register settings.	0x0	R/W

Address: 0x10C, Reset: 0x00, Name: REG010C

Table 124. Bit Descriptions for REG010C

Bits	Bit Name	Description	Reset	Access
[7:6]	RESERVED	Reserved.	0x0	R
[5:0]	CORE1_BIAS_TABLE_3	Automatic Value for the Bias Code When $128 > \text{Band} \geq 64$ and $\text{Core} = 1$. The ADF4383 register map provides register settings.	0x0	R/W

REGISTER MAP

Address: 0x10D, Reset: 0x00, Name: REG010D

Table 125. Bit Descriptions for REG010D

Bits	Bit Name	Description	Reset	Access
[7:6]	RESERVED	Reserved.	0x0	R
[5:0]	CORE1_BIAS_TABLE_4	Automatic Value for the Bias Code When $192 > \text{Band} \geq 128$ and Core = 1. The ADF4383 register map provides register settings.	0x0	R/W

Address: 0x10E, Reset: 0x00, Name: REG010E

Table 126. Bit Descriptions for REG010E

Bits	Bit Name	Description	Reset	Access
[7:6]	RESERVED	Reserved.	0x0	R
[5:0]	CORE1_BIAS_TABLE_5	Automatic Value for the Bias Code When $256 > \text{Band} \geq 192$ and Core = 1. The ADF4383 register map provides register settings.	0x0	R/W

Address: 0x10F, Reset: 0x00, Name: REG010F

Table 127. Bit Descriptions for REG010F

Bits	Bit Name	Description	Reset	Access
[7:6]	RESERVED	Reserved.	0x0	R
[5:0]	CORE1_BIAS_TABLE_6	Automatic Value for the Bias Code When $320 > \text{Band} \geq 256$ and Core = 1. The ADF4383 register map provides register settings.	0x0	R/W

Address: 0x110, Reset: 0x00, Name: REG0110

Table 128. Bit Descriptions for REG0110

Bits	Bit Name	Description	Reset	Access
[7:6]	RESERVED	Reserved.	0x0	R
[5:0]	CORE1_BIAS_TABLE_7	Automatic Value for the Bias Code When $416 > \text{Band} \geq 320$ and Core = 1. The ADF4383 register map provides register settings.	0x0	R/W

Address: 0x111, Reset: 0x00, Name: REG0111

Table 129. Bit Descriptions for REG0111

Bits	Bit Name	Description	Reset	Access
[7:6]	RESERVED	Reserved.	0x0	R
[5:0]	CORE1_BIAS_TABLE_8	Automatic Value for the Bias Code When $512 > \text{Band} \geq 416$ and Core = 1. The ADF4383 register map provides register settings.	0x0	R/W

Address: 0x200, Reset: 0x00, Name: REG0200

Table 130. Bit Descriptions for REG0200

Bits	Bit Name	Description	Reset	Access
[7:6]	RESERVED	Reserved.	0x0	R
[5:1]	LUT_WR_ADDR	Selects the LUT address to write band, core and n.	0x0	R/W
0	O_VCO_LUT	Enables the override of the LUT calibration.	0x0	R/W

Address: 0x201, Reset: 0x00, Name: REG0201

REGISTER MAP

Table 131. Bit Descriptions for REG0201

Bits	Bit Name	Description	Reset	Access
[7:0]	M_LUT_BAND[7:0]	Selects the LUT_WR_ADDR value of the LUT band when O_VCO_LUT = 1.	0x0	R/W

Address: 0x202, Reset: 0x00, Name: REG0202

Table 132. Bit Descriptions for REG0202

Bits	Bit Name	Description	Reset	Access
[7:2]	M_LUT_N[5:0]	Selects the LUT_WR_ADDR value of the LUT N value when O_VCO_LUT = 1.	0x0	R/W
1	M_LUT_CORE	Selects the LUT_WR_ADDR value of the LUT core when O_VCO_LUT = 1.	0x0	R/W
0	M_LUT_BAND[8]	Selects the LUT_WR_ADDR value of the LUT band when O_VCO_LUT = 1.	0x0	R/W

Address: 0x203, Reset: 0x00, Name: REG0203

Table 133. Bit Descriptions for REG0203

Bits	Bit Name	Description	Reset	Access
[7:6]	RESERVED	Reserved.	0x0	R
[5:0]	M_LUT_N[11:6]	Selects the LUT_WR_ADDR value of the LUT N value when O_VCO_LUT = 1.	0x0	R/W

Address: 0x204, Reset: 0x00, Name: REG0204

Table 134. Bit Descriptions for REG0204

Bits	Bit Name	Description	Reset	Access
[7:0]	LUT_BAND_0[7:0]	Band 0 selected by the LUT.	0x0	R

Address: 0x205, Reset: 0x00, Name: REG0205

Table 135. Bit Descriptions for REG0205

Bits	Bit Name	Description	Reset	Access
[7:2]	RESERVED	Reserved.	0x0	R
1	LUT_CORE[0]	Core selected by the LUT.	0x0	R
0	LUT_BAND_0[8]	Band 0 selected by the LUT.	0x0	R

Address: 0x206, Reset: 0x00, Name: REG0206

Table 136. Bit Descriptions for REG0206

Bits	Bit Name	Description	Reset	Access
[7:0]	LUT_BAND_1[7:0]	Band 1 selected by the LUT.	0x0	R

Address: 0x207, Reset: 0x00, Name: REG0207

Table 137. Bit Descriptions for REG0207

Bits	Bit Name	Description	Reset	Access
[7:2]	RESERVED	Reserved.	0x0	R
1	LUT_CORE[1]	Core selected by the LUT.	0x0	R
0	LUT_BAND_1[8]	Band 1 selected by the LUT.	0x0	R

Address: 0x208, Reset: 0x00, Name: REG0208

REGISTER MAP

Table 138. Bit Descriptions for REG0208

Bits	Bit Name	Description	Reset	Access
[7:0]	LUT_BAND_2[7:0]	Band 2 selected by the LUT.	0x0	R

Address: 0x209, Reset: 0x00, Name: REG0209

Table 139. Bit Descriptions for REG0209

Bits	Bit Name	Description	Reset	Access
[7:2]	RESERVED	Reserved.	0x0	R
1	LUT_CORE[2]	Core selected by the LUT.	0x0	R
0	LUT_BAND_2[8]	Band 2 selected by the LUT.	0x0	R

Address: 0x20A, Reset: 0x00, Name: REG020A

Table 140. Bit Descriptions for REG020A

Bits	Bit Name	Description	Reset	Access
[7:0]	LUT_BAND_3[7:0]	Band 3 selected by the LUT.	0x0	R

Address: 0x20B, Reset: 0x00, Name: REG020B

Table 141. Bit Descriptions for REG020B

Bits	Bit Name	Description	Reset	Access
[7:2]	RESERVED	Reserved.	0x0	R
1	LUT_CORE[3]	Core selected by the LUT.	0x0	R
0	LUT_BAND_3[8]	Band 3 selected by the LUT.	0x0	R

Address: 0x20C, Reset: 0x00, Name: REG020C

Table 142. Bit Descriptions for REG020C

Bits	Bit Name	Description	Reset	Access
[7:0]	LUT_BAND_4[7:0]	Band 4 selected by the LUT.	0x0	R

Address: 0x20D, Reset: 0x00, Name: REG020D

Table 143. Bit Descriptions for REG020D

Bits	Bit Name	Description	Reset	Access
[7:2]	RESERVED	Reserved.	0x0	R
1	LUT_CORE[4]	Core selected by the LUT.	0x0	R
0	LUT_BAND_4[8]	Band 4 selected by the LUT.	0x0	R

Address: 0x20E, Reset: 0x00, Name: REG020E

Table 144. Bit Descriptions for REG020E

Bits	Bit Name	Description	Reset	Access
[7:0]	LUT_BAND_5[7:0]	Band 5 selected by the LUT.	0x0	R

Address: 0x20F, Reset: 0x00, Name: REG020F

REGISTER MAP

Table 145. Bit Descriptions for REG020F

Bits	Bit Name	Description	Reset	Access
[7:2]	RESERVED	Reserved.	0x0	R
1	LUT_CORE[5]	Core selected by the LUT.	0x0	R
0	LUT_BAND_5[8]	Band 5 selected by the LUT.	0x0	R

Address: 0x210, Reset: 0x00, Name: REG0210

Table 146. Bit Descriptions for REG0210

Bits	Bit Name	Description	Reset	Access
[7:0]	LUT_BAND_6[7:0]	Band 6 selected by the LUT.	0x0	R

Address: 0x211, Reset: 0x00, Name: REG0211

Table 147. Bit Descriptions for REG0211

Bits	Bit Name	Description	Reset	Access
[7:2]	RESERVED	Reserved.	0x0	R
1	LUT_CORE[6]	Core selected by the LUT.	0x0	R
0	LUT_BAND_6[8]	Band 6 selected by the LUT.	0x0	R

Address: 0x212, Reset: 0x00, Name: REG0212

Table 148. Bit Descriptions for REG0212

Bits	Bit Name	Description	Reset	Access
[7:0]	LUT_BAND_7[7:0]	Band 7 selected by the LUT.	0x0	R

Address: 0x213, Reset: 0x00, Name: REG0213

Table 149. Bit Descriptions for REG0213

Bits	Bit Name	Description	Reset	Access
[7:2]	RESERVED	Reserved.	0x0	R
1	LUT_CORE[7]	Core selected by the LUT.	0x0	R
0	LUT_BAND_7[8]	Band 7 selected by the LUT.	0x0	R

Address: 0x214, Reset: 0x00, Name: REG0214

Table 150. Bit Descriptions for REG0214

Bits	Bit Name	Description	Reset	Access
[7:0]	LUT_BAND_8[7:0]	Band 8 selected by the LUT.	0x0	R

Address: 0x215, Reset: 0x00, Name: REG0215

Table 151. Bit Descriptions for REG0215

Bits	Bit Name	Description	Reset	Access
[7:2]	RESERVED	Reserved.	0x0	R
1	LUT_CORE[8]	Core selected by the LUT.	0x0	R
0	LUT_BAND_8[8]	Band 8 selected by the LUT.	0x0	R

Address: 0x216, Reset: 0x00, Name: REG0216

REGISTER MAP

Table 152. Bit Descriptions for REG0216

Bits	Bit Name	Description	Reset	Access
[7:0]	LUT_BAND_9[7:0]	Band 9 selected by the LUT.	0x0	R

Address: 0x217, Reset: 0x00, Name: REG0217

Table 153. Bit Descriptions for REG0217

Bits	Bit Name	Description	Reset	Access
[7:2]	RESERVED	Reserved.	0x0	R
1	LUT_CORE[9]	Core selected by the LUT.	0x0	R
0	LUT_BAND_9[8]	Band 9 selected by the LUT.	0x0	R

Address: 0x218, Reset: 0x00, Name: REG0218

Table 154. Bit Descriptions for REG0218

Bits	Bit Name	Description	Reset	Access
[7:0]	LUT_BAND_10[7:0]	Band 10 selected by the LUT.	0x0	R

Address: 0x219, Reset: 0x00, Name: REG0219

Table 155. Bit Descriptions for REG0219

Bits	Bit Name	Description	Reset	Access
[7:2]	RESERVED	Reserved.	0x0	R
1	LUT_CORE[10]	Core selected by the LUT.	0x0	R
0	LUT_BAND_10[8]	Band 10 selected by the LUT.	0x0	R

Address: 0x21A, Reset: 0x00, Name: REG021A

Table 156. Bit Descriptions for REG021A

Bits	Bit Name	Description	Reset	Access
[7:0]	LUT_BAND_11[7:0]	Band 11 selected by the LUT.	0x0	R

Address: 0x21B, Reset: 0x00, Name: REG021B

Table 157. Bit Descriptions for REG021B

Bits	Bit Name	Description	Reset	Access
[7:2]	RESERVED	Reserved.	0x0	R
1	LUT_CORE[11]	Core selected by the LUT.	0x0	R
0	LUT_BAND_11[8]	Band 11 selected by the LUT.	0x0	R

Address: 0x21C, Reset: 0x00, Name: REG021C

Table 158. Bit Descriptions for REG021C

Bits	Bit Name	Description	Reset	Access
[7:0]	LUT_BAND_12[7:0]	Band 12 selected by the LUT.	0x0	R

Address: 0x21D, Reset: 0x00, Name: REG021D

REGISTER MAP

Table 159. Bit Descriptions for REG021D

Bits	Bit Name	Description	Reset	Access
[7:2]	RESERVED	Reserved.	0x0	R
1	LUT_CORE[12]	Core selected by the LUT.	0x0	R
0	LUT_BAND_12[8]	Band 12 selected by the LUT.	0x0	R

Address: 0x21E, Reset: 0x00, Name: REG021E

Table 160. Bit Descriptions for REG021E

Bits	Bit Name	Description	Reset	Access
[7:0]	LUT_BAND_13[7:0]	Band 13 selected by the LUT.	0x0	R

Address: 0x21F, Reset: 0x00, Name: REG021F

Table 161. Bit Descriptions for REG021F

Bits	Bit Name	Description	Reset	Access
[7:2]	RESERVED	Reserved.	0x0	R
1	LUT_CORE[13]	Core selected by the LUT.	0x0	R
0	LUT_BAND_13[8]	Band 13 selected by the LUT.	0x0	R

Address: 0x220, Reset: 0x00, Name: REG0220

Table 162. Bit Descriptions for REG0220

Bits	Bit Name	Description	Reset	Access
[7:0]	LUT_BAND_14[7:0]	Band 14 selected by the LUT.	0x0	R

Address: 0x221, Reset: 0x00, Name: REG0221

Table 163. Bit Descriptions for REG0221

Bits	Bit Name	Description	Reset	Access
[7:2]	RESERVED	Reserved.	0x0	R
1	LUT_CORE[14]	Core selected by the LUT.	0x0	R
0	LUT_BAND_14[8]	Band 14 selected by the LUT.	0x0	R

Address: 0x222, Reset: 0x00, Name: REG0222

Table 164. Bit Descriptions for REG0222

Bits	Bit Name	Description	Reset	Access
[7:0]	LUT_BAND_15[7:0]	Band 15 selected by the LUT.	0x0	R

Address: 0x223, Reset: 0x00, Name: REG0223

Table 165. Bit Descriptions for REG0223

Bits	Bit Name	Description	Reset	Access
[7:2]	RESERVED	Reserved.	0x0	R
1	LUT_CORE[15]	Core selected by the LUT.	0x0	R
0	LUT_BAND_15[8]	Band 15 selected by the LUT.	0x0	R

Address: 0x224, Reset: 0x00, Name: REG0224

REGISTER MAP

Table 166. Bit Descriptions for REG0224

Bits	Bit Name	Description	Reset	Access
[7:0]	LUT_BAND_16[7:0]	Band 16 selected by the LUT.	0x0	R

Address: 0x225, Reset: 0x00, Name: REG0225

Table 167. Bit Descriptions for REG0225

Bits	Bit Name	Description	Reset	Access
[7:2]	RESERVED	Reserved.	0x0	R
1	LUT_CORE[16]	Core selected by the LUT.	0x0	R
0	LUT_BAND_16[8]	Band 16 selected by the LUT.	0x0	R

Address: 0x226, Reset: 0x00, Name: REG0226

Table 168. Bit Descriptions for REG0226

Bits	Bit Name	Description	Reset	Access
[7:0]	LUT_BAND_17[7:0]	Band 17 selected by the LUT.	0x0	R

Address: 0x227, Reset: 0x00, Name: REG0227

Table 169. Bit Descriptions for REG0227

Bits	Bit Name	Description	Reset	Access
[7:2]	RESERVED	Reserved.	0x0	R
1	LUT_CORE[17]	Core selected by the LUT.	0x0	R
0	LUT_BAND_17[8]	Band 17 selected by the LUT.	0x0	R

Address: 0x228, Reset: 0x00, Name: REG0228

Table 170. Bit Descriptions for REG0228

Bits	Bit Name	Description	Reset	Access
[7:0]	LUT_BAND_18[7:0]	Band 18 selected by the LUT.	0x0	R

Address: 0x229, Reset: 0x00, Name: REG0229

Table 171. Bit Descriptions for REG0229

Bits	Bit Name	Description	Reset	Access
[7:2]	RESERVED	Reserved.	0x0	R
1	LUT_CORE[18]	Core selected by the LUT.	0x0	R
0	LUT_BAND_18[8]	Band 18 selected by the LUT.	0x0	R

Address: 0x22A, Reset: 0x00, Name: REG022A

Table 172. Bit Descriptions for REG022A

Bits	Bit Name	Description	Reset	Access
[7:0]	LUT_BAND_19[7:0]	Band 19 selected by the LUT.	0x0	R

Address: 0x22B, Reset: 0x00, Name: REG022B

REGISTER MAP

Table 173. Bit Descriptions for REG022B

Bits	Bit Name	Description	Reset	Access
[7:2]	RESERVED	Reserved.	0x0	R
1	LUT_CORE[19]	Core selected by the LUT.	0x0	R
0	LUT_BAND_19[8]	Band 19 selected by the LUT.	0x0	R

Address: 0x22C, Reset: 0x00, Name: REG022C

Table 174. Bit Descriptions for REG022C

Bits	Bit Name	Description	Reset	Access
[7:0]	LUT_BAND_20[7:0]	Band 20 selected by the LUT.	0x0	R

Address: 0x22D, Reset: 0x00, Name: REG022D

Table 175. Bit Descriptions for REG022D

Bits	Bit Name	Description	Reset	Access
[7:2]	RESERVED	Reserved.	0x0	R
1	LUT_CORE[20]	Core selected by the LUT.	0x0	R
0	LUT_BAND_20[8]	Band 20 selected by the LUT.	0x0	R

Address: 0x22E, Reset: 0x00, Name: REG022E

Table 176. Bit Descriptions for REG022E

Bits	Bit Name	Description	Reset	Access
[7:0]	LUT_BAND_21[7:0]	Band 21 selected by the LUT.	0x0	R

Address: 0x22F, Reset: 0x00, Name: REG022F

Table 177. Bit Descriptions for REG022F

Bits	Bit Name	Description	Reset	Access
[7:2]	RESERVED	Reserved.	0x0	R
1	LUT_CORE[21]	Core selected by the LUT.	0x0	R
0	LUT_BAND_21[8]	Band 21 selected by the LUT.	0x0	R

Address: 0x230, Reset: 0x00, Name: REG0230

Table 178. Bit Descriptions for REG0230

Bits	Bit Name	Description	Reset	Access
[7:0]	LUT_BAND_22[7:0]	Band 22 selected by the LUT.	0x0	R

Address: 0x231, Reset: 0x00, Name: REG0231

Table 179. Bit Descriptions for REG0231

Bits	Bit Name	Description	Reset	Access
[7:2]	RESERVED	Reserved.	0x0	R
1	LUT_CORE[22]	Core selected by the LUT.	0x0	R
0	LUT_BAND_22[8]	Band 22 selected by the LUT.	0x0	R

Address: 0x232, Reset: 0x00, Name: REG0232

REGISTER MAP

Table 180. Bit Descriptions for REG0232

Bits	Bit Name	Description	Reset	Access
[7:0]	LUT_BAND_23[7:0]	Band 23 selected by the LUT.	0x0	R

Address: 0x233, Reset: 0x00, Name: REG0233

Table 181. Bit Descriptions for REG0233

Bits	Bit Name	Description	Reset	Access
[7:2]	RESERVED	Reserved.	0x0	R
1	LUT_CORE[23]	Core selected by the LUT.	0x0	R
0	LUT_BAND_23[8]	Band 23 selected by the LUT.	0x0	R

Address: 0x234, Reset: 0x00, Name: REG0234

Table 182. Bit Descriptions for REG0234

Bits	Bit Name	Description	Reset	Access
[7:0]	LUT_BAND_24[7:0]	Band 24 selected by the LUT.	0x0	R

Address: 0x235, Reset: 0x00, Name: REG0235

Table 183. Bit Descriptions for REG0235

Bits	Bit Name	Description	Reset	Access
[7:2]	RESERVED	Reserved.	0x0	R
1	LUT_CORE[24]	Core selected by the LUT.	0x0	R
0	LUT_BAND_24[8]	Band 24 selected by the LUT.	0x0	R

Address: 0x236, Reset: 0x00, Name: REG0236

Table 184. Bit Descriptions for REG0236

Bits	Bit Name	Description	Reset	Access
[7:0]	LUT_BAND_25[7:0]	Band 25 selected by the LUT.	0x0	R

Address: 0x237, Reset: 0x00, Name: REG0237

Table 185. Bit Descriptions for REG0237

Bits	Bit Name	Description	Reset	Access
[7:2]	RESERVED	Reserved.	0x0	R
1	LUT_CORE[25]	Core selected by the LUT.	0x0	R
0	LUT_BAND_25[8]	Band 25 selected by the LUT.	0x0	R

Address: 0x238, Reset: 0x00, Name: REG0238

Table 186. Bit Descriptions for REG0238

Bits	Bit Name	Description	Reset	Access
[7:0]	LUT_BAND_26[7:0]	Band 26 selected by the LUT.	0x0	R

Address: 0x239, Reset: 0x00, Name: REG0239

REGISTER MAP

Table 187. Bit Descriptions for REG0239

Bits	Bit Name	Description	Reset	Access
[7:2]	RESERVED	Reserved.	0x0	R
1	LUT_CORE[26]	Core selected by the LUT.	0x0	R
0	LUT_BAND_26[8]	Band 26 selected by the LUT.	0x0	R

Address: 0x23A, Reset: 0x00, Name: REG023A

Table 188. Bit Descriptions for REG023A

Bits	Bit Name	Description	Reset	Access
[7:0]	LUT_BAND_27[7:0]	Band 27 selected by the LUT.	0x0	R

Address: 0x23B, Reset: 0x00, Name: REG023B

Table 189. Bit Descriptions for REG023B

Bits	Bit Name	Description	Reset	Access
[7:2]	RESERVED	Reserved.	0x0	R
1	LUT_CORE[27]	Core selected by the LUT.	0x0	R
0	LUT_BAND_27[8]	Band 27 selected by the LUT.	0x0	R

Address: 0x23C, Reset: 0x00, Name: REG023C

Table 190. Bit Descriptions for REG023C

Bits	Bit Name	Description	Reset	Access
[7:0]	LUT_BAND_28[7:0]	Band 28 selected by the LUT.	0x0	R

Address: 0x23D, Reset: 0x00, Name: REG023D

Table 191. Bit Descriptions for REG023D

Bits	Bit Name	Description	Reset	Access
[7:2]	RESERVED	Reserved.	0x0	R
1	LUT_CORE[28]	Core selected by the LUT.	0x0	R
0	LUT_BAND_28[8]	Band 28 selected by the LUT.	0x0	R

Address: 0x23E, Reset: 0x00, Name: REG023E

Table 192. Bit Descriptions for REG023E

Bits	Bit Name	Description	Reset	Access
[7:0]	LUT_BAND_29[7:0]	Band 29 selected by the LUT.	0x0	R

Address: 0x23F, Reset: 0x00, Name: REG023F

Table 193. Bit Descriptions for REG023F

Bits	Bit Name	Description	Reset	Access
[7:2]	RESERVED	Reserved.	0x0	R
1	LUT_CORE[29]	Core selected by the LUT.	0x0	R
0	LUT_BAND_29[8]	Band 29 selected by the LUT.	0x0	R

Address: 0x240, Reset: 0x00, Name: REG0240

REGISTER MAP

Table 194. Bit Descriptions for REG0240

Bits	Bit Name	Description	Reset	Access
[7:0]	LUT_BAND_30[7:0]	Band 30 selected by the LUT.	0x0	R

Address: 0x241, Reset: 0x00, Name: REG0241

Table 195. Bit Descriptions for REG0241

Bits	Bit Name	Description	Reset	Access
[7:2]	RESERVED	Reserved.	0x0	R
1	LUT_CORE[30]	Core selected by the LUT.	0x0	R
0	LUT_BAND_30[8]	Band 30 selected by the LUT.	0x0	R

Address: 0x242, Reset: 0x00, Name: REG0242

Table 196. Bit Descriptions for REG0242

Bits	Bit Name	Description	Reset	Access
[7:0]	LUT_BAND_31[7:0]	Band 31 selected by the LUT.	0x0	R

Address: 0x243, Reset: 0x00, Name: REG0243

Table 197. Bit Descriptions for REG0243

Bits	Bit Name	Description	Reset	Access
[7:2]	RESERVED	Reserved.	0x0	R
1	LUT_CORE[31]	Core selected by the LUT.	0x0	R
0	LUT_BAND_31[8]	Band 31 selected by the LUT.	0x0	R

Address: 0x244, Reset: 0x00, Name: REG0244

Table 198. Bit Descriptions for REG0244

Bits	Bit Name	Description	Reset	Access
[7:0]	LUT_N_0[7:0]	N Threshold 0 selected by the LUT.	0x0	R

Address: 0x245, Reset: 0x00, Name: REG0245

Table 199. Bit Descriptions for REG0245

Bits	Bit Name	Description	Reset	Access
[7:4]	LUT_N_1[3:0]	N Threshold 1 selected by the LUT.	0x0	R
[3:0]	LUT_N_0[11:8]	N Threshold 0 selected by the LUT.	0x0	R

Address: 0x246, Reset: 0x00, Name: REG0246

Table 200. Bit Descriptions for REG0246

Bits	Bit Name	Description	Reset	Access
[7:0]	LUT_N_1[11:4]	N Threshold 1 selected by the LUT.	0x0	R

Address: 0x247, Reset: 0x00, Name: REG0247

Table 201. Bit Descriptions for REG0247

Bits	Bit Name	Description	Reset	Access
[7:0]	LUT_N_2[7:0]	N Threshold 2 selected by the LUT.	0x0	R

REGISTER MAP

Address: 0x248, Reset: 0x00, Name: REG0248

Table 202. Bit Descriptions for REG0248

Bits	Bit Name	Description	Reset	Access
[7:4]	LUT_N_3[3:0]	N Threshold 3 selected by the LUT.	0x0	R
[3:0]	LUT_N_2[11:8]	N Threshold 2 selected by the LUT.	0x0	R

Address: 0x249, Reset: 0x00, Name: REG0249

Table 203. Bit Descriptions for REG0249

Bits	Bit Name	Description	Reset	Access
[7:0]	LUT_N_3[11:4]	N Threshold 3 selected by the LUT.	0x0	R

Address: 0x24A, Reset: 0x00, Name: REG024A

Table 204. Bit Descriptions for REG024A

Bits	Bit Name	Description	Reset	Access
[7:0]	LUT_N_4[7:0]	N Threshold 4 selected by the LUT.	0x0	R

Address: 0x24B, Reset: 0x00, Name: REG024B

Table 205. Bit Descriptions for REG024B

Bits	Bit Name	Description	Reset	Access
[7:4]	LUT_N_5[3:0]	N Threshold 5 selected by the LUT.	0x0	R
[3:0]	LUT_N_4[11:8]	N Threshold 4 selected by the LUT.	0x0	R

Address: 0x24C, Reset: 0x00, Name: REG024C

Table 206. Bit Descriptions for REG024C

Bits	Bit Name	Description	Reset	Access
[7:0]	LUT_N_5[11:4]	N Threshold 5 selected by the LUT.	0x0	R

Address: 0x24D, Reset: 0x00, Name: REG024D

Table 207. Bit Descriptions for REG024D

Bits	Bit Name	Description	Reset	Access
[7:0]	LUT_N_6[7:0]	N Threshold 6 selected by the LUT.	0x0	R

Address: 0x24E, Reset: 0x00, Name: REG024E

Table 208. Bit Descriptions for REG024E

Bits	Bit Name	Description	Reset	Access
[7:4]	LUT_N_7[3:0]	N Threshold 7 selected by the LUT.	0x0	R
[3:0]	LUT_N_6[11:8]	N Threshold 6 selected by the LUT.	0x0	R

Address: 0x24F, Reset: 0x00, Name: REG024F

Table 209. Bit Descriptions for REG024F

Bits	Bit Name	Description	Reset	Access
[7:0]	LUT_N_7[11:4]	N Threshold 7 selected by the LUT.	0x0	R

REGISTER MAP

Address: 0x250, Reset: 0x00, Name: REG0250

Table 210. Bit Descriptions for REG0250

Bits	Bit Name	Description	Reset	Access
[7:0]	LUT_N_8[7:0]	N Threshold 8 selected by the LUT.	0x0	R

Address: 0x251, Reset: 0x00, Name: REG0251

Table 211. Bit Descriptions for REG0251

Bits	Bit Name	Description	Reset	Access
[7:4]	LUT_N_9[3:0]	N Threshold 9 selected by the LUT.	0x0	R
[3:0]	LUT_N_8[11:8]	N Threshold 8 selected by the LUT.	0x0	R

Address: 0x252, Reset: 0x00, Name: REG0252

Table 212. Bit Descriptions for REG0252

Bits	Bit Name	Description	Reset	Access
[7:0]	LUT_N_9[11:4]	N Threshold 9 selected by the LUT.	0x0	R

Address: 0x253, Reset: 0x00, Name: REG0253

Table 213. Bit Descriptions for REG0253

Bits	Bit Name	Description	Reset	Access
[7:0]	LUT_N_10[7:0]	N Threshold 10 selected by the LUT.	0x0	R

Address: 0x254, Reset: 0x00, Name: REG0254

Table 214. Bit Descriptions for REG0254

Bits	Bit Name	Description	Reset	Access
[7:4]	LUT_N_11[3:0]	N Threshold 11 selected by the LUT.	0x0	R
[3:0]	LUT_N_10[11:8]	N Threshold 10 selected by the LUT.	0x0	R

Address: 0x255, Reset: 0x00, Name: REG0255

Table 215. Bit Descriptions for REG0255

Bits	Bit Name	Description	Reset	Access
[7:0]	LUT_N_11[11:4]	N Threshold 11 selected by the LUT.	0x0	R

Address: 0x256, Reset: 0x00, Name: REG0256

Table 216. Bit Descriptions for REG0256

Bits	Bit Name	Description	Reset	Access
[7:0]	LUT_N_12[7:0]	N Threshold 12 selected by the LUT.	0x0	R

Address: 0x257, Reset: 0x00, Name: REG0257

Table 217. Bit Descriptions for REG0257

Bits	Bit Name	Description	Reset	Access
[7:4]	LUT_N_13[3:0]	N Threshold 13 selected by the LUT.	0x0	R
[3:0]	LUT_N_12[11:8]	N Threshold 12 selected by the LUT.	0x0	R

REGISTER MAP

Address: 0x258, Reset: 0x00, Name: REG0258

Table 218. Bit Descriptions for REG0258

Bits	Bit Name	Description	Reset	Access
[7:0]	LUT_N_13[11:4]	N Threshold 13 selected by the LUT.	0x0	R

Address: 0x259, Reset: 0x00, Name: REG0259

Table 219. Bit Descriptions for REG0259

Bits	Bit Name	Description	Reset	Access
[7:0]	LUT_N_14[7:0]	N Threshold 14 selected by the LUT.	0x0	R

Address: 0x25A, Reset: 0x00, Name: REG025A

Table 220. Bit Descriptions for REG025A

Bits	Bit Name	Description	Reset	Access
[7:4]	LUT_N_15[3:0]	N Threshold 15 selected by the LUT.	0x0	R
[3:0]	LUT_N_14[11:8]	N Threshold 14 selected by the LUT.	0x0	R

Address: 0x25B, Reset: 0x00, Name: REG025B

Table 221. Bit Descriptions for REG025B

Bits	Bit Name	Description	Reset	Access
[7:0]	LUT_N_15[11:4]	N Threshold 15 selected by the LUT.	0x0	R

Address: 0x25C, Reset: 0x00, Name: REG025C

Table 222. Bit Descriptions for REG025C

Bits	Bit Name	Description	Reset	Access
[7:0]	LUT_N_16[7:0]	N Threshold 16 selected by the LUT.	0x0	R

Address: 0x25D, Reset: 0x00, Name: REG025D

Table 223. Bit Descriptions for REG025D

Bits	Bit Name	Description	Reset	Access
[7:4]	LUT_N_17[3:0]	N Threshold 17 selected by the LUT.	0x0	R
[3:0]	LUT_N_16[11:8]	N Threshold 16 selected by the LUT.	0x0	R

Address: 0x25E, Reset: 0x00, Name: REG025E

Table 224. Bit Descriptions for REG025E

Bits	Bit Name	Description	Reset	Access
[7:0]	LUT_N_17[11:4]	N Threshold 17 selected by the LUT.	0x0	R

Address: 0x25F, Reset: 0x00, Name: REG025F

Table 225. Bit Descriptions for REG025F

Bits	Bit Name	Description	Reset	Access
[7:0]	LUT_N_18[7:0]	N Threshold 18 selected by the LUT.	0x0	R

Address: 0x260, Reset: 0x00, Name: REG0260

REGISTER MAP

Table 226. Bit Descriptions for REG0260

Bits	Bit Name	Description	Reset	Access
[7:4]	LUT_N_19[3:0]	N Threshold 19 selected by the LUT.	0x0	R
[3:0]	LUT_N_18[11:8]	N Threshold 18 selected by the LUT.	0x0	R

Address: 0x261, Reset: 0x00, Name: REG0261

Table 227. Bit Descriptions for REG0261

Bits	Bit Name	Description	Reset	Access
[7:0]	LUT_N_19[11:4]	N Threshold 19 selected by the LUT.	0x0	R

Address: 0x262, Reset: 0x00, Name: REG0262

Table 228. Bit Descriptions for REG0262

Bits	Bit Name	Description	Reset	Access
[7:0]	LUT_N_20[7:0]	N Threshold 20 selected by the LUT.	0x0	R

Address: 0x263, Reset: 0x00, Name: REG0263

Table 229. Bit Descriptions for REG0263

Bits	Bit Name	Description	Reset	Access
[7:4]	LUT_N_21[3:0]	N Threshold 21 selected by the LUT.	0x0	R
[3:0]	LUT_N_20[11:8]	N Threshold 20 selected by the LUT.	0x0	R

Address: 0x264, Reset: 0x00, Name: REG0264

Table 230. Bit Descriptions for REG0264

Bits	Bit Name	Description	Reset	Access
[7:0]	LUT_N_21[11:4]	N Threshold 21 selected by the LUT.	0x0	R

Address: 0x265, Reset: 0x00, Name: REG0265

Table 231. Bit Descriptions for REG0265

Bits	Bit Name	Description	Reset	Access
[7:0]	LUT_N_22[7:0]	N Threshold 22 selected by the LUT.	0x0	R

Address: 0x266, Reset: 0x00, Name: REG0266

Table 232. Bit Descriptions for REG0266

Bits	Bit Name	Description	Reset	Access
[7:4]	LUT_N_23[3:0]	N Threshold 23 selected by the LUT.	0x0	R
[3:0]	LUT_N_22[11:8]	N Threshold 22 selected by the LUT.	0x0	R

Address: 0x267, Reset: 0x00, Name: REG0267

Table 233. Bit Descriptions for REG0267

Bits	Bit Name	Description	Reset	Access
[7:0]	LUT_N_23[11:4]	N Threshold 23 selected by the LUT.	0x0	R

Address: 0x268, Reset: 0x00, Name: REG0268

REGISTER MAP

Table 234. Bit Descriptions for REG0268

Bits	Bit Name	Description	Reset	Access
[7:0]	LUT_N_24[7:0]	N Threshold 24 selected by the LUT.	0x0	R

Address: 0x269, Reset: 0x00, Name: REG0269

Table 235. Bit Descriptions for REG0269

Bits	Bit Name	Description	Reset	Access
[7:4]	LUT_N_25[3:0]	N Threshold 25 selected by the LUT.	0x0	R
[3:0]	LUT_N_24[11:8]	N Threshold 24 selected by the LUT.	0x0	R

Address: 0x26A, Reset: 0x00, Name: REG026A

Table 236. Bit Descriptions for REG026A

Bits	Bit Name	Description	Reset	Access
[7:0]	LUT_N_25[11:4]	N Threshold 25 selected by the LUT.	0x0	R

Address: 0x26B, Reset: 0x00, Name: REG026B

Table 237. Bit Descriptions for REG026B

Bits	Bit Name	Description	Reset	Access
[7:0]	LUT_N_26[7:0]	N Threshold 26 selected by the LUT.	0x0	R

Address: 0x26C, Reset: 0x00, Name: REG026C

Table 238. Bit Descriptions for REG026C

Bits	Bit Name	Description	Reset	Access
[7:4]	LUT_N_27[3:0]	N Threshold 27 selected by the LUT.	0x0	R
[3:0]	LUT_N_26[11:8]	N Threshold 26 selected by the LUT.	0x0	R

Address: 0x26D, Reset: 0x00, Name: REG026D

Table 239. Bit Descriptions for REG026D

Bits	Bit Name	Description	Reset	Access
[7:0]	LUT_N_27[11:4]	N Threshold 27 selected by the LUT.	0x0	R

Address: 0x26E, Reset: 0x00, Name: REG026E

Table 240. Bit Descriptions for REG026E

Bits	Bit Name	Description	Reset	Access
[7:0]	LUT_N_28[7:0]	N Threshold 28 selected by the LUT.	0x0	R

Address: 0x26F, Reset: 0x00, Name: REG026F

Table 241. Bit Descriptions for REG026F

Bits	Bit Name	Description	Reset	Access
[7:4]	LUT_N_29[3:0]	N Threshold 29 selected by the LUT.	0x0	R
[3:0]	LUT_N_28[11:8]	N Threshold 28 selected by the LUT.	0x0	R

Address: 0x270, Reset: 0x00, Name: REG0270

REGISTER MAP

Table 242. Bit Descriptions for REG0270

Bits	Bit Name	Description	Reset	Access
[7:0]	LUT_N_29[11:4]	N Threshold 29 selected by the LUT.	0x0	R

Address: 0x271, Reset: 0x00, Name: REG0271

Table 243. Bit Descriptions for REG0271

Bits	Bit Name	Description	Reset	Access
[7:0]	LUT_N_30[7:0]	N Threshold 30 selected by the LUT.	0x0	R

Address: 0x272, Reset: 0x00, Name: REG0272

Table 244. Bit Descriptions for REG0272

Bits	Bit Name	Description	Reset	Access
[7:4]	LUT_N_31[3:0]	N Threshold 31 selected by the LUT.	0x0	R
[3:0]	LUT_N_30[11:8]	N Threshold 30 selected by the LUT.	0x0	R

Address: 0x273, Reset: 0x00, Name: REG0273

Table 245. Bit Descriptions for REG0273

Bits	Bit Name	Description	Reset	Access
[7:0]	LUT_N_31[11:4]	N Threshold 31 selected by the LUT.	0x0	R

OUTLINE DIMENSIONS

Package Drawing (Option)	Package Type	Package Description
CC-48-10	LGA	48-Terminal Land Grid Array Package

For the latest package outline information and land patterns (footprints), go to [Package Index](#).

Updated: February 21, 2024

ORDERING GUIDE

Model ¹	Temperature Range	Package Description	Packing Quantity	Package Option
ADF4383BCCZ	-40°C to +105°C	48-Terminal Land Grid Array Package [LGA]	Tray, 260	CC-48-10
ADF4383BCCZ-RL7	-40°C to +105°C	48-Terminal Land Grid Array Package [LGA]	Reel, 500	CC-48-10

¹ Z = RoHS Compliant Part.

EVALUATION BOARDS

Model ¹	Description
EV-ADF4383SD1Z	Evaluation Board

¹ Z = RoHS Compliant Part.