



MAX2424/MAX2426 Evaluation Kits

General Description

The MAX2424/MAX2426 evaluation kits (EV kits) simplify evaluation of the MAX2424/MAX2426 900MHz image-reject transceiver.

The EV kits provide 50Ω SMA connectors for all RF inputs and outputs. A varactor-based tank circuit is provided for the MAX2424/MAX2426 VCO and can be tuned by a potentiometer or external voltage. The VCO can be overdriven by an external source, if desired. (See external LO input under *Adjustments and Control* section).

Switches are provided to control power-management features.

Features

- ◆ 50Ω SMA Ports for Testing Transmit and Receive Paths
- ◆ SMA Port for Prescaler Output
- ◆ Switches Included to Control Power-Management Features
- ◆ VCO Frequency and Receiver Adjustable via On-Board Potentiometers or External Inputs
- ◆ Fully Assembled and Tested

Ordering Information

PART	TEMP. RANGE	IC PACKAGE
MAX2424EVKIT	-40°C to +85°C	28 SSOP
MAX2426EVKIT	-40°C to +85°C	28 SSOP

Component List

DESIGNATION	QTY	DESCRIPTION
C1, C4, C5, C7, C9, C10, C12, C15, C19, C22–C24, C28, C32	14	47pF ceramic capacitors
C2, C3	2	3.3pF ceramic capacitors (0603) (MAX2424) 8.0pF ceramic capacitors (0603) (MAX2426)
C6, C14	2	0.1μF ceramic capacitors
C8, C11, C13, C29, C30, C31	6	0.01μF ceramic capacitors
C16	1	1000pF ceramic capacitor
C17, C18	2	10μF, ±10%, 10V tantalum capacitors AVX TAJB106K010 or Sprague 2930106X90010B
C26	1	2.0pF ceramic capacitor (0603) (MAX2424) 4.0pF ceramic capacitor (0603) (MAX2426)
C27, C33	0	Not installed
D1	1	Dual-varactor diode Alpha SMV1299-004
L1	7	22nH inductor Coilcraft 0805CS-220XMBC
L2	1	8.2nH inductor Coilcraft 0805CS-080XMBC

DESIGNATION	QTY	DESCRIPTION
L3	1	6.8nH, 5% inductor (MAX2424) Coilcraft 0805HS-060TJBC 3.3nH, 5% inductor (MAX2426) Coilcraft 0805HS-030TJBC
L4	1	100nH inductor Coilcraft 0805CS-101XKBC
L5, L7	0	Not installed
L6	1	12nH inductor Coilcraft 0805CS-120XMBC
L8	1	18nH inductor Coilcraft 0805CS-180XMBC
L9	1	82nH inductor Coilcraft 0805CS-820XKBC
R2, R3	2	10kΩ potentiometers
R4, R5	2	1kΩ, 5% resistors
R6, R7	2	10Ω, 5% resistors (0402) (MAX2424) 20Ω, 5% resistors (0402) (MAX2426)
R8	1	47kΩ, 5% resistor
R9, R14–R17	5	10kΩ, 5% resistors
R11, R21	2	Not installed
R10, R13	2	10kΩ, 5% resistors
R12	1	301Ω, 1% resistor
R18, R20	2	49.9Ω, 1% resistors
R19	1	0Ω resistor

Component List continues on next page.

Note: All resistors and capacitors have a 0805 footprint, unless otherwise noted.



MAX2424/MAX2426 Evaluation Kits

Component List (continued)

DESIGNATION	QTY	DESCRIPTION
JU2, JU4, JU7, JU8	4	Shunts
LNAGAIN, VCOADJ	2	1-pin headers
JU2, JU4, JU7, JU8, GND, VEXT, BPSK, DGND	7	2-pin headers
RXIN, RXOUT, TXOUT, TXIN, PREOUT, EXT LO INPUT	6	SMA connectors (PC edge mount)
SW1	1	5-position dip switch
U1	1	MAX2424EAI 28-pin SSOP
		MAX2426EAI 28-pin SSOP

Component Suppliers

SUPPLIER*	PHONE	FAX
Alpha Industries	(617) 935-5150	(617) 933-2359
AVX	(803) 946-0690	(803) 626-3123
Coilcraft	(847) 639-6400	(847) 639-1469
Sprague	(603) 224-1961	(603) 224-1430

*Please indicate that you are using the MAX2424/MAX2426 when contacting these suppliers.

Quick Start

The MAX2424/MAX2426 EV kits are fully assembled and factory tested. **Do not turn on the DC power and signal sources until all connections are made.** The following discussion is based on the MAX2424 with a receive IF frequency of 10.7MHz, high-side LO injection and 1MHz transmit input with a 915MHz LO frequency.

Test Equipment Required

- RF-signal generator capable of generating frequencies up to 1GHz
- Spectrum analyzer with frequency range at least to 3GHz, such as the HP8561
- Two power supplies capable of up to +5.5V output at 100mA

Connections and Signal Conditions

- 1) Verify that all shunts are installed across jumpers JU2, JU4, JU7, and JU8.
- 2) Verify that switch positions 1 through 5 on SW1 are set at the "logic 0" position.
- 3) Set a power supply to 3.3V and set the current limit to 100mA.
- 4) Connect the power supply to the VEXT and GND terminals on the EV kit.
- 5) Set a power supply to 2.3V and set the current limit to 100mA.
- 6) Connect the power supply to the BPSK and GND terminals on the EV kit.
- 7) For testing the receive path, set the signal source frequency to 915MHz (RF) and the power level to -35dBm. For testing the transmit path, set the signal source frequency to 1MHz and the signal level to 250mVp-p. Note that TXIN is terminated with a 50Ω load.

Analysis

- 1) Turn on the on-chip oscillator by setting switch VCOON to "logic 1." To observe the VCO frequency, set switch DIV 1 to "logic 1" (disabling the prescaler and enabling the buffer amplifier) and connect an SMA cable from the spectrum analyzer to the PREOUT port. Set the VCO frequency to 925.7MHz by adjusting VCOADJ (R3).
- 2) The receive conversion gain can be evaluated by setting switch RXON to "logic 1," applying a 915MHz signal to the RXIN port, and observing the RXOUT port at 10.7MHz with the spectrum analyzer. The gain of the LNA in the receiver path can be adjusted by varying R2.

Note: R12 and R18 are used as a resistive matching network to present an optimum 330Ω impedance to the RXOUT pin. This network results in a 14.2dB loss in the receiver path. Therefore, 14.2dB must be added to the power level observed on the spectrum analyzer to obtain the true receive output power. For example, with LNAGAIN set at VCC and the receive input level set at -35dBm, the receive output observed on the spectrum analyzer is approximately -27.2dBm. The true receive conversion gain is $-27.2 - (-35) + 14.2 = 22\text{dB}$.

If desired, pads for C8, R18, C30, R12, L5, and C20 can be used to build a custom reactive-matching network.

MAX2424/MAX2426 Evaluation Kits

- 3) Receive image rejection can be evaluated by changing the receive input frequency to 936.4MHz (while keeping the LO at 925.7MHz) and comparing the output signal level against the one measured in step 2.
- 4) Before evaluating the transmitter, ensure that the receiver is disabled by setting switch RXON to “logic 0.” Set the VCO frequency to 915MHz by adjusting VCOADJ (R3). The transmit output power can be evaluated by setting switch TXON to “logic 1,” applying a 1MHz signal at 250mVp-p to the TXIN port, and observing the TXOUT spectrum at 914MHz and 916MHz with a spectrum analyzer.

Adjustments and Control

VCOADJ

The VCO frequency can be tuned by adjusting on-board potentiometer R3. It can also be tuned by first removing the shunt from jumper JU7 and then applying an external voltage via the VCOADJ terminal. The supply providing the external voltage must be properly bypassed to minimize noise added to the LO.

LNAGAIN

The LNA gain can be adjusted using on-board potentiometer R2. LNA gain control can also be accomplished by first removing the shunt from jumper JU2 and then applying an external voltage via the LNA GAIN terminal.

RXON and TXON

The receive and transmit sections are enabled by setting switches RXON and TXON to “logic 1,” respectively. Interference will result if both sections are active at the same time. When testing either the receive or transmit section, always disable the other section.

To disable all chip functions, set all switches to “logic 0.” To obtain an accurate reading of the device shutdown current, remove the shunt from JU4 and move the V_{CC} connection from the VEXT terminal to the left side of JU4.

Prescaler Control

The function of PREOUT is controlled by the switches labeled “DIV1” and “64” (Table 1).

EXT LO Input

An external LO input may be applied by making the following board changes: Remove R6, R7, L3, L4, C2, C3, and C26. Add two 47pF in place of C27 and C33. Add three 49.9Ω (0402) resistors in place of R6, R7, and R21. Add three shorts in place of R11, L3, and L4. Apply the LO signal at 0dBm to EXTLO INPUT.

Layout Considerations

The MAX2424/MAX2426 EV boards can serve as a guide for your board layout. Take care in laying out the oscillator tank circuit. Oscillation frequency is sensitive to parasitic PC board capacitance, trace inductance, and package inductance. Keep the tank layout as symmetrical, tightly packed, and close to the device as possible to minimize LO feedthrough. When using a PC board with a ground plane, a cutout in the ground plane below the oscillator tank reduces parasitic capacitance. Also, keep traces carrying the receive and transmit signals as short as possible to minimize radiation and insertion loss due to the PC board.

Table 1. PREOUT Function Control Switches

PREOUT FUNCTION	SWITCH “SW1” POSITIONS	
	DIV1	64
LO buffered output	Logic 1	Don't care
Prescaler, ÷64	Logic 0	Logic 1
Prescaler, ÷65	Logic 0	Logic 0

MAX2424/MAX2426 Evaluation Kits

Evaluate: MAX2424/MAX2426

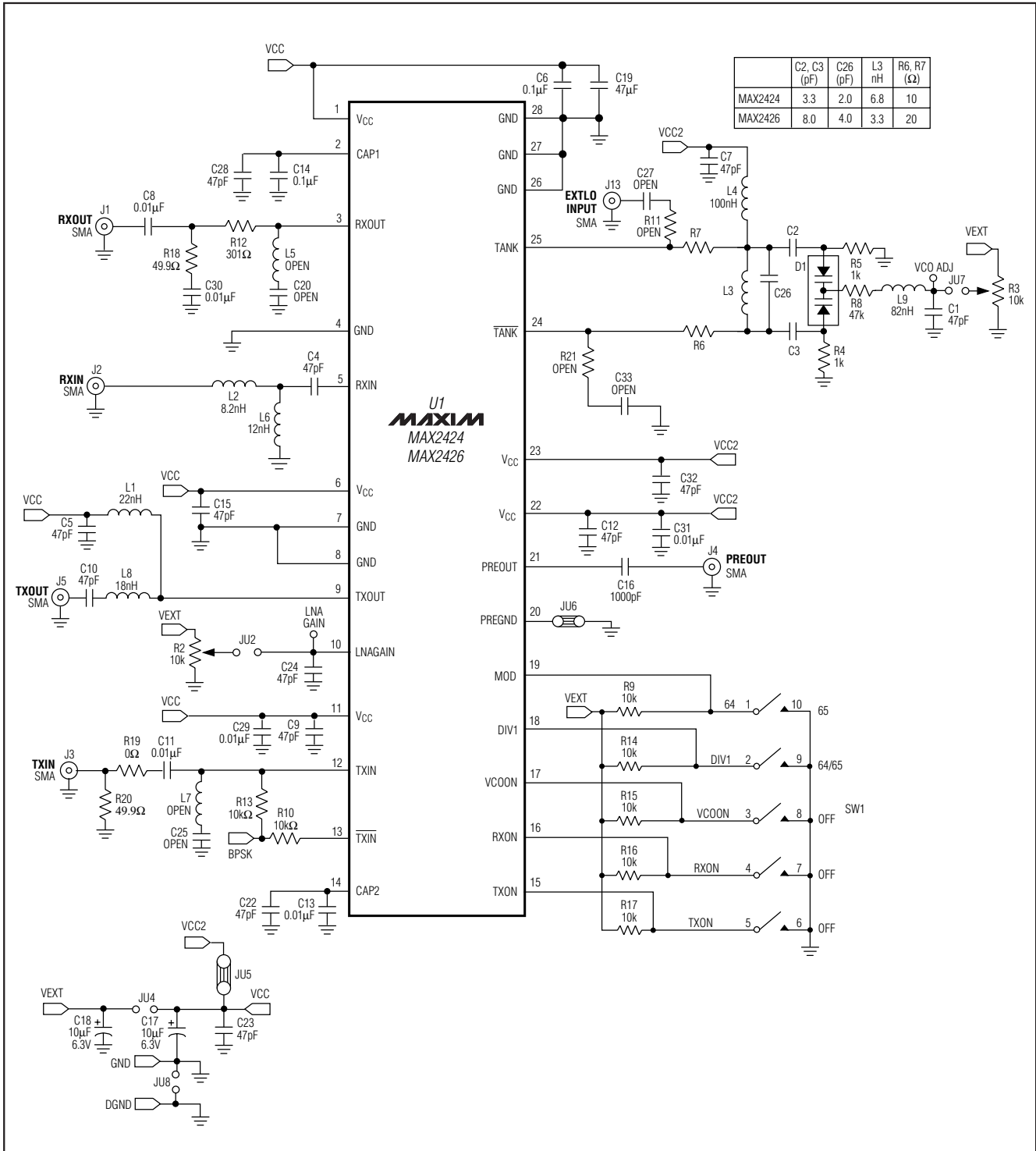

Figure 1. MAX2424/MAX2426 EV Kits Schematic

MAX2424/MAX2426 Evaluation Kits

Evaluate: MAX2424/MAX2426

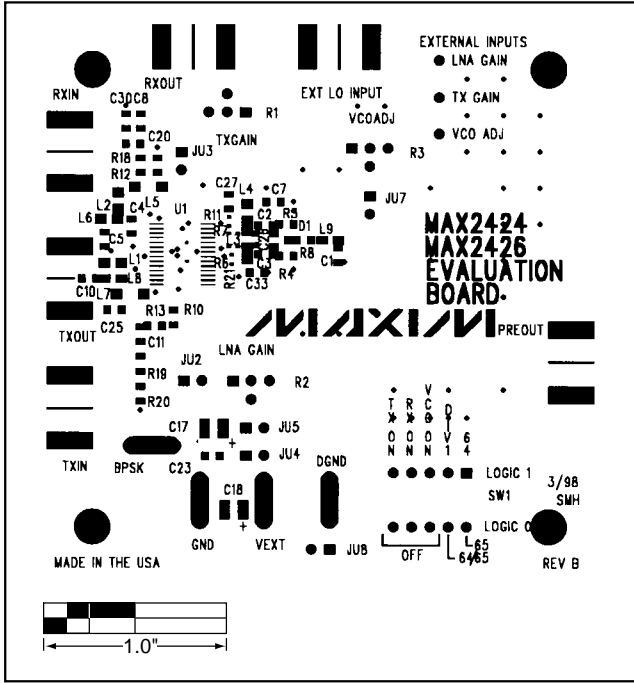

Figure 2. MAX2424/MAX2426 EV Kits Component Placement Guide—Component Side

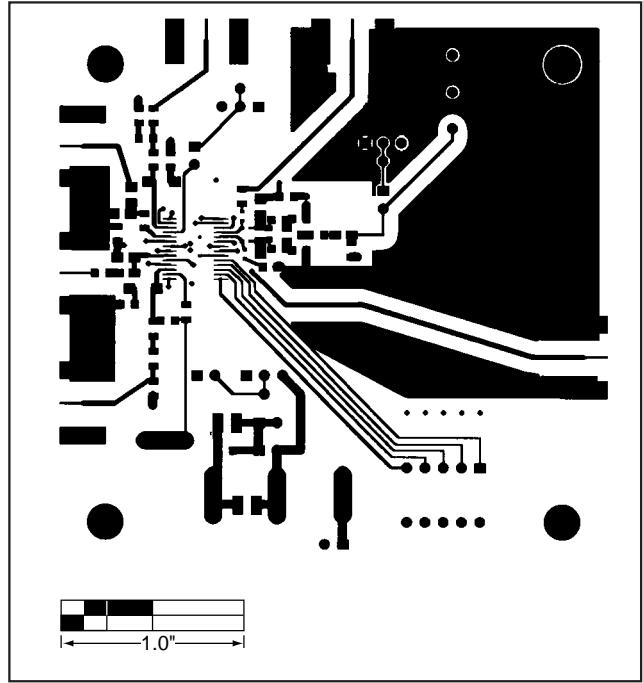

Figure 3. MAX2424/MAX2426 EV Kits PC Board Layout—Component Side

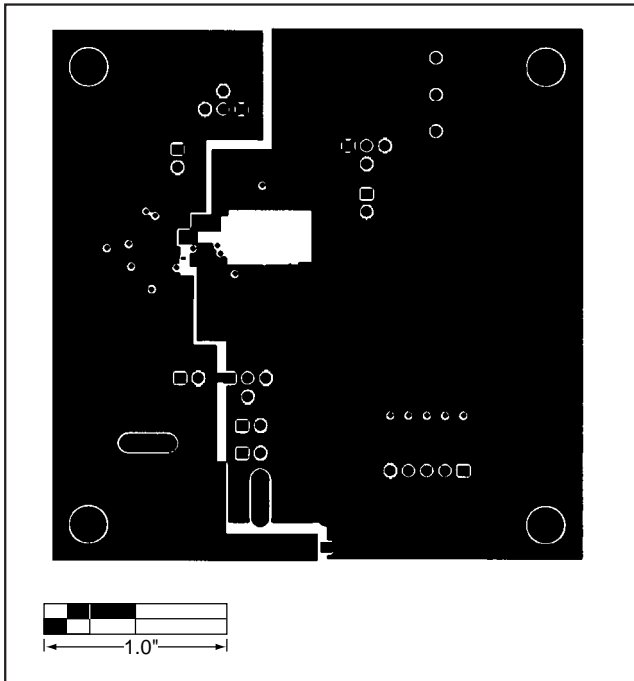

Figure 4. MAX2424/MAX2426 EV Kits PC Board Layout—Ground Plane

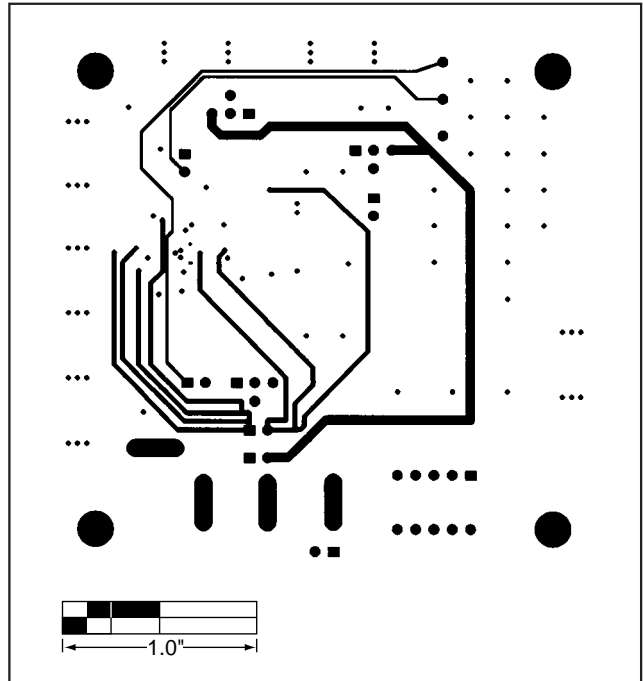

Figure 5. MAX2424/MAX2426 EV Kits PC Board Layout—Power Plane

MAX2424/MAX2426 Evaluation Kits

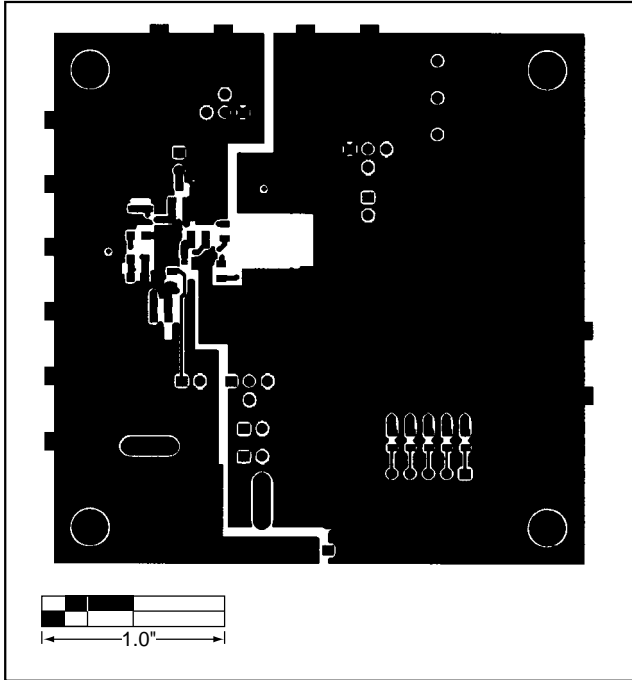

Figure 6. MAX2424/MAX2426 EV Kits PC Board Layout—Solder Side

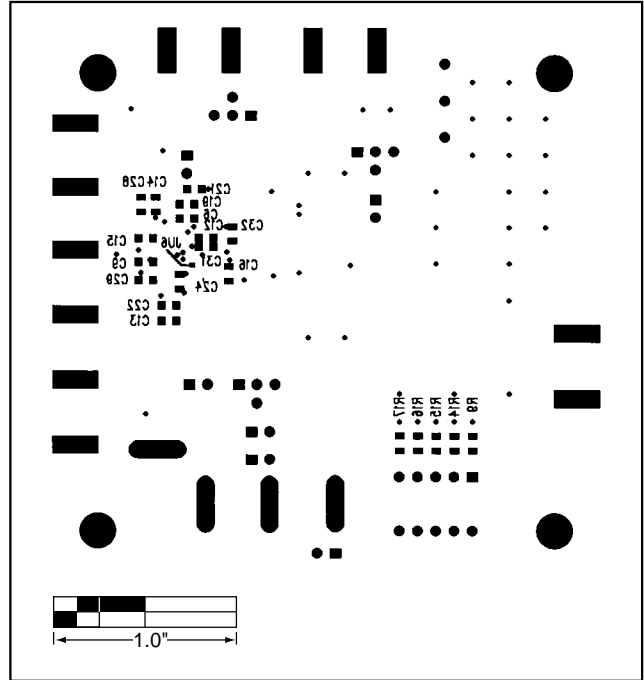

Figure 7. MAX2424/MAX2426 EV Kits PC Board Layout—Bottom Silkscreen

Maxim cannot assume responsibility for use of any circuitry other than circuitry entirely embodied in a Maxim product. No circuit patent licenses are implied. Maxim reserves the right to change the circuitry and specifications without notice at any time.

6 **Maxim Integrated Products, 120 San Gabriel Drive, Sunnyvale, CA 94086 408-737-7600**