

CANopen Firmware Version V3.20

CANopen MANUAL

+

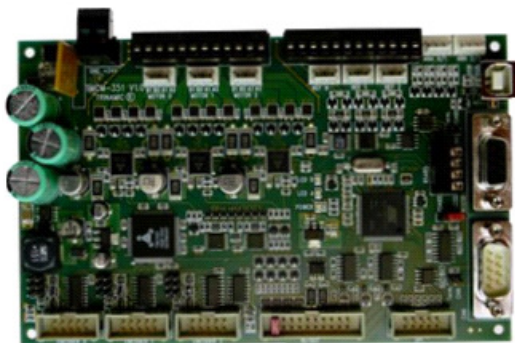

+

CANopen

TMCM-351

3-axis stepper
controller/driver board
2.8A RMS / 24V DC
Encoder interface

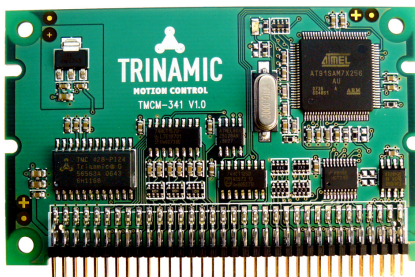

TMCM-341

3-axis
controller board
for SPI drivers
 V_{logic} 5V DC

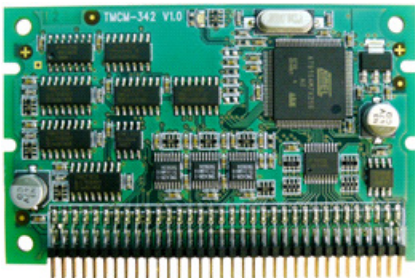

TMCM-342

3-axis
controller board
for step/dir drivers
 V_{logic} 5V DC

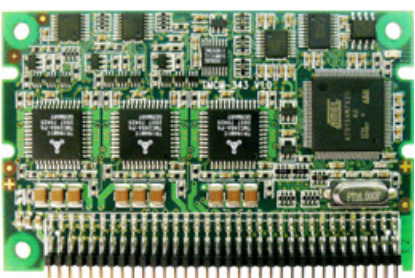

TMCM-343

3-axis stepper
controller/driver board
 V_{nom} 8...34 V DC / V_{logic} 5V DC
1.1A RMS

+

+

TRINAMIC Motion Control GmbH & Co. KG
Hamburg, Germany

www.trinamic.com



TRINAMIC
MOTION CONTROL

Table of Contents

1	Preface	6
1.1	General Features of the CANopen Implementation	6
1.2	Abbreviations	7
1.3	Firmware Update	7
2	Communication	8
2.1	Reference Model	8
2.2	NMT State Machine	9
2.3	Device Model	11
2.4	Object Dictionary	12
3	Communication Objects	13
3.1	Detailed Object Specifications	13
3.1.1	Object 1000 _h : Device Type	13
3.1.2	Object 1001 _h : Error Register	13
3.1.3	Object 1005 _h : COB-ID SYNC Message	14
3.1.4	Object 1008 _h : Manufacturer Device Name	14
3.1.5	Object 1009 _h : Manufacturer Hardware Version	14
3.1.6	Object 100A _h : Manufacturer Software Version	14
3.1.7	Object 100C _h : Guard Time	15
3.1.8	Object 100D _h : Life Time Factor	15
3.1.9	Object 1010 _h : Store Parameters	15
3.1.10	Object 1011 _h : Restore Default Parameters	16
3.1.11	Object 1014 _h : COB-ID Emergency Object	18
3.1.12	Object 1015 _h : Inhibit Time EMCY	18
3.1.13	Object 1016 _h : Consumer Heartbeat Time	18
3.1.14	Object 1017 _h : Producer Heartbeat Time	18
3.1.15	Object 1018 _h : Identity Object	19
3.1.16	Object 1023 _h : OS Command	19
3.1.17	Object 1029 _h : Error Behavior	19
3.1.18	Objects 1400 _h -1405 _h : Receive PDO Communication Parameter	20
3.1.19	Objects 1440 _h -1445 _h : Receive PDO Communication Parameter	20
3.1.20	Objects 1480 _h -1485 _h : Receive PDO Communication Parameter	21
3.1.21	Objects 1600 _h -1605 _h : Receive PDO Mapping	22
3.1.22	Objects 1640 _h -1645 _h : Receive PDO Mapping	23
3.1.23	Objects 1680 _h -1685 _h : Receive PDO Mapping	24
3.1.24	Objects 1800 _h -1805 _h : Transmit PDO Communication Parameter	25
3.1.25	Objects 1840 _h -1845 _h : Transmit PDO Communication Parameter	26
3.1.26	Objects 1880 _h -1885 _h : Transmit PDO Communication Parameter	27
3.1.27	Objects 1A00 _h -1A05 _h : Transmit PDO Mapping Parameter	28
3.1.28	Objects 1A40 _h -1A45 _h : Transmit PDO Mapping Parameter	29
3.1.29	Objects 1A80 _h -1A85 _h : Transmit PDO Mapping Parameter	30
4	Device Profile Objects (CiA402) and Modes of Operation	31
4.1	Detailed Object Specifications	31
4.1.1	Object 605A _h , 685A _h , and 705A _h : Quick Stop Option Code	31
4.1.2	Object 605B _h , 685B _h , and 705B _h : Shutdown Option Code	32
4.1.3	Object 605C _h , 685C _h , and 705C _h : Disable Operation Option Code	32
4.1.4	Object 605D _h , 685D _h , and 705D _h : Halt Option Code	32
4.1.5	Object 605E _h , 685E _h , and 705E _h : Fault Reaction Option Code	33
4.1.6	Object 6060 _h , 6860 _h , and 7060 _h : Modes of Operation	33
4.1.7	Object 6061 _h , 6861 _h , and 7061 _h : Modes of Operation Display	34
4.1.8	Object 606A _h , 686A _h , and 706A _h : Sensor Selection Code	34
4.1.9	Object 6085 _h , 6885 _h , and 7085 _h : Quick Stop Deceleration	35
4.1.10	Object 608F _h , 688F _h , and 708F _h : Position Encoder Resolution	35
4.1.11	Object 60C5 _h , 68C5 _h , and 70C5 _h : Max Acceleration	35
4.1.12	Object 60C6 _h , 68C6 _h , and 70C6 _h : Max Deceleration	36
4.1.13	Object 60FD _h , 68FD _h , and 70FD _h : Digital Inputs	36
4.1.14	Object 6502 _h , 6D02 _h , and 7502 _h : Supported Drive Modes	37

4.2	Profile Position Mode.....	38
4.2.1	Detailed object specifications.....	38
4.2.1.1	Object 6040 _h , 6840 _h , and 7040 _h : Controlword	39
4.2.1.2	Object 6041 _h , 6841 _h , and 7041 _h : Statusword.....	40
4.2.1.3	Object 6062 _h , 6862 _h , and 7062 _h : Position Demand Value	41
4.2.1.4	Object 6063 _h , 6863 _h , and 7063 _h : Position Actual Internal Value.....	41
4.2.1.5	Object 6064 _h , 6864 _h , and 7064 _h : Position Actual Value	41
4.2.1.6	Object 6065 _h , 6865 _h , and 7065 _h : Following Error Window.....	42
4.2.1.7	Object 6067 _h , 6867 _h , and 7067 _h : Position Window.....	42
4.2.1.8	Object 6068 _h , 6868 _h , and 7068 _h : Position Window Time	43
4.2.1.9	Object 606C _h , 686C _h , and 706C _h : Velocity Actual Value.....	43
4.2.1.10	Object 607A _h , 687A _h , and 707A _h : Target Position.....	43
4.2.1.11	Object 607D _h , 687D _h , and 707D _h : Software Position Limit	44
4.2.1.12	Object 607F _h , 687F _h , and 707F _h : Maximum Profile Velocity.....	44
4.2.1.13	Object 6081 _h , 6881 _h , and 7081 _h : Profile Velocity.....	44
4.2.1.14	Object 6083 _h , 6883 _h , and 7083 _h : Profile Acceleration	45
4.2.1.15	Object 6084 _h , 6884 _h , and 7084 _h : Profile Deceleration.....	45
4.2.1.16	Object 6086 _h , 6886 _h , and 7086 _h : Motion Profile Type.....	45
4.2.2	How to move a motor in <i>pp</i> mode.....	46
4.3	Homing Mode.....	47
4.3.1	Connecting home switch, left switch, and right switch.....	48
4.3.1.1	TMCM-341/342/343	48
4.3.1.2	TMCM-351.....	49
4.3.2	Connecting a brake.....	50
4.3.2.1	TMCM-341/342/343	50
4.3.2.2	TMCM-351.....	50
4.3.3	Homing Methods.....	51
4.3.4	Detailed Object Definitions	54
4.3.4.1	Object 6040 _h , 6840 _h , and 7040 _h : Controlword	54
4.3.4.2	Object 6041 _h , 6841 _h , and 7041 _h : Statusword.....	55
4.3.4.3	Object 606C _h , 686C _h , and 706C _h : Velocity Actual Value.....	55
4.3.4.4	Object 607C _h , 687C _h , and 707C _h : Home Offset.....	56
4.3.4.5	Object 6098 _h , 6898 _h , and 7098 _h : Homing Method	56
4.3.4.6	Object 6099 _h , 6899 _h , and 7099 _h : Homing Speeds	57
4.3.4.7	Object 609A _h , 689A _h , and 709A _h : Homing Acceleration	57
4.3.4.8	Object 2100 _h : Home Offset Display	57
4.3.5	How to start a homing in <i>hm</i> mode	58
4.4	Velocity Mode.....	59
4.4.1	Detailed object definitions	59
4.4.1.1	Object 6040 _h , 6840 _h , and 7040 _h : Controlword	59
4.4.1.2	Object 6041 _h , 6841 _h , and 7041 _h : Statusword.....	60
4.4.1.3	Object 6042 _h , 6842 _h , and 7042 _h : <i>vl</i> Target Velocity.....	60
4.4.1.4	Object 6043 _h , 6843 _h , and 7043 _h : <i>vl</i> Velocity Demand	61
4.4.1.5	Object 6044 _h , 6844 _h , and 7044 _h : <i>vl</i> Velocity Actual Value	61
4.4.1.6	Object 6046 _h , 6846 _h , and 7046 _h : <i>vl</i> Velocity Min Max Amount.....	61
4.4.1.7	Object 6048 _h , 6848 _h , and 7048 _h : <i>vl</i> Velocity Acceleration.....	62
4.4.1.8	Object 6049 _h , 6849 _h , and 7049 _h : <i>vl</i> Velocity Deceleration	62
4.4.2	How to Move a Motor in <i>vl</i> Mode.....	63
4.5	Profile Velocity Mode	64
4.5.1.1	Object 6040 _h , 6840 _h , and 7040 _h : Controlword	64
4.5.1.2	Object 6041 _h , 6841 _h , and 7041 _h : Statusword.....	65
4.5.1.3	Object 6062 _h , 6862 _h , and 7062 _h : Position Demand Value	65
4.5.1.4	Object 6063 _h , 6863 _h , and 7063 _h : Position Actual Internal Value.....	66
4.5.1.5	Object 6064 _h , 6864 _h , and 7064 _h : Position Actual Value	66
4.5.1.6	Object 6065 _h , 6865 _h , and 7065 _h : Following Error Window.....	66
4.5.1.7	Object 606C _h , 686C _h , and 706C _h : Velocity Actual Value.....	67
4.5.1.8	Object 607D _h , 687D _h , and 707D _h : Software Position Limit	67
4.5.1.9	Object 6083 _h , 6883 _h , and 7083 _h : Profile Acceleration	67

4.5.1.10	Object 6084 _h , 6884 _h , and 7084 _h : Profile Deceleration.....	68
4.5.1.11	Object 60FF _h , 62FF _h , and 64FF _h : Target Velocity.....	68
4.5.2	How to Move a Motor in <i>pv</i> Mode.....	68
5	Manufacturer Specific Area.....	69
5.1	Detailed Object Specifications.....	69
5.1.1	Object 2000 _h , 2200 _h , and 2400 _h : Microstep Resolution.....	69
5.1.2	Object 2001 _h , 2201 _h , and 2401 _h : Fullstep Resolution.....	69
5.1.3	Object 2002 _h , 2202 _h , and 2402 _h : Brake Delay Times.....	70
5.1.4	Object 2003 _h , 2203 _h , and 2403 _h : Maximum Current.....	70
5.1.5	Object 2004 _h , 2204 _h , and 2404 _h : Standby Current.....	71
5.1.6	Object 2005 _h , 2205 _h , and 2405 _h : Limit Switches.....	71
5.1.7	Object 2006 _h , 2206 _h , and 2406 _h : Mixed Decay Threshold.....	72
5.1.8	Object 2007 _h , 2207 _h , and 2407 _h : Stall Detection Threshold.....	72
5.1.9	Object 2009 _h , 2209 _h , and 2409 _h : Fullstep Threshold.....	72
5.1.10	Object 200A _h , 220A _h , and 240A _h : Enable Drive Delay Time.....	73
5.1.11	Object 200B _h , 220B _h , and 240B _h : Encoder parameters.....	73
5.1.12	Object 200C _h , 220C _h , and 240C _h : Brake Current Feed.....	74
5.1.13	Object 204E _h , 224E _h , and 244E _h : Boost Current.....	74
5.1.14	Object 2085 _h , 2285 _h , and 2485 _h : Ramp Divisor.....	74
5.1.15	Object 2086 _h , 2286 _h , and 2486 _h : Pulse Divisor.....	75
5.1.16	Object 2087 _h , 2287 _h , and 2487 _h : Maximum Velocity.....	75
5.1.17	Object 2088 _h , 2288 _h , and 2488 _h : Maximum Acceleration.....	76
5.1.18	Object 208C _h , 228C _h , and 248C _h : Velocity Dimension Index.....	76
5.1.19	Object 208E _h , 228E _h , and 248E _h : Acceleration Dimension Index.....	77
5.1.20	Object 2100 _h , 2300 _h , and 2500 _h : Home Offset Display.....	77
5.1.21	Object 2101 _h , 2301 _h , and 2501 _h : Actual stallGuard™ Load Value.....	77
5.1.22	Object 2102 _h , 2302 _h , and 2502 _h : Driver Error Flags.....	78
5.1.23	Object 2103 _h , 2303 _h , and 2503 _h : Pulse Divisor Display.....	78
5.1.24	Object 2104 _h , 2304 _h , and 2504 _h : Maximum Velocity Display.....	78
5.1.25	Object 2105 _h , 2305 _h , and 2505 _h : Ramp Divisor Display.....	79
5.1.26	Object 2106 _h , 2306 _h , and 2506 _h : Maximum Acceleration Display.....	79
5.1.27	Object 2107 _h , 2307 _h , and 2507 _h : Microstep Resolution Display.....	79
5.1.28	Object 2700 _h : TMCL™ Direct Communication.....	79
5.1.29	Object 2701 _h : Manufacturer Specific Mode.....	80
5.1.30	Object 2702 _h : Digital Inputs.....	80
5.1.31	Object 2703 _h : Digital Outputs.....	80
5.1.32	Object 2704 _h : CAN Bit Rate.....	81
5.1.33	Object 2705 _h : Node ID.....	81
5.1.34	Object 2706 _h : Store.....	82
5.1.35	Object 2707 _h : CAN bit Rate Load.....	82
5.1.36	Object 2708 _h : Node ID load.....	82
5.1.37	Object 2709 _h : Encoder Interface.....	82
5.1.38	Object 270A _h : Encoder Interface Display.....	83
5.1.39	Object 270E _h : Device Analog Inputs.....	83
5.1.40	Object 2710 _h : Pull-up Resistors (TMCM-351 only).....	83
6	Emergency Messages.....	84
7	Life Support Policy.....	86
8	Revision History.....	87
8.1	Firmware revision.....	87
8.2	Document Revision.....	88
9	References.....	89

Table of Figures

Figure 2.1 Overview CANopen NMT state machine.....	9
Figure 2.2 Communication architecture	10
Figure 2.3 Device model.....	11
Figure 3.1 Restore procedure	17
Figure 4.1 Finite state machine	38
Figure 4.2 Homing mode function (motor 0).....	47
Figure 4.3: 68-pin connector of the TMCM-34x.....	48
Figure 4.4: Pin order of the connector.....	48
Figure 4.5: Connectors of TMCM-351	49
Figure 4.6 Homing on negative switch and index pulse.....	51
Figure 4.7 Homing on positive limit switch and index pulse.....	51
Figure 4.8 Homing on positive home switch and index pulse.....	52
Figure 4.9 Homing on negative home switch and index pulse.....	52
Figure 4.10 Homing without index pulse.....	53
Figure 4.11 Homing on index pulse.....	53
Figure 4.12 Home offset definition.....	56
Figure 4.13 Transfer characteristic of the velocity acceleration	62
Figure 5.1 Brake output timing.....	70

1 Preface

This document specifies objects and modes of operation of the TRINAMIC modules TCM-341, TCM-342, TCM-343, and TCM-351 with CANopen firmware. As these products are stepper motor controller and driver modules the use of the CiA DSP402 protocol (described in the *CiA CANopen drives and motion control device profile, Part 2*) is fundamental. The CANopen firmware is designed to fulfill the DS301 version 4.02 and DS402 version 3.0 standards. The CiA conformance has also been tested. This CANopen firmware has been developed to turn the ARM-based TRINAMIC motion control modules into CANopen compatible ones. There are versions for each module. This manual assumes that the reader is already familiar with the basics of the CANopen protocol (especially DS301 and DS402). On the following pages you will find a short overview and afterwards the information will be more in detail.

If necessary, you can always turn the board back into a TMCL module by loading the TMCL firmware into the drive again.

1.1 General Features of the CANopen Implementation

MAIN CHARACTERISTICS

Communication according to standard CiA-301 V4.1

CAN bit rate: 20... 1000kBit/s

CAN ID: 11 bit

Node ID: 1... 127 (use vendor specific objects)

NMT services: NMT slave

SDO communication

- 1 server
- Expedited transfer
- Segmented transfer
- No block transfer

PDO communication

- Producer
- Consumer
- *RPDOs*
 - Axis 0: 1, 2, 3, 4, 6
 - Axis 1: 65, 66, 67, 68, 70
 - Axis 2: 129, 130, 131, 132, 134
 - Transmission modes: asynchronous
 - Dynamic mapping with max. 3 mapping entries
 - Default mappings: according to CiA-402 for PDO 1, 2, 3 and 6, manufacturer specific for PDO4
- *TPDOs*
 - Axis 0: 1, 2, 3, 4, 6
 - Axis 1: 65, 66, 67, 68, 70
 - Axis 2: 129, 130, 131, 132, 134
 - Transmission modes: asynchronous, asynchronous with event timer, synchronous
 - Dynamic mapping with max. 3 mapping entries
 - Default mappings: according to CiA-402 for PDO 1, 2, 3 and 6, manufacturer specific for PDO

Further Characteristics

SYNC: consumer (TPDO3, TPDO6, TPDO67, TPDO70, TPDO131, and TPDO134 are synchronous PDOs)

Emergency: producer

RTR: supported only for node guarding/life guarding

Heartbeat: consumer and producer

1.2 Abbreviations

ABBREVIATIONS	
CAN	Controller area network
CHGND	chassis ground / earth ground
COB	Communication object
FSA/ FSM	Finite state automaton/ Finite state machine
NMT	Network management
ID	Identifier
LSB	Least significant bit
MSB	Most significant bit
PDO	Process data object
PDS	Power drive system
RPDO	Receive process data object
SDO	Service data object
TPDO	Transmit process data object
EMCY	Emergency object
rw	Read and write
ro	Read only
hm	Homing mode
pp	Profile position mode
pv	Profile velocity mode
vm	Velocity mode

Table 1.1 Abbreviations

1.3 Firmware Update

The software running on the microprocessor consists of two parts, a boot loader and the CANopen firmware itself. Whereas the boot loader is installed during production and testing at TRINAMIC and remains untouched throughout the whole lifetime, the CANopen firmware can easily be updated by the user. New versions can be downloaded free of charge from the TRINAMIC website (<http://www.trinamic.com>). The CANopen firmware can be loaded into the modules easily just by using the firmware update function of the TMCL-IDE.

2 Communication

2.1 Reference Model

The application layer comprises a concept to configure and communicate real-time-data which synchronizes devices. The functionality the application layer offers to an application is logically divided over different *service data objects* (SDO) in the application layer. A service object offers a specific functionality and all the related services.

Applications interact by invoking services of a service object in the application layer. To realize these services this object exchanges data via the CAN Network with peer service object(s) using a protocol.

The application and the application layer interact with *service primitives*.

SERVICE PRIMITIVES	
Request	Issued by the application to the application layer to request a service.
Indication	Issued by the application layer to the application to report an internal event detected by the application layer or indicate that a service is requested.
Response	Issued by the application to the application layer to respond to a previous received indication.
Confirmation	Issued by the application layer to the application to report the result of a previously issued request.

Table 2.1 Service primitives

A *service type* defines the primitives that are exchanged between the application layer and the cooperating applications for a particular service of a service object. Unconfirmed and confirmed services are collectively called *remote services*.

SERVICE TYPES	
Local service	Involves only the local service object. The application issues a request to its local service object that executes the requested service without communicating with peer service object(s).
Unconfirmed service	Involves one or more peer service objects. The application issues a request to its local service object. This request is transferred to the peer service object(s) that each passes it to their application as an indication. The result is not confirmed back.
Confirmed service	Can involve only one peer service object. The application issues a request to its local service object. This request is transferred to the peer service object that passes it to the other application as an indication. The other application issues a response that is transferred to the originating service object that passes it as a confirmation to the requesting application.
Provider initiated service	Involves only the local service object. The service object (being the service provider) detects an event not solicited by a requested service. This event is then indicated to the application.

Table 2.2 Service types

2.2 NMT State Machine

The finite state machine (FSM) or simply state machine is a model of behavior composed of a finite number of states, transitions between those states, and actions. It shows which way the logic runs when certain conditions are met.

Starting and resetting the device is controlled via the state machine. The NMT state machine contains the following states:

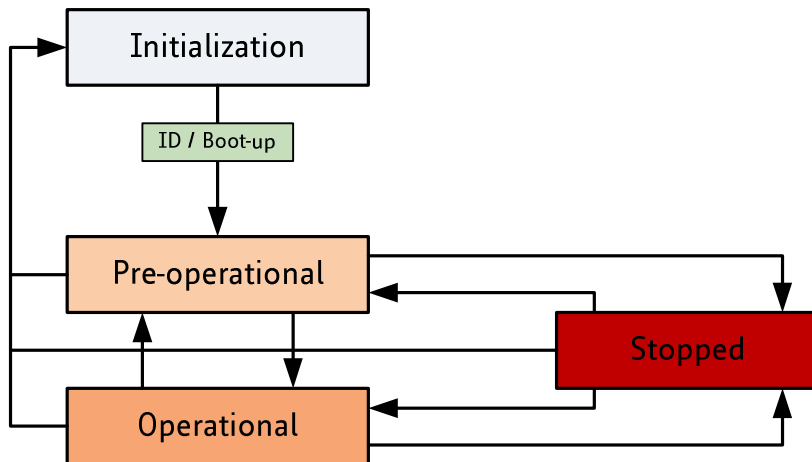

Figure 2.1 Overview CANopen NMT state machine

After power-on or reset the device enters the **Initialization state**.

After the device initialization is finished, the device automatically transits to the **Pre-operational state** and indicates this state transition by sending the boot-up message. This way the device indicates that it is ready to work. A device that stays in Pre-operational state may start to transmit SYNC-, time stamp- or heartbeat message. In contrast to the PDO communication which is disabled in this state, the device can communicate via SDO.

The PDO communication is only possible within the **Operational state**. During Operational state the device can use all supported communication objects.

A device that was switched to the **Stopped state** only reacts on received NMT commands. In addition the device indicates the current NMT state by supporting the error control protocol during Stopped state.

The transitions between states are made by issuing a network management (NMT) communication object to the device. The NMT protocols are used to generate state machine change commands (e.g. to start and to stop the device), detect remote device boot-ups and error conditions.

The Heartbeat message of a CANopen device contains the device status of the NMT state machine and is sent cyclically by the CANopen device.

The Figure 2.2 shows the situation of the state machine in this device profile.

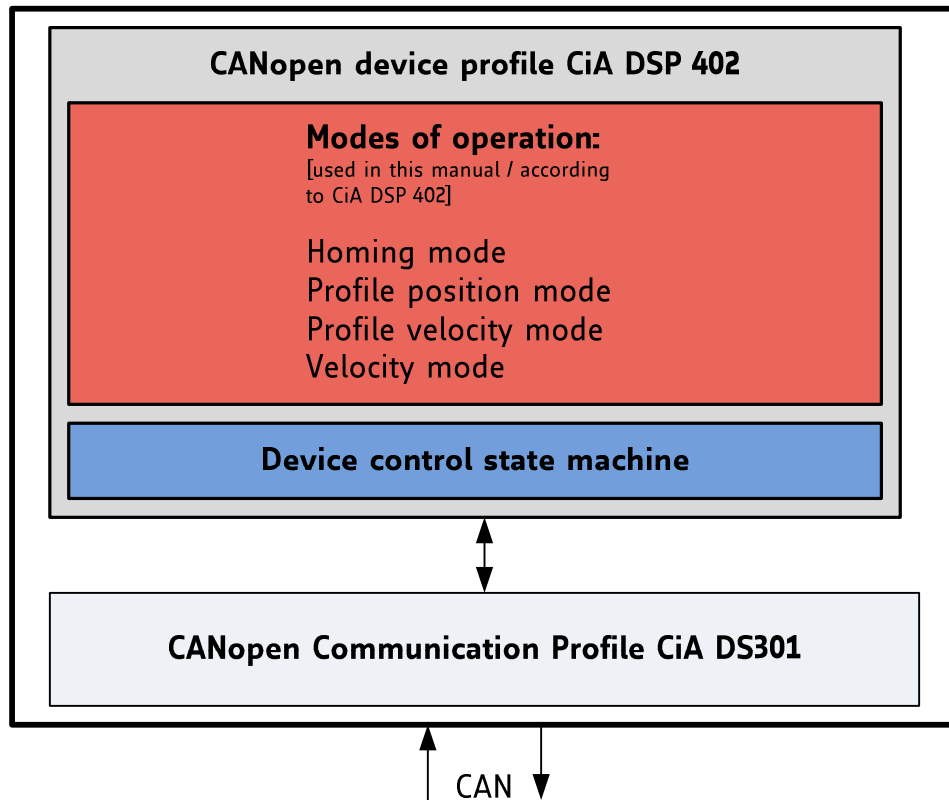

Figure 2.2 Communication architecture

2.3 Device Model

Following the *device model*, the device consists of three parts: communication, object dictionary, and application.

Communication This function unit provides the communication objects and the appropriate functionality to transport data items via the underlying network structure.

Object dictionary The object dictionary is a collection of all the data items which have an influence on the behavior of the application objects, the communication objects and the state machine used on this device.

Application The application comprises the functionality of the device with respect to the interaction with the process environment.

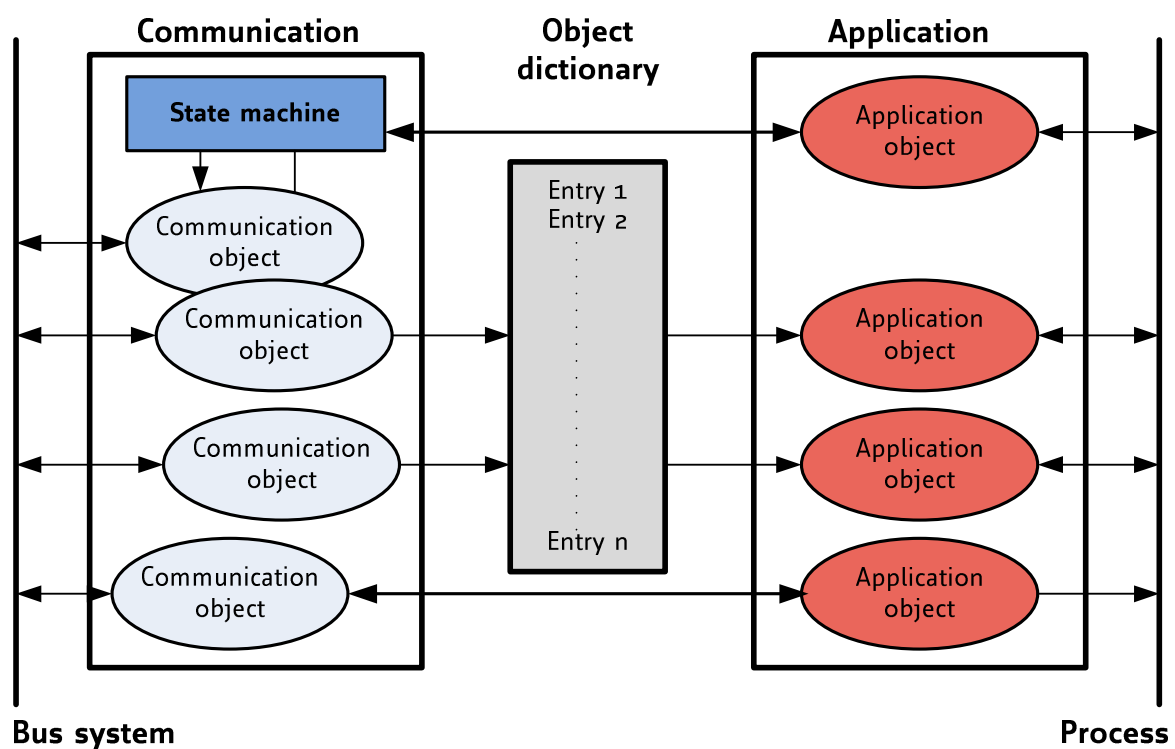

Figure 2.3 Device model

2.4 Object Dictionary

The most important part of a device profile is the object dictionary description. The Object Dictionary is essentially a grouping of objects accessible via the network in an ordered pre-defined fashion. Each object within the dictionary is addressed using a 16-bit index.

THE OVERALL LAYOUT OF THE STANDARD OBJECT DICTIONARY IS AS FOLLOWS:

Index (hex)	Object
0000	Not used
0001 - 001F	Static data types
0020 - 003F	Complex data types
0040 - 005F	Manufacturer specific complex data types
0060 - 007F	Device profile specific static data types
0080 - 009F	Device profile specific complex data types
00A0 - 0FFF	Reserved for further use
1000 - 1FFF	Communication profile area* ¹
2000 - 5FFF	Manufacturer specific profile area* ²
6000 - 9FFF	Standardized device profile area* ³
A000 - BFFF	Standardized interface profile area
C000 - FFFF	Reserved for further use

Table 2.3 Object Dictionary

*¹ The communication profile area at indices 1000_h through 1FFF_h contains the communication specific parameters for the CAN network. These entries are common to all devices.

*² The manufacturer segment at indices 2000_h through 5FFF_h contains manufacturer specific objects. These objects control special features of the TRINAMIC TMCM-34x resp. TMCM-351 modules.

*³ The standardized device profile area at indices 6000_h through 9FFF_h contains all data objects common to a class of devices that can be read or written via the network. The device profiles use entries from 6000_h to 9FFF_h to describe the device parameters and the device functionality.

3 Communication Objects

3.1 Detailed Object Specifications

3.1.1 Object 1000_h: Device Type

This object contains information about the device type. The object 1000_h describes the type of device and its functionality. It is composed of a 16-bit field which describes the device profile that is used and a second 16-bit field which gives additional information about optional functionality of the device.

OBJECT DESCRIPTION

Index	Name	Object Code	Data Type
1000 _h	Device type	Variable	UNSIGNED32

ENTRY DESCRIPTION

Sub-Index	Access	PDO Mapping	Value Range	Default Value
00 _h	r0	no	UNSIGNED32	40192 _h

3.1.2 Object 1001_h: Error Register

This object is an error register. The module can map internal errors and object 1001_h is part of an emergency object.

OBJECT DESCRIPTION

Index	Name	Object Code	Data Type
1001 _h	Error register	Variable	UNSIGNED8

ENTRY DESCRIPTION

Sub-Index	Access	PDO Mapping	Value Range	Default Value
00 _h	r0	yes	UNSIGNED8	no

STRUCTURE OF THE ERROR REGISTER

Bit	M/O	Description
0	M	Generic error
1	0	Current
2	0	Voltage
3	0	Temperature
4	0	Communication error
5	0	Device profile specific
6	0	Reserved (always 0)
7	0	Manufacturer specific

If a bit is set to 1, the specific error has occurred.

3.1.3 Object 1005_h: COB-ID SYNC Message

This object defines the COB-ID of the synchronization Object (SYNC). Further, it defines whether the module generates the SYNC.

OBJECT DESCRIPTION

Index	Name	Object Code	Data Type
1005 _h	COB-ID SYNC Message	Variable	UNSIGNED32

ENTRY DESCRIPTION

Sub-Index	Access	PDO Mapping	Value Range	Default Value
00 _h	rw	no	UNSIGNED32	80 _h

3.1.4 Object 1008_h: Manufacturer Device Name

This object contains the manufacturer device name.

OBJECT DESCRIPTION

Index	Name	Object Code	Data Type
1008 _h	Manufacturer device name	Variable	visible string

ENTRY DESCRIPTION

Sub-Index	Access	PDO Mapping	Value Range	Default Value
00 _h	Const.	no	no	<i>module specific:</i> TMC-341 TMC-342 TMC-343 TMC-351

3.1.5 Object 1009_h: Manufacturer Hardware Version

This object contains the hardware version description.

OBJECT DESCRIPTION

Index	Name	Object Code	Data Type
1009 _h	Manufacturer hardware version	Variable	visible string

ENTRY DESCRIPTION

Sub-Index	Access	PDO Mapping	Value Range	Default Value
00 _h	Const.	no	no	<i>depends on hardware version</i>

3.1.6 Object 100A_h: Manufacturer Software Version

This object contains the software version description.

OBJECT DESCRIPTION

Index	Name	Object Code	Data Type
100A _h	Manufacturer software version	Variable	visible string

ENTRY DESCRIPTION

Sub-Index	Access	PDO Mapping	Value Range	Default Value
00 _h	Const.	no	no	<i>according to software version</i>

3.1.7 Object 100C_h: Guard Time

The objects at index 100C_h and 100D_h shall indicate the configured guard time respectively the life time factor. The life time factor multiplied with the guard time gives the life time for the life guarding protocol.

OBJECT DESCRIPTION

Index	Name	Object Code	Data Type
100C _h	Guard time	Variable	UNSIGNED16

ENTRY DESCRIPTION

Sub-Index	Access	PDO Mapping	Value Range	Default Value
00 _h	rw <i>ro, if life guarding is not supported</i>	no	UNSIGNED16	0000 _h

3.1.8 Object 100D_h: Life Time Factor

The life time factor multiplied with the guard time gives the life time for the life guarding protocol.

OBJECT DESCRIPTION

Index	Name	Object Code	Data Type
100D _h	Life time factor	Variable	UNSIGNED8

ENTRY DESCRIPTION

Sub-Index	Access	PDO Mapping	Value Range	Default Value
00 _h	rw <i>ro, if life guarding is not supported</i>	no	UNSIGNED8	00 _h

3.1.9 Object 1010_h: Store Parameters

This object supports the saving of parameters in non volatile memory. By read access the device provides information about its saving capabilities.

This command can only be carried out if the module is in ready to switch on mode.

SEVERAL PARAMETER GROUPS ARE DISTINGUISHED:

- Sub-index 0_h contains the largest sub-index that is supported.
- Sub-index 1_h saves all parameters.
- Sub-index 2_h: saves communication parameters 100C_h, 100D_h, 1015_h, 1017_h, and 1029_h.
- Sub-index 4_h stores parameters for the motor axis 0.
- Sub-index 5_h stores parameters for the motor axis 1.
- Sub-index 6_h stores parameters for the motor axis 2.
- Sub-index 7_h: saves device parameters / TRINAMIC specific parameters (2000_h... 270E_h).

In order to avoid storage of parameters by mistake, storage is only executed when a specific signature is written to the appropriate Sub-Index. This signature is *safe*.

Storage write access structure

Signature	MSB		LSB	
ISO 8859 ASCII	e	v	a	s
hex	65 _h	76 _h	61 _h	73 _h

On reception of the correct signature in the appropriate sub-index the device stores the parameter and then confirms the SDO transmission (initiate download response). If the storing failed, the device responds with an Abort SDO transfer (abort code: 0606 0000_h).

If a wrong signature is written, the device refuses to store and responds with Abort SDO transfer (abort code: 0800 002x_h).

On read access to the appropriate sub-index the device provides information about its storage functionality with the following format.

Storage read access structure

UNSIGNED 32			
MSB		LSB	
bits	31-2	1	0
	reserved	1/0	1/0

Bit-number	Value	Meaning
31-2	0	reserved
1	0	Device does not save parameters autonomously
	1	Device saves parameters autonomously
0	0	Device does not save parameters on command
	1	Device saves parameters on command

Autonomous saving means that a device stores the storable parameters in a non-volatile manner without user request.

OBJECT DESCRIPTION

Index	Name	Object Code	Data Type
1010 _h	Store parameters	ARRAY	UNSIGNED 32

ENTRY DESCRIPTION

Sub-Index	Description	Access	PDO Mapping	Value Range	Default Value
00 _h	Largest sub-index supported	ro	no	1 _h -7F _h	no
01 _h	Save all parameters	rw	no	UNSIGNED32	no
02 _h	Save special communication parameters	rw	no	UNSIGNED32	no
04 _h	Save motor axis 1 parameters	rw	no	UNSIGNED32	no
05 _h	Save motor axis 2 parameters	rw	no	UNSIGNED32	no
06 _h	Save motor axis 3 parameters	rw	no	UNSIGNED32	no
07 _h	Save device parameters (TRINAMIC specific parameters)	rw	no	UNSIGNED32	no

Please mind the figures above which explain the value ranges of the write access and the read access for the sub-indices.

3.1.10 Object 1011_h: Restore Default Parameters

With this object the default values of parameters according to the communication or device profile are restored. By read access the device provides information about its capabilities to restore these values.

This command can only be carried out if the module is in ready to switch on mode.

SEVERAL PARAMETER GROUPS ARE DISTINGUISHED:

- Sub-index 0_h: contains the largest sub-index that is supported.
- Sub-index 1_h: restores all parameters.
- Sub-index 2_h: restores communication parameters 100C_h, 100D_h, 1015_h, 1017_h, and 1029_h.
- Sub-index 4_h: restores motor axis 0 parameters
- Sub-index 5_h: restores motor axis 1 parameters
- Sub-index 6_h: restores motor axis 2 parameters
- Sub-index 7_h: restores device parameters / TRINAMIC specific parameters (2000_h... 270E_h).

In order to avoid the restoring of default parameters by mistake, restoring is only executed when a specific signature is written to the appropriate sub-index. The signature is *load*.

Signature	MSB		LSB	
ASCII	d	a	o	l
hex	64 _h	61 _h	6F _h	6C _h

On reception of the correct signature in the appropriate sub-index the device restores the default parameters and then confirms the SDO transmission (initiate download response). If the restoring failed, the device responds with an Abort SDO Transfer (abort code: 0606 0000_h). If a wrong signature is written, the device refuses to restore the defaults and responds with an Abort SDO Transfer (abort code: 0800 002x_h).

The default values are set valid after the device is reset (reset node for sub-index 1h – 7Fh, reset communication for sub-index 2_h) or power cycled.

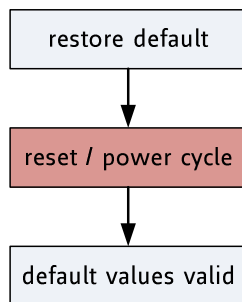

Figure 3.1 Restore procedure

On read access to the appropriate sub-index the device provides information about its default parameter restoring capability with the following format.

Structure of restore read access

UNUNSIGNED 32		MSB	LSB
bits	31-1	0	0/1
	reserved (0)		

OBJECT DESCRIPTION

Index	Name	Object Code	Data Type
1011 _h	Restore default parameters	ARRAY	UNUNSIGNED 32

ENTRY DESCRIPTION

Sub-Index	Description	Access	PDO Mapping	Value Range	Default Value
00 _h	Largest sub-index supported	ro	no	1 _h -7F _h	no
01 _h	Restore all default parameters	rw	no	UNUNSIGNED32	no
02 _h	Restore special communication parameters	rw	no	UNUNSIGNED32	no
04 _h	Restore motor axis 0 parameters	rw	no	UNUNSIGNED32	no
05 _h	Restore motor axis 1 parameters	rw	no	UNUNSIGNED32	no
06 _h	Restore motor axis 2 parameters	rw	no	UNUNSIGNED32	no
07 _h	Restore device parameters (TRINAMIC specific parameters)	rw	no	UNUNSIGNED32	no

Please mind the figures above which explain the value ranges of the write access and the read access for the sub-indices.

3.1.11 Object 1014_h: COB-ID Emergency Object

This object defines the COB-ID of the emergency object (EMCY).

OBJECT DESCRIPTION

Index	Name	Object Code	Data Type
1014 _h	COB-ID emergency object	Variable	UNSIGNED32

ENTRY DESCRIPTION

Sub-Index	Access	PDO Mapping	Value Range	Default Value
00 _h	rw	no	UNSIGNED32	80 _h + NODE ID

3.1.12 Object 1015_h: Inhibit Time EMCY

The inhibit time for the EMCY message can be adjusted via this entry. The time has to be a multiple of 100µs.

OBJECT DESCRIPTION

Index	Name	Object Code	Data Type
1015 _h	Inhibit time EMCY	Variable	UNSIGNED16

ENTRY DESCRIPTION

Sub-Index	Access	PDO Mapping	Value Range	Default Value
00 _h	rw	no	UNSIGNED16	0

3.1.13 Object 1016_h: Consumer Heartbeat Time

The consumer heartbeat time defines the expected heartbeat cycle time and thus has to be higher than the corresponding producer heartbeat time configured on the module producing this heartbeat. The monitoring starts after the reception of the first heartbeat. If the consumer heartbeat time is 0 the corresponding entry is not used. The time has to be a multiple of 1ms.

	MSB		LSB
<i>bits</i>	31-24	23-16	15-0
<i>value</i>	Reserved	Node-ID	Heartbeat time
<i>encoded as</i>	-	UNSIGNED8	UNSIGNED16

Table 3.1 Structure of consumer heartbeat time entry

OBJECT DESCRIPTION

Index	Name	Object Code	Data Type
1016 _h	Consumer heartbeat time	ARRAY	UNSIGNED32

ENTRY DESCRIPTION

Sub-Index	Description	Access	PDO Mapping	Value Range	Default Value
00 _h	Number of entries	ro	no	0... 127	no
01 _h	Consumer heartbeat time	rw	no	UNSIGNED32	no

3.1.14 Object 1017_h: Producer Heartbeat Time

The producer heartbeat time defines the cycle time of the heartbeat. The producer heartbeat time is 0 if it is not used. The time has to be a multiple of 1ms.

OBJECT DESCRIPTION

Index	Name	Object Code	Data Type
1017 _h	Producer heartbeat time	Variable	UNSIGNED16

ENTRY DESCRIPTION

Sub-Index	Access	PDO Mapping	Value Range	Default Value
00 _h	rw	no	UNSIGNED16	0

3.1.15 Object 1018_h: Identity Object

The object 1018_h contains general information about the device.

- The Vendor ID (sub-index 01_h) contains a unique value allocated to each manufacturer. The vendor ID of TRINAMIC is 0286_h.
- The manufacturer-specific Product code (sub-index 2_h) identifies a specific device version.
- The Manufacturer-specific Revision number (sub-index 3_h) consists of a major revision number and a minor revision number.

OBJECT DESCRIPTION

Index	Name	Object Code	Data Type	Category
1018 _h	Identity object	RECORD	Identity	Optional

ENTRY DESCRIPTION

Sub-Index	Description	Access	PDO Mapping	Value Range	Default Value
00 _h	Number of entries	ro	no	0.. 3	number of entries:3
01 _h	Vendor ID (TRINAMIC)	ro	no	UNSIGNED32	reads 0286 _h
02 _h	Product code	ro	no	UNSIGNED32	depends on device e.g. 341, 342, 343, 351
03 _h	Revision number	ro	no	UNSIGNED32	firmware revision number; reads e.g. 2003 _h for version 2.3
04 _h	Serial number	ro	no	UNSIGNED32	serial number

3.1.16 Object 1023_h: OS Command

The OS Command object is used as a command driven interface to programmable devices. The host system puts the command into the object OS Command, which is of the type Command Par.

OBJECT DESCRIPTION

Index	Name	Object Code	Data Type	Category
1023 _h	OS command	RECORD	Command Par	Optional

ENTRY DESCRIPTION

Sub-Index	Description	Access	PDO Mapping	Value Range	Default Value
00 _h	Number of supported entries	ro	no	3	number of entries: 3 (for direct TMCL communication)
01 _h	Command (TMCL command)	rw	no	Octet string	no
02 _h	Status (error code of a TMCL command)	ro	no	UNSIGNED8	no
03 _h	Reply (reply of a TMCL command)	ro	no	Octet string	no

3.1.17 Object 1029_h: Error Behavior

If a device failure is detected in operational state, the device can be configured to enter alternatively the stopped state or remain in the current state in case of a device failure. Device failures include the following errors:

- Communication error
- Application error

OBJECT DESCRIPTION

Index	Name	Object Code	Data Type
1029 _h	Error behavior	ARRAY	UNSIGNED8

ENTRY DESCRIPTION

Sub-Index	Description	Access	PDO Mapping	Value Range	Default Value
00 _h	Number of error classes	ro	no	2 _h	2
01 _h	Communication error	rw	no	UNSIGNED8	0 (enter stopped state)
02 _h	Application error	rw	no	UNSIGNED8	1 (remain in current state)

3.1.18 Objects 1400_h-1405_h: Receive PDO Communication Parameter

These objects contain the communication parameters for the PDOs of motor 0 the device is able to receive. The sub-index 0_h contains the number of valid entries within the communication record. Its value is at least 2.

OBJECT DESCRIPTION

Index	Name	Object Code	Data Type
1400 _h -1405 _h	Receive PDO parameter	RECORD	PDO CommPar
1400 _h	RPDO 1	RECORD	PDO CommPar
1401 _h	RPDO 2	RECORD	PDO CommPar
1402 _h	RPDO 3	RECORD	PDO CommPar
1403 _h	RPDO 4	RECORD	PDO CommPar
1405 _h	RPDO 6	RECORD	PDO CommPar

ENTRY DESCRIPTION

Sub-Index	Description	Access	PDO Mapping	Value Range	Default Value
00 _h	Largest sub-index supported	ro	no	Number of entries: 2	2
01 _h	COB-ID used by PDO	rw	no	UNSIGNED32	Index 1400 _h : 200 _h + Node-ID Index 1401 _h : 300 _h + Node-ID Index 1402 _h : 400 _h + Node-ID Index 1403 _h : 500 _h + Node-ID Index 1405 _h : 0
02 _h	Transmission type	rw	no	UNSIGNED8	Index 1400 _h : Ff _h Index 1401 _h : Ff _h Index 1402 _h : Ff _h Index 1403 _h : Ff _h Index 1405 _h : Ff _h

3.1.19 Objects 1440_h-1445_h: Receive PDO Communication Parameter

This object contains the communication parameters for the PDOs of motor 1 the device is able to receive. The sub-index 0_h contains the number of valid entries within the communication record. Its value is at least 2.

OBJECT DESCRIPTION

Index	Name	Object Code	Data Type
1440 _h -1445 _h	Receive PDO parameter	RECORD	PDO CommPar
1440 _h	RPDO 1	RECORD	PDO CommPar
1441 _h	RPDO 2	RECORD	PDO CommPar
1442 _h	RPDO 3	RECORD	PDO CommPar
1443 _h	RPDO 4	RECORD	PDO CommPar
1445 _h	RPDO 6	RECORD	PDO CommPar

ENTRY DESCRIPTION

Sub-Index	Description	Access	PDO Mapping	Value Range	Default Value
00 _h	Largest sub-index supported	ro	no	Number of entries: 2	2
01 _h	COB-ID used by PDO	rw	no	UNSIGNED32	Index 1440 _h : 0 Index 1441 _h : 0 Index 1442 _h : 0 Index 1443 _h : 0 Index 1445 _h : 0
02 _h	Transmission type	rw	no	UNSIGNED8	Index 1440 _h : Ff _h Index 1441 _h : Ff _h Index 1442 _h : Ff _h Index 1443 _h : Ff _h Index 1445 _h : Ff _h

3.1.20 Objects 1480_h-1485_h: Receive PDO Communication Parameter

These objects contain the communication parameters for the PDOs of motor 2 the device is able to receive. The sub-index 0_h contains the number of valid entries within the communication record. Its value is at least 2.

OBJECT DESCRIPTION

Index	Name	Object Code	Data Type
1400 _h -1405 _h	Receive PDO parameter	RECORD	PDO CommPar
1480 _h	RPDO 1	RECORD	PDO CommPar
1481 _h	RPDO 2	RECORD	PDO CommPar
1482 _h	RPDO 3	RECORD	PDO CommPar
1483 _h	RPDO 4	RECORD	PDO CommPar
1485 _h	RPDO 6	RECORD	PDO CommPar

ENTRY DESCRIPTION

Sub-Index	Description	Access	PDO Mapping	Value Range	Default Value
00 _h	Largest sub-index supported	ro	no	Number of entries: 2	2
01 _h	COB-ID used by PDO	rw	no	UNSIGNED32	Index 1480 _h : 0 Index 1481 _h : 0 Index 1482 _h : 0 Index 1483 _h : 0 Index 1485 _h : 0
02 _h	Transmission type	rw	no	UNSIGNED8	Index 1480 _h : Ff _h Index 1481 _h : Ff _h Index 1482 _h : Ff _h Index 1483 _h : Ff _h Index 1485 _h : Ff _h

3.1.21 Objects 1600_h-1605_h: Receive PDO Mapping

These objects contain the mapping for the PDOs of motor 0 the device is able to receive. The sub-index 0_h contains the number of valid entries within the mapping record. This number of entries is also the number of the application variables which shall be transmitted/received with the corresponding PDO. The sub-indices from 1_h to the number of entries contain the information about the mapped application variables. These entries describe the PDO contents by their index, sub-index and length. The values are hexadecimally coded.

OBJECT DESCRIPTION

Index	Name	Object Code	Data Type
1600 _h -1605 _h	Receive PDO mapping	RECORD	PDO Mapping
1600 _h	Mapping for RPDO 1	RECORD	PDO Mapping
1601 _h	Mapping for RPDO 2	RECORD	PDO Mapping
1602 _h	Mapping for RPDO 3	RECORD	PDO Mapping
1603 _h	Mapping for RPDO 4	RECORD	PDO Mapping
1605 _h	Mapping for RPDO 6	RECORD	PDO Mapping

ENTRY DESCRIPTION

Sub-Index	Description	Access	PDO Mapping	Value Range	Default Value
00 _h	Number of mapped application objects in PDO	rw	no	1... 3 0 deactivated	Index 1600 _h : 1 Index 1601 _h : 2 Index 1602 _h : 2 Index 1603 _h : 2 Index 1605 _h : 2
01 _h	Mapping entry 1	rw	no	UNSIGNED32	Index 1600 _h : 60400010 _h Index 1601 _h : 60400010 _h Index 1602 _h : 60400010 _h Index 1603 _h : 60400010 _h Index 1605 _h : 60400010 _h
02 _h	Mapping entry 2	rw	no	UNSIGNED32	Index 1600 _h : 0 Index 1601 _h : 60600008 _h Index 1602 _h : 607A0020 _h Index 1603 _h : 60FF0020 _h Index 1605 _h : 60420010 _h
03 _h	Mapping entry 3	rw	no	UNSIGNED32	Index 1600 _h : 0 Index 1601 _h : 0 Index 1602 _h : 0 Index 1603 _h : 0 Index 1605 _h : 0

3.1.22 Objects 1640_h-1645_h: Receive PDO Mapping

These objects contain the mapping for the PDOs of motor 1 the device is able to receive. The sub-index 0_h contains the number of valid entries within the mapping record. This number of entries is also the number of the application variables which shall be transmitted/received with the corresponding PDO. The sub-indices from 1_h to the number of entries contain the information about the mapped application variables. These entries describe the PDO contents by their index, sub-index and length. All three values are hexadecimal coded.

OBJECT DESCRIPTION

Index	Name	Object Code	Data Type
1640 _h -1645 _h	Receive PDO mapping	RECORD	PDO Mapping
1640 _h	Mapping for RPDO 65	RECORD	PDO Mapping
1641 _h	Mapping for RPDO 66	RECORD	PDO Mapping
1642 _h	Mapping for RPDO 67	RECORD	PDO Mapping
1643 _h	Mapping for RPDO 68	RECORD	PDO Mapping
1645 _h	Mapping for RPDO 70	RECORD	PDO Mapping

ENTRY DESCRIPTION

Sub-Index	Description	Access	PDO Mapping	Value Range	Default Value
00 _h	Number of mapped application objects in PDO	rw	no	1... 3 0 deactivated	Index 1640 _h : 1 Index 1641 _h : 2 Index 1642 _h : 2 Index 1643 _h : 2 Index 1645 _h : 2
01 _h	Mapping entry 1	rw	no	UNSIGNED32	Index 1640 _h : 68400010 _h Index 1641 _h : 68400010 _h Index 1642 _h : 68400010 _h Index 1643 _h : 68400010 _h Index 1645 _h : 68400010 _h
02 _h	Mapping entry 2	rw	no	UNSIGNED32	Index 1640 _h : 0 Index 1641 _h : 68600008 _h Index 1642 _h : 687A0020 _h Index 1643 _h : 68FF0020 _h Index 1645 _h : 68420010 _h
03 _h	Mapping entry 3	rw	no	UNSIGNED32	Index 1640 _h : 0 Index 1641 _h : 0 Index 1642 _h : 0 Index 1643 _h : 0 Index 1645 _h : 0

3.1.23 Objects 1680_h-1685_h: Receive PDO Mapping

These objects contain the mapping for the PDOs of motor 2 the device is able to receive. The sub-index 0_h contains the number of valid entries within the mapping record. This number of entries is also the number of the application variables which shall be transmitted/received with the corresponding PDO. The sub-indices from 1_h to the number of entries contain the information about the mapped application variables. These entries describe the PDO contents by their index, sub-index and length. All three values are hexadecimal coded.

OBJECT DESCRIPTION

Index	Name	Object Code	Data Type
1680 _h -1685 _h	Receive PDO mapping	RECORD	PDO Mapping
1680 _h	Mapping for RPDO 129	RECORD	PDO Mapping
1681 _h	Mapping for RPDO 130	RECORD	PDO Mapping
1682 _h	Mapping for RPDO 131	RECORD	PDO Mapping
1683 _h	Mapping for RPDO 132	RECORD	PDO Mapping
1685 _h	Mapping for RPDO 134	RECORD	PDO Mapping

ENTRY DESCRIPTION

Sub-Index	Description	Access	PDO Mapping	Value Range	Default Value
00 _h	Number of mapped application objects in PDO	rw	no	1... 3 0 deactivated	Index 1680 _h : 1 Index 1681 _h : 2 Index 1682 _h : 2 Index 1683 _h : 2 Index 1685 _h : 2
01 _h	Mapping entry 1	rw	no	UNSIGNED32	Index 1680 _h : 70400010 _h Index 1681 _h : 70400010 _h Index 1682 _h : 70400010 _h Index 1683 _h : 70400010 _h Index 1685 _h : 70400010 _h
02 _h	Mapping entry 2	rw	no	UNSIGNED32	Index 1680 _h : 0 Index 1681 _h : 70600008 _h Index 1682 _h : 707A0020 _h Index 1683 _h : 70FF0020 _h Index 1685 _h : 70420010 _h
03 _h	Mapping entry 3	rw	no	UNSIGNED32	Index 1680 _h : 0 Index 1681 _h : 0 Index 1682 _h : 0 Index 1683 _h : 0 Index 1685 _h : 0

3.1.24 Objects 1800_h-1805_h: Transmit PDO Communication Parameter

These objects contain the communication parameters for the PDOs of motor 0 the device is able to transmit.

OBJECT DESCRIPTION

Index	Name	Object Code	Data Type
1800 _h -1805 _h	Transmit PDO communication parameter	RECORD	PDO CommPar
1800 _h	TPDO 1 transmit communication parameter	RECORD	PDO CommPar
1801 _h	TPDO 2 transmit communication parameter	RECORD	PDO CommPar
1802 _h	TPDO 3 transmit communication parameter	RECORD	PDO CommPar
1803 _h	TPDO 4 transmit communication parameter	RECORD	PDO CommPar
1805 _h	TPDO 6 transmit communication parameter	RECORD	PDO CommPar

ENTRY DESCRIPTION

Sub-Index	Description	Access	PDO Mapping	Value Range	Default Value
00 _h	Largest sub-index supported	ro	no	2... 5 Number of entries: 5	5
01 _h	TPDO 1-4, 6: COB-ID	rw	no	UNSIGNED32	Index 1800 _h : 180 _h + Node-ID Index 1801 _h : 280 _h + Node-ID Index 1802 _h : 380 _h + Node-ID Index 1803 _h : 480 _h + Node-ID Index 1805 _h : 0
02 _h	Transmission type	rw	no	UNSIGNED8	Index 1800 _h : ff _h Index 1801 _h : ff _h Index 1802 _h : 1 Index 1803 _h : 1 Index 1805 _h : 1
03 _h	Inhibit time	rw	no	UNSIGNED16	0
04 _h	Compatibility entry	ro	no	UNSIGNED8	0
05 _h	Event timer	rw	no	0 not used UNSIGNED16	0

3.1.25 Objects 1840_h-1845_h: Transmit PDO Communication Parameter

These objects contain the communication parameters for the PDOs of motor 1 the device is able to transmit.

OBJECT DESCRIPTION

Index	Name	Object Code	Data Type
1840 _h -1845 _h	Transmit PDO communication parameter	RECORD	PDO CommPar
1840 _h	TPDO 65 transmit communication parameter	RECORD	PDO CommPar
1841 _h	TPDO 66 transmit communication parameter	RECORD	PDO CommPar
1842 _h	TPDO 67 transmit communication parameter	RECORD	PDO CommPar
1843 _h	TPDO 68 transmit communication parameter	RECORD	PDO CommPar
1845 _h	TPDO 70 transmit communication parameter	RECORD	PDO CommPar

ENTRY DESCRIPTION

Sub-Index	Description	Access	PDO Mapping	Value Range	Default Value
00 _h	Largest sub-index supported	ro	no	2... 5 Number of entries: 5	5
01 _h	TPDO 1-4, 6: COB-ID	rw	no	UNSIGNED32	Index 1840 _h : 0 Index 1841 _h : 0 Index 1842 _h : 0 Index 1843 _h : 0 Index 1845 _h : 0
02 _h	Transmission type	rw	no	UNSIGNED8	Index 1840 _h : ff _h Index 1841 _h : ff _h Index 1842 _h : 1 Index 1843 _h : 1 Index 1845 _h : 1
03 _h	Inhibit time	rw	no	UNSIGNED16	0
04 _h	Compatibility entry	ro	no	UNSIGNED8	0
05 _h	Event timer	rw	no	0 not used UNSIGNED16	0

3.1.26 Objects 1880_h-1885_h: Transmit PDO Communication Parameter

These objects contain the communication parameters for the PDOs of motor 2 the device is able to transmit.

OBJECT DESCRIPTION

Index	Name	Object Code	Data Type
1880 _h -1885 _h	Transmit PDO communication parameter	RECORD	PDO CommPar
1880 _h	TPDO 129 transmit communication parameter	RECORD	PDO CommPar
1881 _h	TPDO 130 transmit communication parameter	RECORD	PDO CommPar
1882 _h	TPDO 131 transmit communication parameter	RECORD	PDO CommPar
1883 _h	TPDO 132 transmit communication parameter	RECORD	PDO CommPar
1885 _h	TPDO 134 transmit communication parameter	RECORD	PDO CommPar

ENTRY DESCRIPTION

Sub-Index	Description	Access	PDO Mapping	Value Range	Default Value
00 _h	Largest sub-index supported	ro	no	2... 5 Number of entries: 5	5
01 _h	TPDO 1-4, 6: COB-ID	rw	no	UNSIGNED32	Index 1880 _h : 0 Index 1881 _h : 0 Index 1882 _h : 0 Index 1883 _h : 0 Index 1885 _h : 0
02 _h	Transmission type	rw	no	UNSIGNED8	Index 1880 _h : ff _h Index 1881 _h : ff _h Index 1882 _h : 1 Index 1883 _h : 1 Index 1885 _h : 1
03 _h	Inhibit time	rw	no	UNSIGNED16	0
04 _h	Compatibility entry	ro	no	UNSIGNED8	0
05 _h	Event timer	rw	no	0 not used UNSIGNED16	0

3.1.27 Objects 1A00_h-1A05_h: Transmit PDO Mapping Parameter

These objects contain the mapping for the PDOs the device is able to transmit.

OBJECT DESCRIPTION

Index	Name	Object Code	Data Type
1A00 _h -1A05 _h	Transmit PDO mapping parameter	RECORD	PDO mapping
1A00 _h	TPDO 1: transmit PDO mapping parameter	RECORD	PDO mapping
1A01 _h	TPDO 2: transmit PDO mapping parameter	RECORD	PDO mapping
1A02 _h	TPDO 3: transmit PDO mapping parameter	RECORD	PDO mapping
1A03 _h	TPDO 4: transmit PDO mapping parameter	RECORD	PDO mapping
1A05 _h	TPDO 6: transmit PDO mapping parameter	RECORD	PDO mapping

ENTRY DESCRIPTION

Sub-Index	Description	Access	PDO Mapping	Value Range	Default Value
00 _h	Number of mapped application objects in PDO	rw	no	0 deactivated Number of entries: 1... 3	Index 1A00 _h : 1 Index 1A01 _h : 2 Index 1A02 _h : 2 Index 1A03 _h : 2 Index 1A05 _h : 2
01 _h	Mapping entry 1	rw	no	UNSIGNED32	Index 1A00 _h : 60410010 _h Index 1A01 _h : 60410010 _h Index 1A02 _h : 60410010 _h Index 1A03 _h : 60410010 _h Index 1A05 _h : 60410010 _h
02 _h	Mapping entry 2	rw	no	UNSIGNED32	Index 1A00 _h : 0 Index 1A01 _h : 60610008 _h Index 1A02 _h : 60640020 _h Index 1A03 _h : 606c0020 _h Index 1A05 _h : 60440010 _h
03 _h	Mapping entry 3	rw	no	UNSIGNED32	Index 1A00 _h : 0 Index 1A01 _h : 0 Index 1A02 _h : 0 Index 1A03 _h : 0 Index 1A05 _h : 0

3.1.28 Objects 1A40_h-1A45_h: Transmit PDO Mapping Parameter

These objects contain the mapping for the PDOs of motor 1 the device is able to transmit.

OBJECT DESCRIPTION

Index	Name	Object Code	Data Type
1A40 _h -1A45 _h	Transmit PDO mapping parameter	RECORD	PDO mapping
1A40 _h	TPDO 65: transmit PDO mapping parameter	RECORD	PDO mapping
1A41 _h	TPDO 66: transmit PDO mapping parameter	RECORD	PDO mapping
1A42 _h	TPDO 67: transmit PDO mapping parameter	RECORD	PDO mapping
1A43 _h	TPDO 68: transmit PDO mapping parameter	RECORD	PDO mapping
1A45 _h	TPDO 70: transmit PDO mapping parameter	RECORD	PDO mapping

ENTRY DESCRIPTION

Sub-Index	Description	Access	PDO Mapping	Value Range	Default Value
00 _h	Number of mapped application objects in PDO	rw	no	0 deactivated Number of entries: 1... 3	Index 1A40 _h : 1 Index 1A41 _h : 2 Index 1A42 _h : 2 Index 1A43 _h : 2 Index 1A45 _h : 2
01 _h	Mapping entry 1	rw	no	UNSIGNED32	Index 1A40 _h : 68410010 _h Index 1A41 _h : 68410010 _h Index 1A42 _h : 68410010 _h Index 1A43 _h : 68410010 _h Index 1A45 _h : 68410010 _h
02 _h	Mapping entry 2	rw	no	UNSIGNED32	Index 1A40 _h : 0 Index 1A41 _h : 68610008 _h Index 1A42 _h : 68640020 _h Index 1A43 _h : 686c0020 _h Index 1A45 _h : 68440010 _h
03 _h	Mapping entry 3	rw	no	UNSIGNED32	Index 1A40 _h : 0 Index 1A41 _h : 0 Index 1A42 _h : 0 Index 1A43 _h : 0 Index 1A45 _h : 0

3.1.29 Objects 1A80_h-1A85_h: Transmit PDO Mapping Parameter

These objects contain the mapping for the PDOs of motor 2 the device is able to transmit.

OBJECT DESCRIPTION

Index	Name	Object Code	Data Type
1A80 _h -1A85 _h	Transmit PDO mapping parameter	RECORD	PDO mapping
1A80 _h	TPDO 129: transmit PDO mapping parameter	RECORD	PDO mapping
1A81 _h	TPDO 130: transmit PDO mapping parameter	RECORD	PDO mapping
1A82 _h	TPDO 131: transmit PDO mapping parameter	RECORD	PDO mapping
1A83 _h	TPDO 132: transmit PDO mapping parameter	RECORD	PDO mapping
1A85 _h	TPDO 134: transmit PDO mapping parameter	RECORD	PDO mapping

ENTRY DESCRIPTION

Sub-Index	Description	Access	PDO Mapping	Value Range	Default Value
00 _h	Number of mapped application objects in PDO	rw	no	0 deactivated Number of entries: 1... 3	Index 1A80 _h : 1 Index 1A81 _h : 2 Index 1A82 _h : 2 Index 1A83 _h : 2 Index 1A85 _h : 2
01 _h	Mapping entry 1	rw	no	UNSIGNED32	Index 1A80 _h : 70410010 _h Index 1A81 _h : 70410010 _h Index 1A82 _h : 70410010 _h Index 1A83 _h : 70410010 _h Index 1A85 _h : 70410010 _h
02 _h	Mapping entry 2	rw	no	UNSIGNED32	Index 1A80 _h : 0 Index 1A81 _h : 70610008 _h Index 1A82 _h : 70640020 _h Index 1A83 _h : 706c0020 _h Index 1A85 _h : 70440010 _h
03 _h	Mapping entry 3	rw	no	UNSIGNED32	Index 1A80 _h : 0 Index 1A81 _h : 0 Index 1A82 _h : 0 Index 1A83 _h : 0 Index 1A85 _h : 0

4 Device Profile Objects (CiA402) and Modes of Operation

The PDS (power drive system) behavior depends on the activated mode of operation. The PDS implements several modes of operation. Since it is not possible to operate the modes in parallel, the user is able to activate the required function by selecting a mode of operation.

The control device writes to the *modes of operation* object in order to select the operation mode. The drive device provides the *modes of operation display* object to indicate the actual activated operation mode. Controlword, statusword, and set-points are used mode-specific. This implies the responsibility of the control device to avoid inconsistencies and erroneous behavior.

THE FOLLOWING OPERATION MODES CAN BE CHOSEN:

- Profile position mode
- Homing mode
- Velocity mode
- Profile velocity mode

Please refer to object 6060_h (section 4.1.6) for information about how to choose an operation mode.

4.1 Detailed Object Specifications

4.1.1 Object 605A_h, 685A_h, and 705A_h: Quick Stop Option Code

This object indicates what action is performed when the quick stop function is executed. The slow down ramp is the deceleration value of the used mode of operations. The following quick stop option codes are supported in the current version of the CANopen firmware:

VALUE DEFINITION

Value	Definition
1	Slow down on <i>slow down ramp</i> and transit into <i>switch on disabled</i>
2	Slow down on <i>quick stop ramp</i> and transit into <i>switch on disabled</i>
5	Slow down on <i>slow down ramp</i> and stay in <i>quick stop active</i>
6	Slow down on <i>quick stop ramp</i> and stay in <i>quick stop active</i>

OBJECT DESCRIPTION

Index	Name	Object Code	Data Type
605A _h (motor 0)	Quick stop option code	Variable	SIGNED16
685A _h (motor 1)			
705A _h (motor 2)			

ENTRY DESCRIPTION

Sub-Index	Access	PDO Mapping	Value Range	Default Value
00 _h	rw	Refer to CiA402-3	See value definition above	2

4.1.2 Object 605B_h, 685B_h, and 705B_h: Shutdown Option Code

This object indicates what action is performed if there is a transition from *operation enabled state* to *ready to switch on state*. The slow down ramp is the deceleration value of the used mode of operations. The shutdown option code always has the value 0 as only this is supported.

VALUE DEFINITION

Value	Definition
0	Disable <i>drive function</i> (switch-off the drive power stage)

OBJECT DESCRIPTION

Index	Name	Object Code	Data Type
605B _h (motor 0)	Shutdown option code	Variable	UNSIGNED16
685B _h (motor 1)			
705B _h (motor 2)			

ENTRY DESCRIPTION

Sub-Index	Access	PDO Mapping	Value Range	Default Value
00 _h	r0	Refer to CiA402-3	See value definition above	0

4.1.3 Object 605C_h, 685C_h, and 705C_h: Disable Operation Option Code

These objects indicate what action is performed if there is a transition from *operation enabled state* to *switched on state*. The disable operation option code always has the value 1 as only this is supported. The slow down ramp is the deceleration value of the used mode of operation.

VALUE DEFINITION

Value	Definition
1	Slow down with <i>slow down ramp</i> ; disable of the <i>drive function</i>

OBJECT DESCRIPTION

Index	Name	Object Code	Data Type
605C _h (motor 0)	Disable operation option code	Variable	UNSIGNED16
685C _h (motor 1)			
705C _h (motor 2)			

ENTRY DESCRIPTION

Sub-Index	Access	PDO Mapping	Value Range	Default Value
00 _h	ro	Refer to CiA402-3	See value definition above	1

4.1.4 Object 605D_h, 685D_h, and 705D_h: Halt Option Code

This object indicates what action is performed when the halt function is executed. The slow down ramp is the deceleration value of the used mode of operation. The halt option code always has the value 1 as only this is supported.

VALUE DEFINITION

Value	Definition
1	Slow down on <i>slow down ramp</i> and stay in <i>operation enabled</i>

OBJECT DESCRIPTION

Index	Name	Object Code	Data Type
605D _h (motor 0)	Halt option code	Variable	UNSIGNED16
685D _h (motor 1)			
705D _h (motor 2)			

ENTRY DESCRIPTION

Sub-Index	Access	PDO Mapping	Value Range	Default Value
00 _h	r0	Refer to CiA402-3	See value definition above.	1

4.1.5 Object 605E_h, 685E_h, and 705E_h: Fault Reaction Option Code

This object indicates what action is performed when fault is detected in the power drive system. The slow down ramp is the deceleration value of the used mode of operation. The fault reaction option code always has the value 2 as only this is supported.

VALUE DEFINITION

Value	Definition
2	Slow down on <i>quick stop ramp</i>

OBJECT DESCRIPTION

Index	Name	Object Code	Data Type
605E _h (motor 0) 685E _h (motor 1) 705E _h (motor 2)	Fault reaction option code	Variable	UNSIGNED16

ENTRY DESCRIPTION

Sub-Index	Access	PDO Mapping	Value Range	Default Value
00 _h	r0	Refer to CiA402-3	See value definition above	2

4.1.6 Object 6060_h, 6860_h, and 7060_h: Modes of Operation

This object indicates the requested operation mode. Supported operating modes are:

VALUE DEFINITION

Value	Definition
0	No mode*
1	Profile position mode
2	Velocity mode
3	Profile velocity mode
6	Homing mode

* A motor will not run when the operating mode is set to 0. It will be stopped when the motor is running in one of the supported operating modes and the operating mode is then switched to 0.

OBJECT DESCRIPTION

Index	Name	Object Code	Data Type
6060 _h (motor 0) 6860 _h (motor 1) 7060 _h (motor 2)	Modes of operation	Variable	SIGNED8

ENTRY DESCRIPTION

Sub-Index	Access	PDO Mapping	Value Range	Default Value
00 _h	rw	Refer to CiA402-3	See value definition above	0

4.1.7 Object 6061_h, 6861_h, and 7061_h: Modes of Operation Display

This object shows the operating mode that is set.

VALUE DEFINITION

Value	Definition
0	No mode*
1	Profile position mode
2	Velocity mode
3	Profile velocity mode
6	Homing mode

* The motor will not run when the operating mode is set to 0. It will be stopped when the motor is running in one of the supported operating modes and the operating mode is then switched to 0.

OBJECT DESCRIPTION

Index	Name	Object Code	Data Type
6061 _h (motor 0) 6861 _h (motor 1) 7061 _h (motor 2)	Modes of operation display	Variable	SIGNED8

ENTRY DESCRIPTION

Sub-Index	Access	PDO Mapping	Value Range	Default Value
00 _h	ro	Refer to CiA402-3	See value definition above	0

4.1.8 Object 606A_h, 686A_h, and 706A_h: Sensor Selection Code

This object provides the source of the velocity sensor actual value. It selects whether an encoder is to be used or not.

VALUE DEFINITION

Value	Definition
0	Encoder used
-1	No encoder

OBJECT DESCRIPTION

Index	Name	Object Code	Data Type
606A _h (motor 0) 686A _h (motor 1) 706A _h (motor 2)	Sensor selection code	Variable	SIGNED16

ENTRY DESCRIPTION

Sub-Index	Access	PDO Mapping	Value Range	Default Value
00 _h	rw	Refer to CiA402-3	See value definition above.	-1

4.1.9 Object 6085_h, 6885_h, and 7085_h: Quick Stop Deceleration

These objects indicate the configured deceleration used to stop a motor when the *quick stop function* is activated and the *quick stop code object* (605A_h/685A_h/705A_h) is set to 2 [or 6]. The value is given in the same unit as *profile acceleration object* 6083_h. The units can be chosen with objects 208E_h/228E_h/248E_h, described in paragraph 0. The objects 208E_h/228E_h/248E_h read 0 when internal units are selected or 179 when user units (PPS/s) are selected.

OBJECT DESCRIPTION

Index	Name	Object Code	Data Type
6085 _h (motor 0) 6885 _h (motor 1) 7085 _h (motor 2)	Quick stop deceleration	Variable	UNSIGNED32

ENTRY DESCRIPTION

Sub-Index	Access	PDO Mapping	Value Range	Default Value
00 _h	rw	Refer to CiA402-3	UNSIGNED32	1000

4.1.10 Object 608F_h, 688F_h, and 708F_h: Position Encoder Resolution

These objects define the resolution of the encoder. The position encoder resolution is calculated by the following formula:

$$\text{position encoder resolution} = \frac{\text{encoder increments}}{\text{motor revolutions}}$$

All values are dimensionless.

OBJECT DESCRIPTION

Index	Name	Object Code	Data Type
608F _h (motor 0) 688F _h (motor 1) 708F _h (motor 2)	Encoder resolution	Array	UNSIGNED32

ENTRY DESCRIPTION

Sub-Index	Description	Entry category	Access	PDO Mapping	Value Range	Default Value
00 _h	Highest sub index supported	Mandatory	c	Refer to CiA402	02 _h	2
01 _h	Encoder increments	Mandatory	rw	Refer to CiA402	UNSIGNED32	1
02 _h	Motor revolutions	Mandatory	ro	Refer to CiA402	UNSIGNED32	2

4.1.11 Object 60C5_h, 68C5_h, and 70C5_h: Max Acceleration

This object indicates the configured maximal acceleration. It is used to limit the acceleration to an acceptable value in order to prevent the motor and the moved mechanics from being destroyed. It is given in internal or user specific units (depending on object 208C_h, paragraph 5.1.18, object 2087_h and object 2088_h, paragraph 5.1.16 and paragraph 5.1.17).

OBJECT DESCRIPTION

Index	Name	Object Code	Data Type
60C5 _h (motor 0) 68C5 _h (motor 1) 70C5 _h (motor 2)	Max acceleration	Variable	UNSIGNED32

ENTRY DESCRIPTION

Sub-Index	Access	PDO Mapping	Value Range	Default Value
00 _h	ro	Refer to CiA402-3	UNSIGNED32	Depends on the units

4.1.12 Object 60C_h, 68C_h, and 70C_h: Max Deceleration

This object indicates the configured maximal deceleration. It is used to limit the acceleration to an acceptable value in order to prevent the motor and the moved mechanics from being destroyed. The max deceleration is given in internal or user specific units (depending on object 208C_h, paragraph 5.1.18, object 2087_h and object 2088_h, paragraph 5.1.16 and paragraph 5.1.17). Object 60C_h has the same unit as the max acceleration object 60C5_h.

OBJECT DESCRIPTION

Index	Name	Object Code	Data Type
60C _h (motor 0)	Max deceleration	Variable	UNSIGNED32
68C _h (motor 1)			
70C _h (motor 2)			

ENTRY DESCRIPTION

Sub-Index	Access	PDO Mapping	Value Range	Default Value
00 _h	ro	Refer to CiA402-3	UNSIGNED32	Depends on the units

4.1.13 Object 60FD_h, 68FD_h, and 70FD_h: Digital Inputs

This object contains the states of the digital inputs of the module. Starting from bit 0, every bit reflects the state of one digital input. The number of valid bits depends on the number of digital inputs on the module used.

VALUE DEFINITION

Value	Definition
0 _b	Switched off
1 _b	Switched on

OBJECT DESCRIPTION

Index	Name	Object Code	Data Type
60FD _h (motor 0)	Digital inputs	Variable	UNSIGNED32
68FD _h (motor 1)			
70FD _h (motor 2)			

ENTRY DESCRIPTION

Sub-Index	Access	PDO Mapping	Value Range	Default Value
00 _h	r0	Refer to CiA402-3	UNSIGNED32	0000 0000 _h

4.1.14 Object 6502_h, 6D02_h, and 7502_h: Supported Drive Modes

00000025_h, which means that the following modes are provided by the drive:

- 0 = no mode
- 1 = profile position mode
- 2 = velocity mode
- 3 = profile velocity mode
- 6 = homing mode

OBJECT DESCRIPTION

Index	Name	Object Code	Data Type
6502 _h (motor 0)	Supported drive modes	Variable	UNSIGNED32
6D02 _h (motor 1)			
7502 _h (motor 2)			

ENTRY DESCRIPTION

Sub-Index	Access	PDO Mapping	Value Range	Default Value
00 _h	r0	Refer to CiA402-3	See above	00000025 _h

4.2 Profile Position Mode

A target position is applied to the trajectory generator. It is generating a position-demand-value for the position control loop described in the position control function.

Please refer to objects 6060_h/6860_h/7060_h (section 4.1.6) for information about how to choose an operation mode. Object 6061_h/6861_h/7061_h (section 4.1.7) show the operation mode for each motor that is set.

4.2.1 Detailed object specifications

The following text offers detailed object specifications. For a better understanding, it is necessary to see how the state machine works.

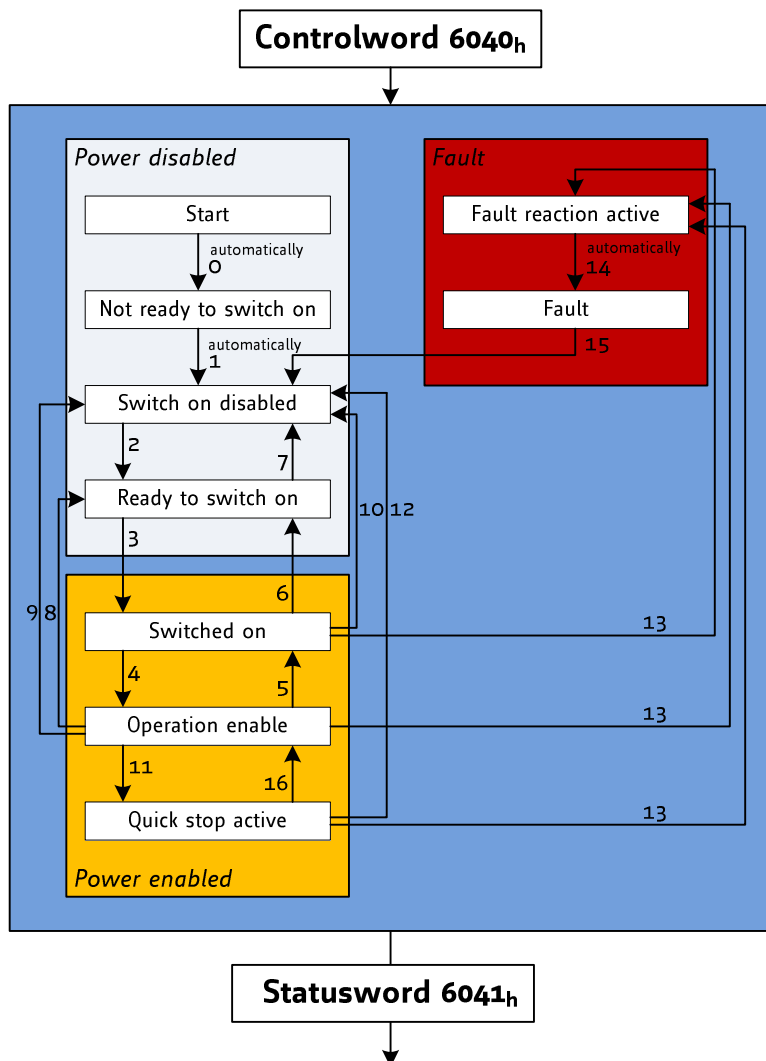

Figure 4.1 Finite state machine

NOTES ON STATE TRANSITIONS

- Commands directing a change in state are processed completely and the new state achieved before additional state change commands are processed.
- Transitions 0 and 1 occur automatically at drive power-on or reset. Transition 14 occurs automatically, too. All other state changes must be directed by the host.
- Drive function disabled indicates that no current is being supplied to the motor.
- Drive function enabled indicates that current is available for the motor and profile position and profile velocity reference values may be processed.

4.2.1.1 Object 6040_n, 6840_n, and 7040_n: Controlword

The controlword indicates the received command controlling the power drive system finite state automation (PDS FSA). The CiA-402 state machine can be controlled using this object. Please refer to *Figure 4.1 Finite state machine* for detailed information.

STRUCTURE OF CONTROLWORD / VALUE DEFINITION

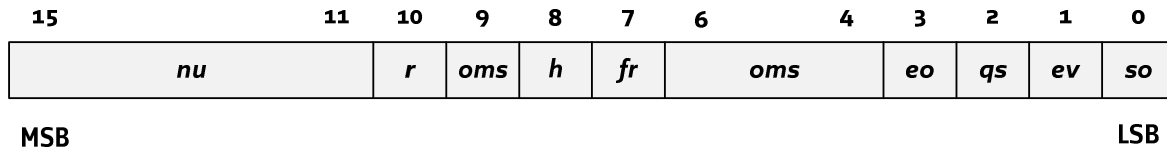

LEGEND: nu = not used; r = reserved; oms = operation mode specific; h = halt; fr = fault reset; eo = enable operation; qs = quick stop; ev = enable voltage; so = switch on

OPERATION MODE SPECIFIC BITS IN PP MODE

Bit	Name	Definition
4	New set point	0-to-1: The next positioning will be started after the last one has completed.
5	Change immediately	Not supported
6	Absolute/relative	0 = new position is absolute; 1 = new position is relative
9	Change set point	Not supported

COMMAND CODING

Command	Bits of controlword					Transitions
	Bit 7	Bit 3	Bit 2	Bit 1	Bit 0	
Shutdown	0	x	1	1	0	2, 6, 8
Switch on	0	0	1	1	1	3
Switch on + enable operation	0	1	1	1	1	3 + 4 (NOTE)
Disable voltage	0	x	x	0	x	7, 9, 10, 12
Quick stop	0	x	0	1	x	7, 10, 11
Disable operation	0	0	1	1	1	5
Enable operation	0	1	1	1	1	4, 16
Fault reset	↑	x	x	x	x	15

OBJECT DESCRIPTION

Index	Name	Object Code	Data Type
6040 _n (motor 0) 6840 _n (motor 1) 7040 _n (motor 2)	Controlword	Variable	UNSIGNED16

ENTRY DESCRIPTION

Sub-Index	Access	PDO Mapping	Value Range	Default Value
00 _n	rw	Refer to CiA402-3	See command coding above	<i>Device and operation mode specific</i>

4.2.1.2 Object 6041_h, 6841_h, and 7041_h: Statusword

The statusword provides the status of the PDS FSA. It reflects the status of the CiA402 state machine. Please refer to *Figure 4.1 Finite state machine* for detailed information. The object is structured as defined below.

For more information about the coding refer to the *CANopen Drives and motion control device profile, part 2* please.

STRUCTURE OF STATUSWORD / VALUE DEFINITION

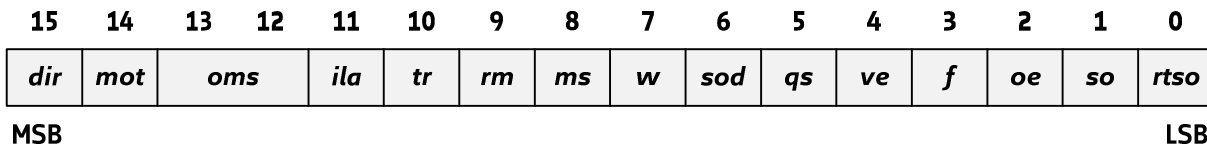

LEGEND: *dir* = direction; *mot* = motor activity; *oms* = operation mode specific; *ila* = internal limit active; *tr* = target reached; *rm* = remote; *ms* = manufacturer specific; *w* = warning; *sod* = switch on disabled; *qs* = quick stop; *ve* = voltage enabled; *f* = fault; *oe* = operation enabled; *so* = switched on; *rtso* = ready to switch on

TRINAMIC SPECIFIC BITS

Bit	Name	Definition
14	Motor activity	0 = motor stop; 1 = motor rotates
15	Direction of rotation	This bit determines/shows the direction of rotation

OPERATION MODE SPECIFIC BITS IN PP MODE

Bit	Name	Definition
10	Target reached	Set when the motor is within the target position window
12	Set point acknowledge	0 = set point processed; 1 = set point still in process
13	Following error	Not supported

STATE CODING

Statusword	PDS FSA state
xxxx xxxx x0xx 0000 _b	Not ready to switch on
xxxx xxxx x1xx 0000 _b	Switch on disabled
xxxx xxxx x01x 0001 _b	Ready to switch on
xxxx xxxx x01x 0011 _b	Switched on
xxxx xxxx x01x 0111 _b	Operation enabled
xxxx xxxx x00x 0111 _b	Quick stop active
xxxx xxxx x0xx 1111 _b	Fault reaction active
xxxx xxxx x0xx 1000 _b	Fault

OBJECT DESCRIPTION

Index	Name	Object Code	Data Type
6041 _h (motor 0)	Statusword	Variable	UNSIGNED16
6841 _h (motor 1)			
7041 _h (motor 2)			

ENTRY DESCRIPTION

Sub-Index	Access	PDO Mapping	Value Range	Default Value
00 _h	ro	Refer to CiA402-3	See state coding above	no

4.2.1.3 Object 6062_h, 6862_h, and 7062_h: Position Demand Value

These objects provide the demanded position value. The value is given in microsteps. The *position demand value* indicates the actual position that the motor should have. It is not to be confused with the *position actual internal value* (objects 6063_h/6863_h/7063_h) and *position actual value* (objects 6064_h/6864_h/7064_h).

OBJECT DESCRIPTION

Index	Name	Object Code	Data Type
6062 _h (motor 0) 6862 _h (motor 1) 7062 _h (motor 2)	Position demand value	Variable	SIGNED32

ENTRY DESCRIPTION

Sub-Index	Access	PDO Mapping	Value Range	Default Value
00 _h	ro	Refer to CiA402-3	SIGNED32	no

4.2.1.4 Object 6063_h, 6863_h, and 7063_h: Position Actual Internal Value

These objects provide the actual value of an encoder or a motor. Please use the *sensor selection objects* (see paragraph 4.1.8) for selecting the specific motor or the encoder first. The *position actual internal value* indicates the actual position of an encoder or a motor re-scaled to the microstep resolution. The value is given in microsteps.

OBJECT DESCRIPTION

Index	Name	Object Code	Data Type
6063 _h (motor 0) 6863 _h (motor 1) 7063 _h (motor 2)	Position actual internal value	Variable	SIGNED32

ENTRY DESCRIPTION

Sub-Index	Access	PDO Mapping	Value Range	Default Value
00 _h	ro	Refer to CiA402-3	SIGNED32	no

4.2.1.5 Object 6064_h, 6864_h, and 7064_h: Position Actual Value

These objects provide the actual value of a position measurement device. They always contain the same value as the related *position actual internal value* objects (6063_h/6863_h/7063_h).

OBJECT DESCRIPTION

Index	Name	Object Code	Data Type
6064 _h (motor 0) 6864 _h (motor 1) 7064 _h (motor 2)	Position actual value	Variable	SIGNED32

ENTRY DESCRIPTION

Sub-Index	Access	PDO Mapping	Value Range	Default Value
00 _h	ro	Refer to CiA402-3	SIGNED32	no

4.2.1.6 Object 6065_h, 6865_h, and 7065_h: Following Error Window

This object indicates the configured range of tolerated position values symmetrically to the position demand value. If the position actual value is out of the following error window, a following error occurs. A following error may occur when a drive is blocked, e.g., unreachable profile velocity occurs. The value is given in microsteps. If the value of the following error window is 0 or FFFF FFFF_h, the following control will be switched off.

When the difference between motor position (object 6062_h) and encoder position (object 6063_h or 6064_h) is greater than the value set here, the motor will be stopped and an emergency message will be sent. Setting this object to zero will turn off this feature completely.

Setting this object to a too low value will lead to false alarms.

OBJECT DESCRIPTION

Index	Name	Object Code	Data Type
6065 _h (motor 0) 6865 _h (motor 1) 7065 _h (motor 2)	Following error window	Variable	UNSIGNED32

ENTRY DESCRIPTION

Sub-Index	Access	PDO Mapping	Value Range	Default Value
00 _h	rw	Refer to CiA402-3	UNSIGNED32	0... 8388607

4.2.1.7 Object 6067_h, 6867_h, and 7067_h: Position Window

This object indicates the configured symmetrical range of accepted positions relative to the target position. If the value of the actual position is within the position window, this target position is regarded as having been reached. The value is given in microsteps. If the value of the position window is FFFF FFFF_h, the position window control is switched off.

If this object is set to zero, the target reached event will be signaled when the demand position (6062_h) has reached the target position (607A_h).

When the position window is set to a value greater than zero, the target reached event will be signaled when the actual position value (6064_h) is within the (target position – position window) and (target position + position window).

OBJECT DESCRIPTION

Index	Name	Object Code	Data Type
6067 _h (motor 0) 6867 _h (motor 1) 7067 _h (motor 2)	Position window	Variable	UNSIGNED32

ENTRY DESCRIPTION

Sub-Index	Access	PDO Mapping	Value Range	Default Value
00 _h	rw	Refer to CiA402-3	UNSIGNED32	0... 8388607

4.2.1.8 Object 6068_n, 6868_n, and 7068_n: Position Window Time

This object indicates the configured time, during which the actual position within the position window is measured. The value is given in ms. If this object is set to a value greater than zero and also the position window (6067_n) is set to a value greater than zero the target reached event will not be signaled until the actual position (6064_n) is at least as many milliseconds within the position window as defined by this object.

OBJECT DESCRIPTION

Index	Name	Object Code	Data Type
6068 _n (motor 0)	Position window time	Variable	UNSIGNED16
6868 _n (motor 1)			
7068 _n (motor 2)			

ENTRY DESCRIPTION

Sub-Index	Access	PDO Mapping	Value Range	Default Value
00 _h	rw	Refer to CiA402-3	UNSIGNED16	0

4.2.1.9 Object 606C_h, 686C_h, and 706C_h: Velocity Actual Value

These objects give the actual velocity value derived either from a velocity sensor or from a position sensor of the related motor.

OBJECT DESCRIPTION

Index	Name	Object Code	Data Type
606C _h	Velocity actual value	Variable	INTEGER32
686C _h			
706C _h			

ENTRY DESCRIPTION

Sub-Index	Access	PDO Mapping	Value Range	Default Value
00 _h	ro	Refer to CiA402-3	INTEGER32	no

4.2.1.10 Object 607A_h, 687A_h, and 707A_h: Target Position

The target position is the position that the drive should move to in profile position mode using the current settings of motion control parameters (such as velocity, acceleration, deceleration, motion profile type etc.). The value of these objects is interpreted as absolute or relative depending on the *abs/rel* flag in the controlword. It is given in microsteps.

OBJECT DESCRIPTION

Index	Name	Object Code	Data Type
607A _h (motor 0)	Target position	Variable	SIGNED32
687A _h (motor 1)			
707A _h (motor 2)			

ENTRY DESCRIPTION

Sub-Index	Access	PDO Mapping	Value Range	Default Value
00 _h	rw	Refer to CiA402-3	SIGNED32	-2147483647... +2147483647

4.2.1.11 Object 607D_h, 687D_h, and 707D_h: Software Position Limit

This object indicates the configured maximal and minimal software position limits. These parameters define the absolute position limits for the *position demand value* (6062_h) and the *position actual value* (6064_h). Every new target position is checked against these limits. The limit positions are always relative to the machine home position. Before being compared with the *target position* (607A_h), they are corrected internally by the *home offset* as follows:

Corrected min position limit = min position limit – home offset
 Corrected max position limit = max position limit – home offset

The limit positions are given in microsteps (same as target position). Two limits for moving the motor in positioning mode can be set here. It will then not be possible to leave this window.

OBJECT DESCRIPTION

Index	Name	Object Code	Data Type
607D _h (motor 0)	Software position limit	Array	SIGNED32
687D _h (motor 1)			
707D _h (motor 2)			

ENTRY DESCRIPTION

Sub-Index	Description	Entry category	Access	PDO Mapping	Value Range	Default Value
01 _h	Min position limit	Mandatory	rw	Refer to CiA402-3	SIGNED32	-2147483647
02 _h	Max position limit	Mandatory	rw	Refer to CiA402-3	SIGNED32	+2147483647

4.2.1.12 Object 607F_h, 687F_h, and 707F_h: Maximum Profile Velocity

This object indicates the configured maximal allowed velocity in either direction during a profiled motion. It is the maximum velocity that can be used for positioning. The value is given in internal or user specific units (depending on object 208C_h, paragraph 5.1.18).

OBJECT DESCRIPTION

Index	Name	Object Code	Data Type
607F _h (motor 0)	Maximum profile velocity	Variable	UNSIGNED32
687F _h (motor 1)			
707F _h (motor 2)			

ENTRY DESCRIPTION

Sub-Index	Access	PDO Mapping	Value Range	Default Value
00 _h	ro	Refer to CiA402-3	UNSIGNED32	2047

4.2.1.13 Object 6081_h, 6881_h, and 7081_h: Profile Velocity

This object indicates the configured velocity normally attained at the end of the acceleration ramp during a profiled motion and is valid for both directions of motion. The profile velocity is the maximum velocity used when driving to a new position. It is given in internal or user specific units (depending on object 208C_h, paragraph 5.1.18)

OBJECT DESCRIPTION

Index	Name	Object Code	Data Type
6081 _h (motor 0)	Profile velocity	Variable	UNSIGNED32
6881 _h (motor 1)			
7081 _h (motor 2)			

ENTRY DESCRIPTION

Sub-Index	Access	PDO Mapping	Value Range	Default Value
00 _h	rw	Refer to CiA402-3	UNSIGNED32	1000

4.2.1.14 Object 6083_h, 6883_h, and 7083_h: Profile Acceleration

This object indicates the configured acceleration. Object 6083_h sets the maximum acceleration to be used in profile positioning mode.

Please choose the units for object 6083_h with object 208E_h, described in paragraph 5.1.19. Object 208E_h reads 0 when internal units are selected or 179 when user units (PPS/s) are selected.

OBJECT DESCRIPTION

Index	Name	Object Code	Data Type
6083 _h (motor 0)	Profile acceleration	Variable	UNSIGNED32
6883 _h (motor 1)			
7083 _h (motor 2)			

ENTRY DESCRIPTION

Sub-Index	Access	PDO Mapping	Value Range	Default Value
00 _h	rw	Refer to CiA402-3	UNSIGNED32	1000

4.2.1.15 Object 6084_h, 6884_h, and 7084_h: Profile Deceleration

This object indicates the configured deceleration. It sets the maximum deceleration used in profile positioning mode.

Please choose the units for object 6084_h with object 208E_h, described in paragraph 5.1.19. Object 208E_h reads 0 when internal units are selected or 179 when user units (PPS/s) are selected. The deceleration corresponds to the acceleration.

OBJECT DESCRIPTION

Index	Name	Object Code	Data Type
6084 _h (motor 0)	Profile deceleration	Variable	UNSIGNED32
6884 _h (motor 1)			
7084 _h (motor 2)			

ENTRY DESCRIPTION

Sub-Index	Access	PDO Mapping	Value Range	Default Value
00 _h	rw	Refer to CiA402-3	UNSIGNED32	1000

4.2.1.16 Object 6086_h, 6886_h, and 7086_h: Motion Profile Type

These objects indicate the configured type of motion profile used to perform a profiled motion. Set these objects to 0 for trapezoid ramps. Only sub-index 00_h is supported.

VALUE DEFINITION

Value	Definition
0	Linear ramp, trapezoidal profile

OBJECT DESCRIPTION

Index	Name	Object Code	Data Type
6086 _h (motor 0)	Motion profile type	Variable	UNSIGNED16
6886 _h (motor 1)			
7086 _h (motor 2)			

ENTRY DESCRIPTION

Sub-Index	Access	PDO Mapping	Value Range	Default Value
00 _h	rw	Refer to CiA402-3	0	0

4.2.2 How to move a motor in *pp* mode

Here is a little example that shows how to get a motor running in *pp* mode. In this little example we assume that the module has been reset (and then switched to pre-operational or operational) by NMT commands before. **Please note, that the values are decimal.**

- If you do not have any limit switches connected, first disable the limit switch inputs by writing 3 to object 2005_h.
- Select *pp* mode by writing 1 to object 6060_h.
- Write 6 to object 6040_h to switch to READY_TO_SWITCH_ON state.
- Write 7 to object 6040_h to switch to SWITCHED_ON state.
- Write 15 to object 6040_h to switch to OPERATION_ENABLED state.
- Write the desired target position (e.g. 500000) to object 607A_h.
- Mark the new target position as active by writing 31 to object 6040_h. The motor starts moving now.
- Reset the activation by writing 15 to object 6040_h (this can be done while the motor is still moving).

4.3 Homing Mode

This clause describes the method by which a drive seeks the home position (reference point). There are various methods of achieving this using limit switches at the ends of travel or a home switch in mid-travel. Some methods also use the index (zero) pulse train from an incremental encoder. The user may specify the speeds, acceleration and the method of homing.

There is no output data except for those bits in the statusword, which return the status or result of the homing process and the demand to the position control loops.

There are four sources of the homing signal available: these are positive and negative limit switches, the home switch and the index pulse from an encoder.

Figure 4.2 shows the defined input objects as well as the output objects. The user can specify the speeds, acceleration and method of homing. The home offset object 607C_h allows displacing zero in the coordinate system for the home position.

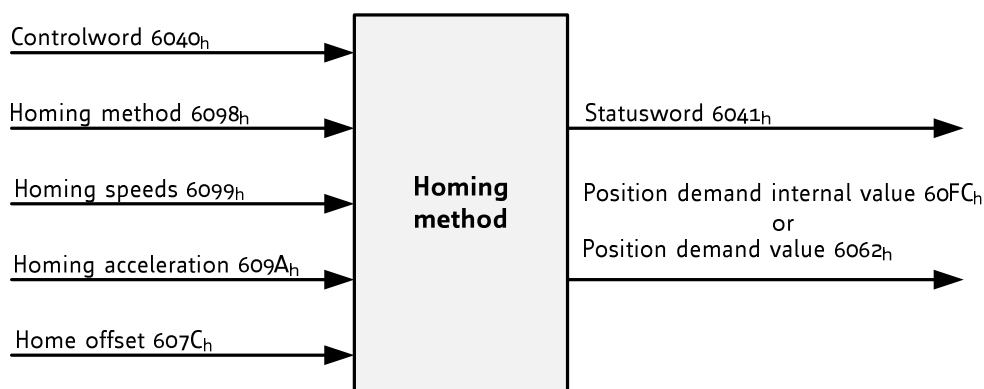

Figure 4.2 Homing mode function (motor 0)

BY CHOOSING A HOMING METHOD, THE FOLLOWING IS DETERMINED:

- the homing signal (positive limit switch, negative limit switch, and home switch),
- the direction of actuation and where appropriate, and
- the position of the index pulse.

The home position and the zero position are offset by the home offset (see object 607C_h).

THERE ARE FOUR SOURCES OF HOMING SIGNAL AVAILABLE:

- negative and positive limit switches
- home switch
- index pulse of an encoder

For the operation of positioning drives, an exact knowledge of the absolute position is normally required. Since for cost reasons drives often do not have an absolute encoder, a homing operation is necessary.

Please refer to objects 6060_h/6860_h/7060_h (section 4.1.6) for information about how to choose an operation mode. Objects 6061_h/6861_h/7061_h (section 4.1.7) show the operation modes that are set for each motor.

4.3.1 Connecting home switch, left switch, and right switch

First of all it is necessary to connect the switches. The tables and figures below will show you the right way.

4.3.1.1 TMCM-341/342/343

The 68-pin connector provides communication to a host, configuration of the EEPROM and connection of SPI drivers as well as connection of reference switches. Pin 1 of this connector is located in the lower left corner on the top site, while the connector is pointing towards the user.

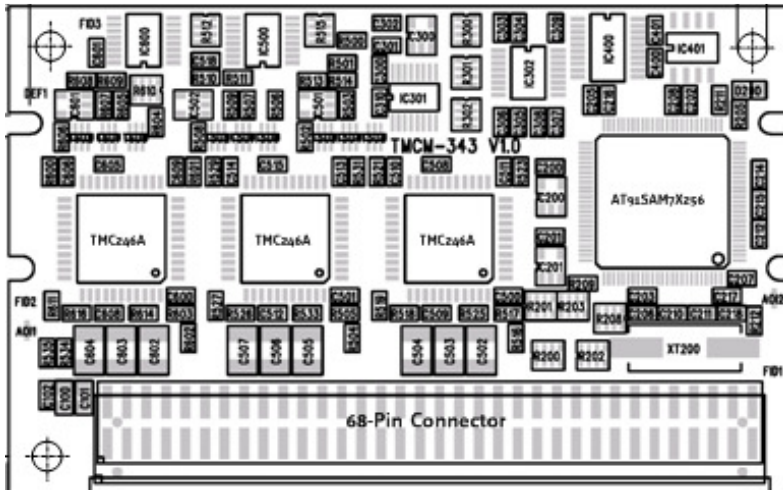

Figure 4.3: 68-pin connector of the TMCM-34x

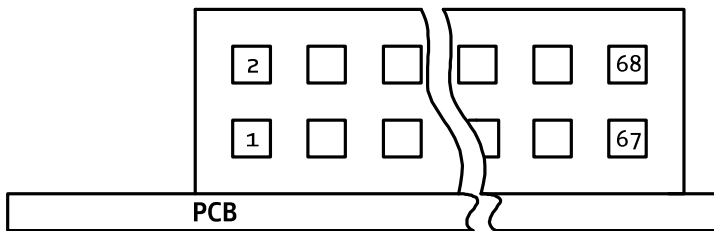

Figure 4.4: Pin order of the connector

Please connect home switch, left switch, and right switch with the power and I/O connector as follows:

CONNECTING SWITCHES

Pin	Name	Function
19	REF_R	Right stop switch input for motor 0
21	REF_L	Left stop switch input for motor 0
45	HOME	Input 0 for motor 0
23	REF_R	Right stop switch input for motor 1
25	REF_L	Left stop switch input for motor 1
47	HOME	Input 1 for motor 1
27	REF_R	Right stop switch input for motor 2
29	REF_L	Left stop switch input for motor 2
49	HOME	Input 2 for motor 2

4.3.1.2 TMCM-351

For the reference switch inputs (two reference switch inputs are supported for each motor) there are two connector options: either one detachable screw connector (for prototyping, smaller series) or three separate crimp connectors (for higher volume series).

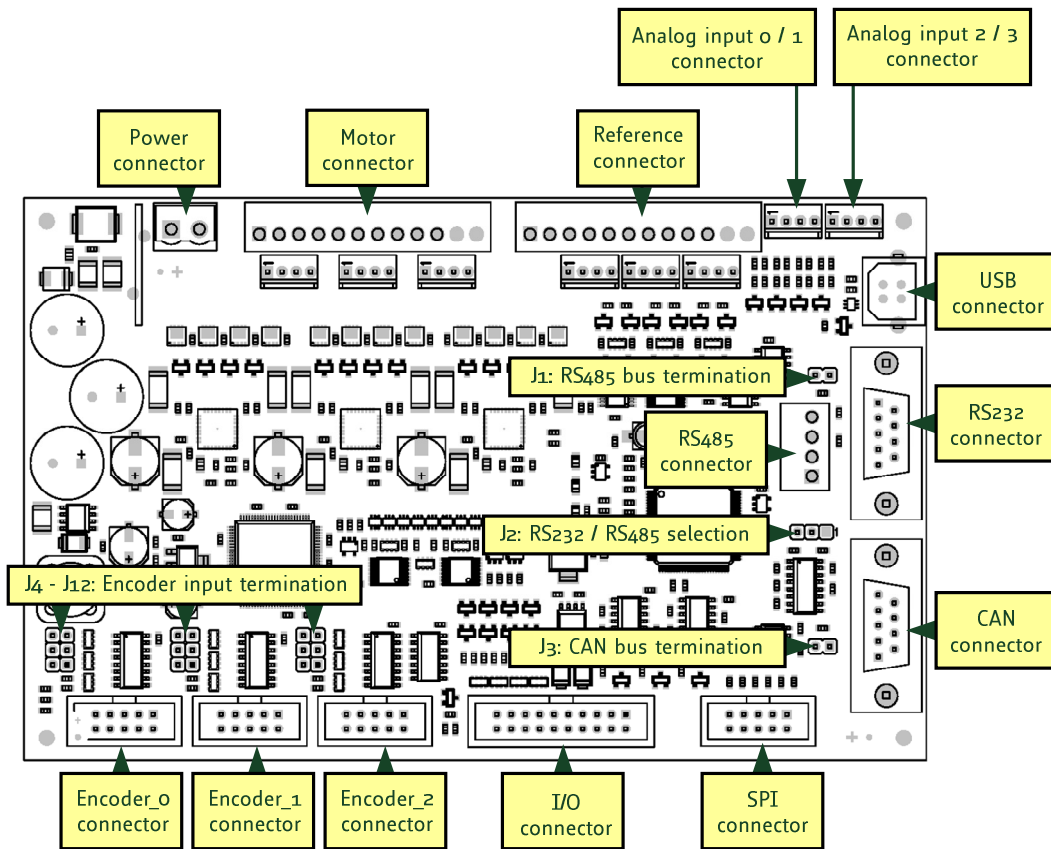

Figure 4.5: Connectors of TMCM-351

Please connect home switch, left switch, and right switch with the reference connector and the I/O connector as follows:

CONNECTING SWITCHES

Pin	Name	Function
1	REF_0_R	Right stop switch input
2	REF_0_L	Left stop switch input
11	HOME_0	Input 0, 24V compatible
5	REF_1_R	Right stop switch input
6	REF_1_L	Left stop switch input
12	HOME_1	Input 1, 24V compatible
9	REF_2_R	Right stop switch input
10	REF_2_L	Left stop switch input
13	HOME_2	Input 2, 24V compatible

4.3.2 Connecting a brake

The modules provide the opportunity to connect a brake for each motor.

4.3.2.1 TMCM-341/342/343

Please connect the brakes with the power and I/O connector as follows:

CONNECTING BRAKES

Pin	Name	Function
46	OUT_0	Connector for brake of motor 0
48	OUT_1	Connector for brake of motor 1
50	OUT_2	Connector for brake of motor 2

4.3.2.2 TMCM-351

Please connect the brakes with the I/O connector of the module as follows:

CONNECTING BRAKES

Pin	Name	Function
1	OUT_0	Connector for brake of motor 0
2	OUT_1	Connector for brake of motor 1
3	OUT_2	Connector for brake of motor 2

4.3.3 Homing Methods

There are several different methods of homing. For choosing your homing method, refer to objects 6098_h/6898_h/7098_h (4.3.4.5).

OVERVIEW: HOMING METHODS

Method no.	Description
0	No homing. This is the default setting.
1	Search the left end switch, than search the next encoder index pulse.
2	Search the right end switch, than search the next encoder index pulse.
3	Search the positive edge of the home switch, than search the next encoder index pulse.
5	Search the negative edge of the home switch, than search the next encoder index pulse.
17	Search the left end switch.
18	Search the right end switch.
19	Search the positive edge of the home switch.
21	Search the negative edge of the home switch.
33	Search next index pulse in negative direction.
34	Search next index pulse in positive direction.
35	The actual position is used as home position. All position values (objects 6062 _h /6862 _h /7062 _h , 6063 _h /6863 _h /7063 _h , and 6064 _h /6864 _h /7064 _h) are set to zero, but the motor will not move.

METHOD 1: HOMING ON NEGATIVE LIMIT SWITCH AND INDEX PULSE

Using this method, the initial direction of movement shall be leftward if the negative limit switch is inactive (here: low). The home position shall be at the first index pulse to the right of the position where the negative limit switch becomes inactive.

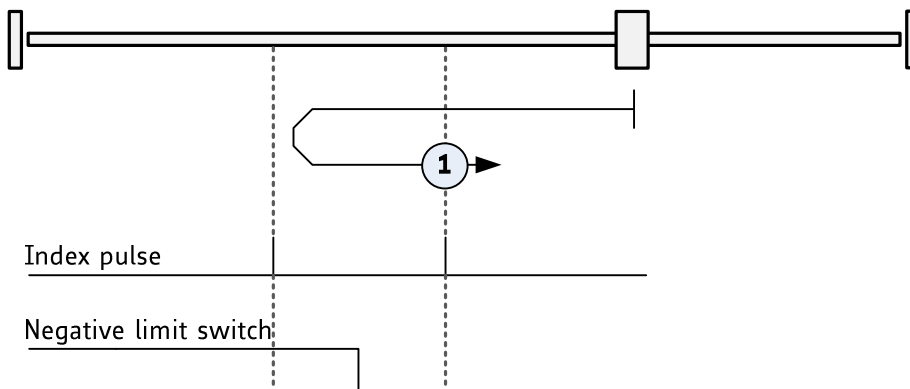

Figure 4.6 Homing on negative switch and index pulse

METHOD 2: HOMING ON POSITIVE LIMIT SWITCH AND INDEX PULSE

Using this method, the initial direction of movement shall be rightward if the positive limit switch is inactive (here: low). The position of home shall be at the first index pulse to the left of the position where the positive limit switch becomes inactive.

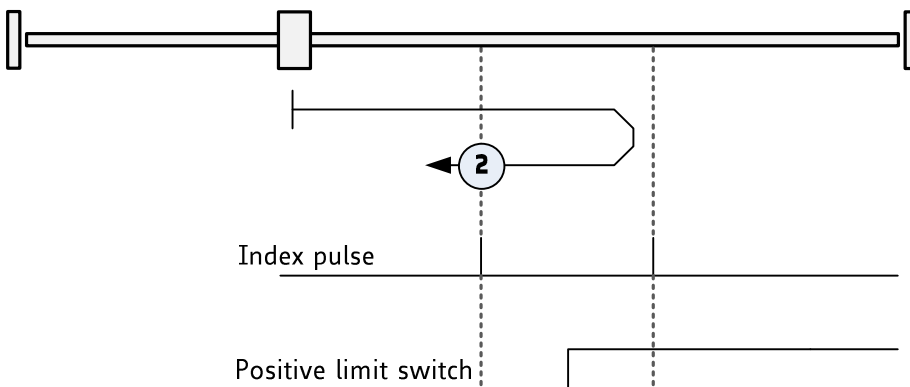

Figure 4.7 Homing on positive limit switch and index pulse

METHOD 3: HOMING ON POSITIVE HOME SWITCH AND INDEX PULSE

Using this method, the initial direction of movement shall be dependent on the state of the home switch. The home position shall be at the index pulse to either to the left or the right of the point where the home switch changes state. If the initial position is situated so that the direction of movement shall reverse during homing, the point at which the reversal takes place is anywhere after a change of state of the home switch.

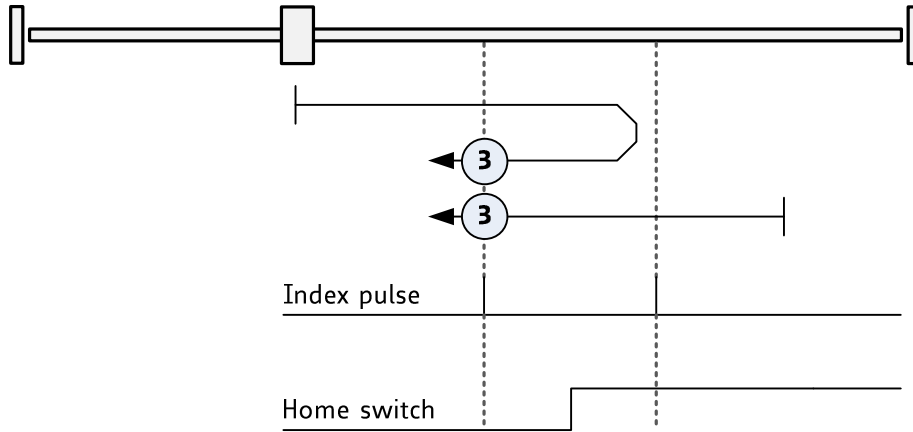

Figure 4.8 Homing on positive home switch and index pulse

METHOD 5: HOMING ON NEGATIVE HOME SWITCH AND INDEX PULSE

Using this method, the initial direction of movement shall be dependent on the state of the home switch. The home position shall be at the index pulse to either to the left or the right of the point where the home switch changes state. If the initial position is situated so that the direction of movement shall reverse during homing, the point at which the reversal takes place is anywhere after a change of state of the home switch.

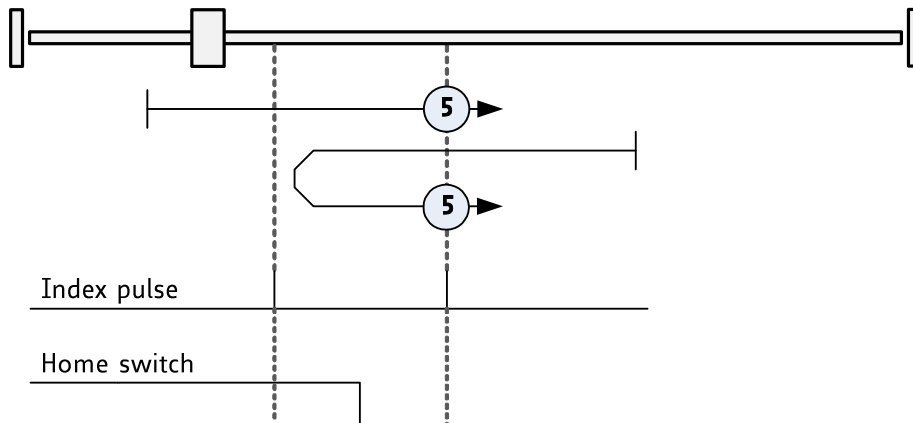

Figure 4.9 Homing on negative home switch and index pulse

METHOD 17, 18, 19, AND 21: HOMING WITHOUT INDEX PULSE

These methods are similar to methods 1 to 5 except that the home position is not dependent on the index pulse but only dependent on the relevant home or limit switch transitions. Method 19 (similar to method 3) is shown in Figure 4.10.

Method no.	Description
17	Search the left end switch. (Similar to method 1)
18	Search the right end switch. (Similar to method 2)
19	Search the positive edge of the home switch. (Similar to method 3)
21	Search the negative edge of the home switch. (Similar to method 5.)

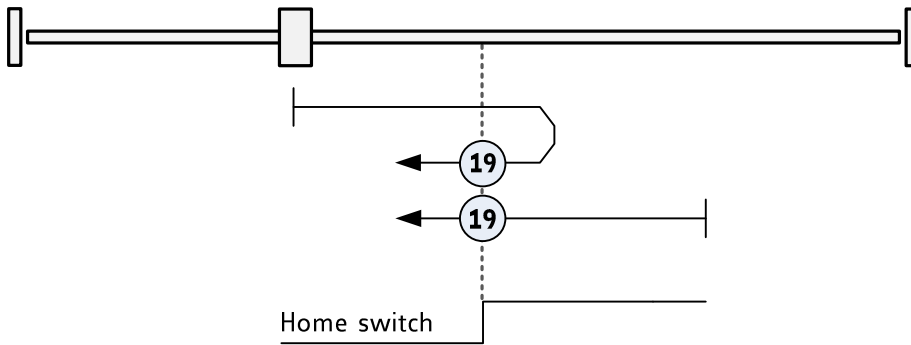

Figure 4.10 Homing without index pulse

METHOD 33 AND 34: HOMING ON NEXT INDEX PULSE

Using these methods, the direction of homing is negative or positive respectively. The home position shall be at the index pulse found in the selected direction as shown in Figure 4.11.

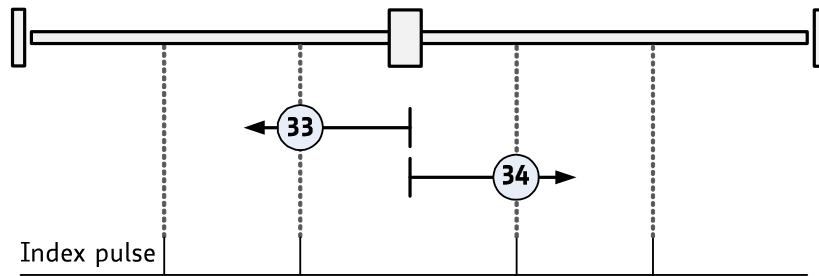

Figure 4.11 Homing on index pulse

METHOD 35: HOMING ON INDEX PULSE / CURRENT POSITION AS HOME POSITION

In this method, the current position shall be taken to be the home position. This method does not require the drive device to be in *operation enabled* state.

4.3.4 Detailed Object Definitions

4.3.4.1 Object 6040_h, 6840_h, and 7040_h: Controlword

These objects indicate the received commands controlling the power drive system finite state automaton (PDS FSA). The CiA-402 state machine can be controlled using the controlword. Please refer to *Figure 4.1 Finite state machine* for detailed information.

STRUCTURE OF CONTROLWORD / VALUE DEFINITION

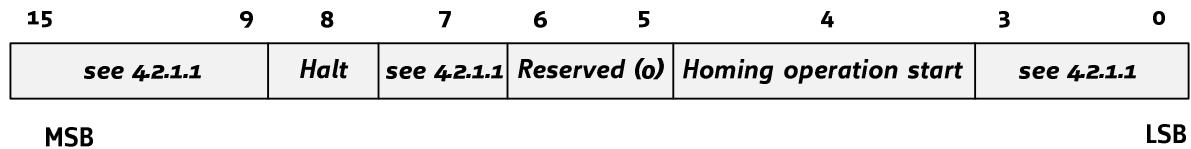

OPERATION MODE SPECIFIC BITS IN HM MODE

Bit	Name	Definition
4	Homing operation start	Set to 1 to start homing; setting to 0 stops homing
8	Halt	Not supported

OBJECT DESCRIPTION

Index	Name	Object Code	Data Type
6040 _h (motor 0)	Controlword	Variable	UNSIGNED16
6840 _h (motor 1)			
7040 _h (motor 2)			

ENTRY DESCRIPTION

Sub-Index	Access	PDO Mapping	Value Range	Default Value
00 _h	rw	Refer to CiA402-3	See command coding above	Device and operation mode specific

4.3.4.2 Object 6041_h, 6841_h, and 7041_h: Statusword

These objects provide the status of the PDS FSA. They reflect the status of the CiA402 state machine for each motor axis. Please refer to *Figure 4.1 Finite state machine* for detailed information. The objects are structured as defined below.

For more information about the coding refer to the *CANopen Drives and motion control device profile, part 2* please.

STRUCTURE OF STATUSWORD / VALUE DEFINITION

15	14	13	12	11	10	9	0
<i>see 4.2.1.2</i>	Homing error	Homing attained	<i>see 4.2.1.2</i>	Target reached	<i>see 4.2.1.2</i>		
MSB				LSB			

OPERATION MODE SPECIFIC BITS IN HM MODE

Bit	Name	Definition
10	Target reached	Set when the zero position has been found or homing has been stopped by setting controlword bit 4 to zero
12	Homing attained	Set when the zero position has been found
13	Homing error	Not supported

DEFINITION OF BIT 10, BIT 12, AND BIT 13

Bit 13	Bit 12	Bit 10	Definition
0	0	0	Homing procedure is in progress
0	0	1	Homing procedure is interrupted or not reached
0	1	0	Homing is attained, but target is not reached
0	1	1	Homing procedure is completed successfully
1	0	0	Homing error occurred, velocity is not 0
1	0	1	Homing error occurred, velocity is 0
1	1	x	reserved

OBJECT DESCRIPTION

Index	Name	Object Code	Data Type
6041 _h (motor 0) 6841 _h (motor 1) 7041 _h (motor 2)	Statusword	Variable	UNSIGNED16

ENTRY DESCRIPTION

Sub-Index	Access	PDO Mapping	Value Range	Default Value
00 _h	ro	Refer to CiA402-3	See state coding above	no

4.3.4.3 Object 606C_h, 686C_h, and 706C_h: Velocity Actual Value

These objects give the actual velocity value for the related motor derived either from a velocity sensor or from a position sensor.

OBJECT DESCRIPTION

Index	Name	Object Code	Data Type
606C _h 686C _h 706C _h	Velocity actual value	Variable	INTEGER32

ENTRY DESCRIPTION

Sub-Index	Access	PDO Mapping	Value Range	Default Value
00 _h	ro	Refer to CiA402-3	INTEGER32	no

4.3.4.4 Object 607C_h, 687C_h, and 707C_h: Home Offset

This object indicates the configured difference between the zero position for the application and the machine home position/home switch (found during homing). While homing, the machine home position is found and once the homing is completed, the zero position is offset from the home position by adding the home offset to the home position. The effect of setting the home position to a non-zero value depends on the selected *homing method*. The value of this object is given in microsteps. Negative values indicate the opposite direction.

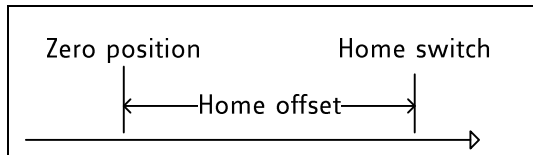

Figure 4.12 Home offset definition

OBJECT DESCRIPTION

Index	Name	Object Code	Data Type
607C _h (motor 0)	Home offset	Variable	SIGNED32
687C _h (motor 1)			
707C _h (motor 2)			

ENTRY DESCRIPTION

Sub-Index	Access	PDO Mapping	Value Range	Default Value
00 _h	rw	Refer to CiA402-3	SIGNED32	-2147483647... +2147483647

4.3.4.5 Object 6098_h, 6898_h, and 7098_h: Homing Method

The homing method to be used in homing mode can be selected here. The actual firmware supports the following homing methods.

VALUE DEFINITION

Value	Definition
0	No homing. This is the default value, but there is actually no homing method 0.
1	Search the left end switch; then search the next encoder index pulse.
2	Search the right end switch; then search the next encoder index pulse.
3	Search the positive edge of the home switch; then search the next encoder index pulse.
5	Search the negative edge of the home switch; then search the next encoder index pulse.
17	Search the left end switch.
18	Search the right end switch.
19	Search the positive edge of the home switch.
21	Search the negative edge of the home switch.
33	Search next index pulse in negative direction.
34	Search next index pulse in positive direction.
35	The actual position is used as home position. All position values (objects 6062 _h /6862 _h /7062 _h , 6063 _h /6863 _h /7063 _h , and 6064 _h /6864 _h /7064 _h) are set to zero, but the motor will not move.

OBJECT DESCRIPTION

Index	Name	Object Code	Data Type
6098 _h (motor 0)	Homing method	Variable	SIGNED8
6898 _h (motor 1)			
7098 _h (motor 2)			

ENTRY DESCRIPTION

Sub-Index	Access	PDO Mapping	Value Range	Default Value
00 _h	rw	Refer to CiA402-3	0, 1, 2, 3, 5, 17, 18, 19, 21, 33, 34, 35	0

4.3.4.6 Object 6099_h, 6899_h, and 7099_h: Homing Speeds

These objects indicate the configured speeds used during homing procedure. The values are given in units, which can be selected with objects 208C_h/228C_h/248C_h, described in paragraph 5.1.18.

Using the *homing speeds* objects, a fast and a slow homing speed can be set. In most homing modes, the home switch is searched with the fast speed first. When the home switch has been found, the motor will be decelerated to the slow speed (using the *homing acceleration*, described in paragraph 4.3.4.7) and then stopped at the exact switch point.

OBJECT DESCRIPTION

Index	Name	Object Code	Data Type
6099 _h (motor 0)	Homing speeds	ARRAY	UNSIGNED32
6899 _h (motor 1)			
7099 _h (motor 2)			

ENTRY DESCRIPTION

Sub-Index	Description	Access	PDO Mapping	Value Range	Default Value
01 _h	Fast homing speed	rw	Refer to CiA402-3	UNSIGNED32	Depends on the unit setting
02 _h	Slow homing speed	rw	Refer to CiA402-3	UNSIGNED32	Depends on the unit setting

4.3.4.7 Object 609A_h, 689A_h, and 709A_h: Homing Acceleration

This object indicates the configured acceleration and deceleration to be used during homing operation. The values for accelerating to the fast homing speed and for decelerating to the slow homing speed can be set here. The values are given in units, which can be selected with object 208E_h/228E_h/248E_h, described in paragraph 0.

OBJECT DESCRIPTION

Index	Name	Object Code	Data Type
609A _h (motor 0)	Homing acceleration	Variable	UNSIGNED32
689A _h (motor 1)			
709A _h (motor 2)			

ENTRY DESCRIPTION

Sub-Index	Access	PDO Mapping	Value Range
00 _h	rw	Refer to CiA402-3	UNSIGNED32

4.3.4.8 Object 2100_h: Home Offset Display

These objects show the configured difference between the zero position for the application and the machine home position/home switch (found during homing). The value is given in microsteps.

OBJECT DESCRIPTION

Index	Name	Object Code	Data Type
2100 _h	Home offset display	Variable	SIGNED32

ENTRY DESCRIPTION

Sub-Index	Access	PDO Mapping	Value Range	Default Value
00 _h	ro	no	Refer to home offset	0

4.3.5 How to start a homing in *hm* mode

Here is a little example that shows how to home the motor in *hm* mode. In this little example we assume that the module has been reset (and then switched to pre-operational or operational) by NMT commands before. The home switch must be connected to the home switch input. It can be operated manually.

- Select *hm* mode by writing 6 to object 6060_h.
- Write 6 to object 6040_h to switch to READY_TO_SWITCH_ON state.
- Write 7 to object 6040_h to switch to SWITCHED_ON state.
- Write 15 to object 6040_h to switch to OPERATION_ENABLED state.
- Select homing method 19 by writing 19 to object 6098_h.
- Set the homing speeds by writing e.g. 1500 to object 6099_h sub index 1 and e.g. 1000 to object 6099_h sub index 2.
- Write 31 to object 6040_h to start the homing process.
- Press and release the home switch.
- When homing has finished, write 15 to object 6040_h again.

4.4 Velocity Mode

The velocity mode is used to control the velocity of the drive without a special regard of the position. It contains limit functions.

THE OPERATION OF THE REFERENCE VALUE GENERATOR AND THE INPUT PARAMETERS INCLUDE:

- Velocity
- Acceleration
- Deceleration
- Emergency stop

Please refer to object 6060_h (section 4.1.6) for information about how to choose an operation mode. Object 6061_h (section 4.1.7) shows the operation mode that is set.

4.4.1 Detailed object definitions

4.4.1.1 Object 6040_h, 6840_h, and 7040_h: Controlword

These objects indicate the received commands controlling the power drive system finite state automaton (PDS FSA). The CiA-402 state machine can be controlled using this object. Please refer to *Figure 4.1* Finite state machine for detailed information.

STRUCTURE OF CONTROLWORD / VALUE DEFINITION

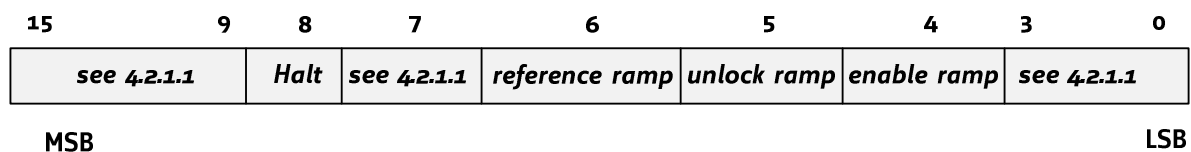

There are no mode specific bits supported in vl mode.

OBJECT DESCRIPTION

Index	Name	Object Code	Data Type
6040 _h (motor 0)	Controlword	Variable	UNSIGNED16
6840 _h (motor 1)			
7040 _h (motor 2)			

ENTRY DESCRIPTION

Sub-Index	Access	PDO Mapping	Value Range	Default Value
00 _h	rw	Refer to CiA402-3	See command coding above	Operation mode specific

4.4.1.2 Object 6041_h, 6841_h, and 7041_h: Statusword

These objects provide the status of the PDS FSA. They reflect the status of the CiA402 state machine for each motor. Please refer to *Figure 4.1 Finite state machine* for detailed information. The objects are structured as defined below.

For more information about the coding refer to the *CANopen Drives and motion control device profile, part 2* please.

STRUCTURE OF STATUSWORD / VALUE DEFINITION

15	14	13	12	11	10	9	0
<i>see 4.2.1.2</i>		<i>reserved (0)</i>		<i>see 4.2.1.2</i>		<i>See 4.2.1.2</i>	
MSB							LSB

There are no mode specific bits supported in vl mode.

OBJECT DESCRIPTION

Index	Name	Object Code	Data Type
6041 _h (motor 0)	Controlword	Variable	UNSIGNED16
6841 _h (motor 1)			
7041 _h (motor 2)			

ENTRY DESCRIPTION

Sub-Index	Access	PDO Mapping	Value Range	Default Value
00 _h	ro	Refer to CiA402-3	See state coding above	No

4.4.1.3 Object 6042_h, 6842_h, and 7042_h: vl Target Velocity

This object indicates the required velocity of the system. It is the target velocity when the velocity mode is active. Use this object to control the velocity of the motor in velocity mode. When this object is changed the motor will be accelerated or decelerated to the new velocity.

The range depends on the chosen units, which can be internal or user-specific. Please refer to object 208C_h/228C_h/248C_h (paragraph 5.1.18) for more information about that.

OBJECT DESCRIPTION

Index	Name	Object Code	Data Type
6042 _h (motor 0)	vl target velocity	Variable	SIGNED16
6842 _h (motor 1)			
7042 _h (motor 2)			

ENTRY DESCRIPTION

Sub-Index	Access	PDO Mapping	Value Range	Default Value
00 _h	rw	Refer to CiA402-3	SIGNED32	Depends on the units.

4.4.1.4 Object 6043_h, 6843_h, and 7043_h: vI Velocity Demand

The object provides the instantaneous velocity generated by the ramp function. It shows the last target velocity that has been set using object 6042_h, 6842_h, and 7042_h.

The value is given in the same unit as the target velocity. Please refer to object 208C_h/228C_h/248C_h (paragraph 5.1.18) for more information about that.

OBJECT DESCRIPTION

Index	Name	Object Code	Data Type
6043 _h (motor 0)	vI velocity demand	Variable	SIGNED16
6843 _h (motor 1)			
7043 _h (motor 2)			

ENTRY DESCRIPTION

Sub-Index	Access	PDO Mapping	Value Range	Default Value
00 _h	ro	Refer to CiA402-3	SIGNED32	0

4.4.1.5 Object 6044_h, 6844_h, and 7044_h: vI Velocity Actual Value

This object shows the actual velocity of the motor when the motor is in velocity mode.

The value is given in the same unit as vI target velocity and vI velocity demand. Please refer to object 208C_h/228C_h/248C_h (paragraph 5.1.18) for more information about that.

OBJECT DESCRIPTION

Index	Name	Object Code	Data Type
6044 _h (motor 0)	vI velocity actual value	Variable	SIGNED16
6844 _h (motor 1)			
7044 _h (motor 2)			

ENTRY DESCRIPTION

Sub-Index	Access	PDO Mapping	Value Range	Default Value
00 _h	ro	Refer to CiA402-3	SIGNED32	0

4.4.1.6 Object 6046_h, 6846_h, and 7046_h: vI Velocity Min Max Amount

These objects indicate the configured minimum and maximum amounts of velocity in velocity mode for all three motors.

OBJECT DESCRIPTION

Index	Name	Object Code	Data Type
6046 _h (motor 0)	vI velocity min max amount	ARRAY	UNSIGNED32
6846 _h (motor 1)			
7046 _h (motor 2)			

ENTRY DESCRIPTION

Sub-Index	Description	Access	PDO Mapping	Value Range	Default Value
00 _h	Highest sub-index supported	c	Refer to CiA402-3	02 _h	2
01 _h	Minimum velocity amount	rw/ro	Refer to CiA402-3	UNSIGNED32	0
02 _h	Maximum velocity amount	rw/ro	Refer to CiA402-3	UNSIGNED32	2047

4.4.1.7 Object 6048_n, 6848_n, and 7048_n: vI Velocity Acceleration

These objects indicate the configured delta speed and delta time of the slope of the acceleration ramp for each motor. The objects provide the accelerations used in velocity mode. These values are also used for the deceleration. The values of the delta speed are given in internal or in user units (rpm/s).

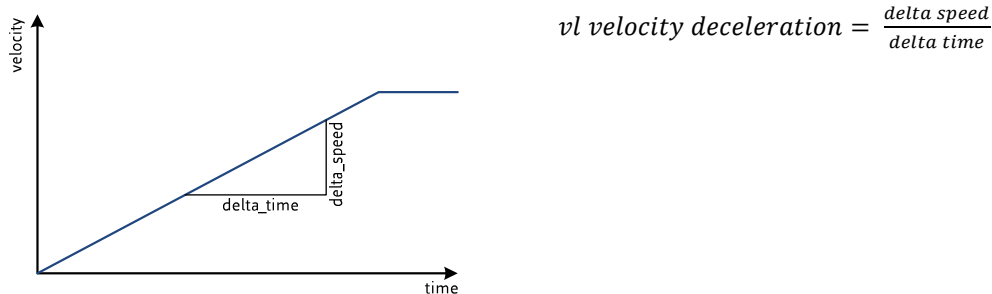

Figure 4.13 Transfer characteristic of the velocity acceleration

OBJECT DESCRIPTION

Index	Name	Object Code	Data Type
6048 _n (motor 0) 6848 _n (motor 1) 7048 _n (motor 2)	vI velocity acceleration	Record	vI acceleration deceleration

ENTRY DESCRIPTION

Sub-Index	Description	Access	PDO Mapping	Value Range	Default Value
00 _h	Highest sub-index supported	c	Refer to CiA402-3	02 _h	2
01 _h	Delta speed	rw	Refer to CiA402-3	UNSIGNED32	1000
02 _h	Delta time	ro	Refer to CiA402-3	UNSIGNED16	1msec

4.4.1.8 Object 6049_n, 6849_n, and 7049_n: vI Velocity Deceleration

These objects contain the same values as set in the objects 6048_n, 6848_n, and 7048_n. A separate deceleration value is not supported. The deceleration is according to the acceleration.

OBJECT DESCRIPTION

Index	Name	Object Code	Data Type
6049 _n (motor 0) 6849 _n (motor 1) 7049 _n (motor 2)	vI velocity deceleration	Record	vI acceleration deceleration

ENTRY DESCRIPTION

Sub-Index	Description	Access	PDO Mapping	Value Range	Default Value
00 _h	Highest sub-index supported	c	Refer to CiA402-3	02 _h	2
01 _h	Delta speed	ro	Refer to CiA402-3	UNSIGNED32	1000
02 _h	Delta time	ro	Refer to CiA402-3	UNSIGNED16	1msec

4.4.2 How to Move a Motor in vI Mode

Here is a little example that shows how to get a motor running in vI mode. In this little example we assume that the module has been reset (and then switched to pre-operational or operationla) by NMT commands before.

- If you do not have any limit switches connected, first disable the limit switch inputs by writing 3 to object 2005_h.
- Select vI mode by writing 2 to object 6060_h.
- Write 6 to object 6040_h to switch to READY_TO_SWITCH_ON state.
- Write 7 to object 6040_h to switch to SWITCHED_ON state.
- Write 15 to object 6040_h to switch to OPERATION_ENABLED state.
- Write the desired target speed (e.g. 500) to object 6042_h. The motor now accelerates to that speed.
- Stop the motor by writing 0 to object 6042_h.

4.5 Profile Velocity Mode

The profile velocity mode is used to control the velocity of the drive without a special regard of the position. It contains limit functions and trajectory generation.

THE PROFILE VELOCITY MODE COVERS THE FOLLOWING SUB-FUNCTIONS:

- Demand value input via trajectory generator
- Monitoring of the profile velocity using a window-function
- Monitoring of velocity actual value using a threshold

THE OPERATION OF THE REFERENCE VALUE GENERATOR AND ITS INPUT PARAMETERS INCLUDE:

- Profile velocity
- Profile acceleration
- Profile deceleration
- Emergency stop
- Motion profile type
- Detailed object definitions

4.5.1.1 Object 6040_h, 6840_h, and 7040_h: Controlword

These objects indicate the received commands controlling the power drive system finite state automaton (PDS FSA). The CiA-402 state machine can be controlled using these objects. Please refer to Figure 4.1 for detailed information.

STRUCTURE OF CONTROLWORD / VALUE DEFINITION

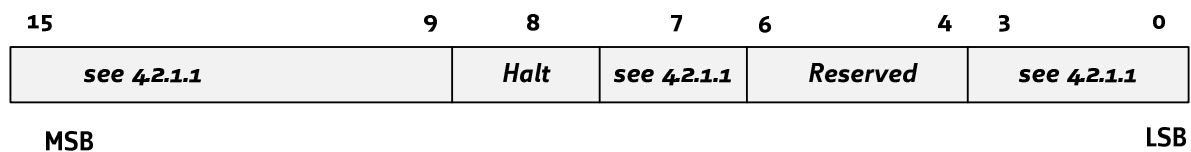

There are no mode specific bits supported in this mode.

OBJECT DESCRIPTION

Index	Name	Object Code	Data Type
6040 _h (motor 0)	Controlword	Variable	UNSIGNED16
6840 _h (motor 1)			
7040 _h (motor 2)			

ENTRY DESCRIPTION

Sub-Index	Access	PDO Mapping	Value Range	Default Value
00 _h	rw	Refer to CiA402-3	See command coding above	Device and operation mode specific

4.5.1.2 Object 6041_h, 6841_h, and 7041_h: Statusword

These objects provide the status of the PDS FSA. They reflect the status of the CiA402 state machine for each motor. Please refer to *Figure 4.1 Finite state machine* for detailed information. The objects are structured as defined below.

For more information about the coding refer to the *CANopen drives and motion control device profile, part 2* please.

STRUCTURE OF STATUSWORD / VALUE DEFINITION

15	14	13	12	11	10	9	0
<i>see 4.2.1.2</i>	<i>Max slippage error</i>	<i>Speed</i>	<i>see 4.2.1.2</i>	<i>Target reached</i>	<i>see 4.2.1.2</i>		
MSB						LSB	

OPERATION MODE SPECIFIC BITS IN PV MODE

Bit	Name	Definition
10	Target reached	Indicates that the desired speed is reached
12	Speed	Not supported
13	Max slippage error	Not supported

OBJECT DESCRIPTION

Index	Name	Object Code	Data Type
6041 _h (motor 0)	Controlword	Variable	UNSIGNED16
6841 _h (motor 1)			
7041 _h (motor 2)			

ENTRY DESCRIPTION

Sub-Index	Access	PDO Mapping	Value Range	Default Value
00 _h	ro	Refer to CiA402-3	See state coding above	no

4.5.1.3 Object 6062_h, 6862_h, and 7062_h: Position Demand Value

These objects provide the demanded position values. The values are given in microsteps. The *position demand value* objects indicate the actual positions that the motors should have. These objects are not to be confused with the *position actual internal value* (paragraph 4.5.1.4) and the *position actual value* (paragraph 4.5.1.5).

OBJECT DESCRIPTION

Index	Name	Object Code	Data Type
6062 _h (motor 0)	Position demand value	Variable	SIGNED32
6862 _h (motor 1)			
7062 _h (motor 2)			

ENTRY DESCRIPTION

Sub-Index	Access	PDO Mapping	Value Range	Default Value
00 _h	ro	Refer to CiA402-3	SIGNED32	no

4.5.1.4 Object 6063_h, 6863_h, and 7063_h: Position Actual Internal Value

These objects indicate the actual position of the encoder of each motor, re-scaled to the microstep resolution. If necessary, the data unit may be transformed from user-defined units to increments. The value is given in microsteps or encoder steps, depending on objects 606A_h, 686A_h, and 706A_h (4.1.8).

OBJECT DESCRIPTION

Index	Name	Object Code	Data Type
6063 _h (motor 0) 6863 _h (motor 1) 7063 _h (motor 2)	Position actual internal value	Variable	SIGNED32

ENTRY DESCRIPTION

Sub-Index	Access	PDO Mapping	Value Range	Default Value
00 _h	ro	Refer to CiA402-3	SIGNED32	no

4.5.1.5 Object 6064_h, 6864_h, and 7064_h: Position Actual Value

These objects provide the actual values of the position measurement devices. They always contain the same values as objects 6063_h, 6863_h, and 7063_h. The values are given in microsteps.

OBJECT DESCRIPTION

Index	Name	Object Code	Data Type
6064 _h (motor 0) 6864 _h (motor 1) 7064 _h (motor 2)	Position actual value	Variable	SIGNED32

ENTRY DESCRIPTION

Sub-Index	Access	PDO Mapping	Value Range	Default Value
00 _h	ro	Refer to CiA402-3	SIGNED32	no

4.5.1.6 Object 6065_h, 6865_h, and 7065_h: Following Error Window

These objects indicate the configured ranges of tolerated position values symmetrically to the position demand values. If a position actual value is out of the following error window, a following error occurs. A following error may occur when a drive is blocked, unreachable profile velocity occurs, or at wrong closed-loop coefficients. The values are given in microsteps. If the value of the following error window is 0 or FFFF FFFF_h, the following control will be switched off.

If the difference between motor position (objects 6062_h, 6862_h, and 7062_h) and encoder position (objects 6063_h, 6863_h, and 7063_h or 6064_h, 6864_h, and 7064_h) is greater than the value set here, the related motors will be stopped and emergency messages will be sent.

Setting these objects to zero will turn off this feature completely. Setting these objects to a too low value will lead to false alarms.

OBJECT DESCRIPTION

Index	Name	Object Code	Data Type
6065 _h (motor 0) 6865 _h (motor 1) 7065 _h (motor 2)	Following error window	Variable	UNSIGNED32

ENTRY DESCRIPTION

Sub-Index	Access	PDO Mapping	Value Range	Default Value
00 _h	rw	Refer to CiA402-3	UNSIGNED32	0... 8388607

4.5.1.7 Object 606C_h, 686C_h, and 706C_h: Velocity Actual Value

These objects give the actual velocity values derived either from the velocity sensors or from the position sensors of the related motors.

OBJECT DESCRIPTION

Index	Name	Object Code	Data Type
606C _h (motor 0) 686C _h (motor 1) 706C _h (motor 2)	Velocity actual value	Variable	INTEGER32

ENTRY DESCRIPTION

Sub-Index	Access	PDO Mapping	Value Range	Default Value
00 _h	ro	Refer to CiA402-3	INTEGER32	no

4.5.1.8 Object 607D_h, 687D_h, and 707D_h: Software Position Limit

These objects indicate the configured maximum and minimum software position limits for each axis. These parameters define the absolute position limits for the *position demand value* (4.5.1.3) and the *position actual value* (4.5.1.5). The *position actual value* is always checked against these limits. The limit position is always relative to the machine home position. Before being compared with the specific target position, they have to be corrected internally by the home offset as follows:

$$\begin{aligned} \text{Corrected min position limit} &= \text{min position limit} - \text{home offset} \\ \text{Corrected max position limit} &= \text{max position limit} - \text{home offset} \end{aligned}$$

This calculation needs only be performed when home offset or software position limit is changed.

The limit positions are given in microsteps (same as *target position*). Two limits for each motor for moving them in positioning mode can be set here. Overstepping the window will lead to an emergency message and the specific motor will be stopped.

OBJECT DESCRIPTION

Index	Name	Object Code	Data Type
607D _h (motor 0) 687D _h (motor 1) 707D _h (motor 2)	Software position limit	Array	SIGNED32

ENTRY DESCRIPTION

Sub-Index	Description	Access	PDO Mapping	Value Range	Default Value
01 _h	Min position limit	rw	Refer to CiA402-3	SIGNED32	-2147483647... +2147483647
02 _h	Max position limit	rw	Refer to CiA402-3	SIGNED32	-2147483647... +2147483647

4.5.1.9 Object 6083_h, 6883_h, and 7083_h: Profile Acceleration

These objects indicate the configured acceleration. The three *profile acceleration* objects set the maximum acceleration for each axis to be used in profile velocity mode.

Please choose the units for these objects with objects 208E_h/228E_h/248E_h, described in paragraph 0. The objects 208E_h/228E_h/248E_h read 0 when internal units are selected or 179 when user units (PPS/s) are selected.

OBJECT DESCRIPTION

Index	Name	Object Code	Data Type
6083 _h (motor 0) 6883 _h (motor 1) 7083 _h (motor 2)	Profile acceleration	Variable	UNSIGNED32

ENTRY DESCRIPTION

Sub-Index	Access	PDO Mapping	Value Range	Default Value
00 _h	rw	Refer to CiA402-3	UNSIGNED32	Depends on the units

4.5.1.10 Object 6084_h, 6884_h, and 7084_h: Profile Deceleration

These objects indicate the configured deceleration. They set the maximum deceleration for each axis used in profile velocity mode.

Please choose the units for these objects with objects 208E_h/228E_h/248E_h, described in paragraph 5.1.19. The objects 208E_h/228E_h/248E_h read 0 when internal units are selected or 179 when user units (PPS/s) are selected. The deceleration is according to the acceleration.

OBJECT DESCRIPTION

Index	Name	Object Code	Data Type
6084 _h (motor 0)	Profile deceleration	Variable	UNSIGNED32
6884 _h (motor 1)			
7084 _h (motor 2)			

ENTRY DESCRIPTION

Sub-Index	Access	PDO Mapping	Value Range	Default Value
00 _h	rw	Refer to CiA402-3	UNSIGNED32	Depends on the units

4.5.1.11 Object 60FF_h, 62FF_h, and 64FF_h: Target Velocity

The target velocity objects set the target velocity for the related motors when using profile velocity mode. They are used as input for the trajectory generator. The drive then accelerates or decelerates to that velocity using the acceleration and deceleration set by objects 6083_h/6883_h/7083_h (4.2.1.14) and 6084_h/6884_h/7084_h (4.2.1.15). The values are given in units, which can be selected with objects 208C_h/228C_h/248C_h, described in paragraph 5.1.18.

OBJECT DESCRIPTION

Index	Name	Object Code	Data Type
60FF _h	Target velocity	Variable	SIGNED32
68FF _h			
70FF _h			

ENTRY DESCRIPTION

Sub-Index	Access	PDO Mapping	Value Range	Default Value
00 _h	rw	Refer to CiA402-3	SIGNED32	-2147483647... +2147483647 / depends on selected units

4.5.2 How to Move a Motor in *pv* Mode

Here is a little example that shows how to get a motor running in *pv* mode. In this little example we assume that the module has been reset (and then switched to pre-operational or operational) by NMT commands before.

- If you do not have any limit switches connected, first disable the limit switch inputs by writing 3 to object 2005_h.
- Select *pv* mode by writing 3 to object 6060_h.
- Write 6 to object 6040_h to switch to READY_TO_SWITCH_ON state.
- Write 7 to object 6040_h to switch to SWITCHED_ON state.
- Write 15 to object 6040_h to switch to OPERATION_ENABLED state.
- Write the desired target speed (e.g. 1500) to object 60FF_h. The motor now accelerates to that speed.
- Stop the motor by writing 0 to object 60FF_h.

5 Manufacturer Specific Area

The manufacturer segment contains manufacturer specific objects. These objects control the special features of the TRINAMIC motion control devices TMC320-341/342/343 and TMC320-351.

5.1 Detailed Object Specifications

5.1.1 Object 2000_h, 2200_h, and 2400_h: Microstep Resolution

These objects set the microstep resolution for each axis. A value of 6 means 64 microsteps (2⁶). They are only writeable in the SWITCHED_ON_DISABLED state, but always readable.

VALUE DESCRIPTION

Value	Description
0	1 step
1	2 microsteps
2	4 microsteps
3	8 microsteps
4	16 microsteps
5	32 microsteps
6	64 microsteps

OBJECT DESCRIPTION

Index	Name	Object Code	Data Type
2000 _h (motor 0)	Microstep resolution	Variable	UNSIGNED8
2200 _h (motor 1)			
2400 _h (motor 2)			

ENTRY DESCRIPTION

Sub-Index	Access	PDO Mapping	Value Range	Default Value
00 _h	rw	no	0.. 8	6

5.1.2 Object 2001_h, 2201_h, and 2401_h: Fullstep Resolution

These objects show the fullstep resolutions of each axis.

OBJECT DESCRIPTION

Index	Name	Object Code	Data Type
2001 _h (motor 0)	Fullstep resolution	Variable	UNSIGNED16
2201 _h (motor 1)			
2401 _h (motor 2)			

ENTRY DESCRIPTION

Sub-Index	Access	PDO Mapping	Value Range	Default Value
00 _h	ro	no	200	200

5.1.3 Object 2002_h, 2202_h, and 2402_h: Brake Delay Times

With this object the delay times for applying and releasing an (optional) brake can be defined. Please see also object 200A_h, 220A_h, and 240A_h for an additional delay between enabling the power stage and releasing the brake. Both times are given in ms.

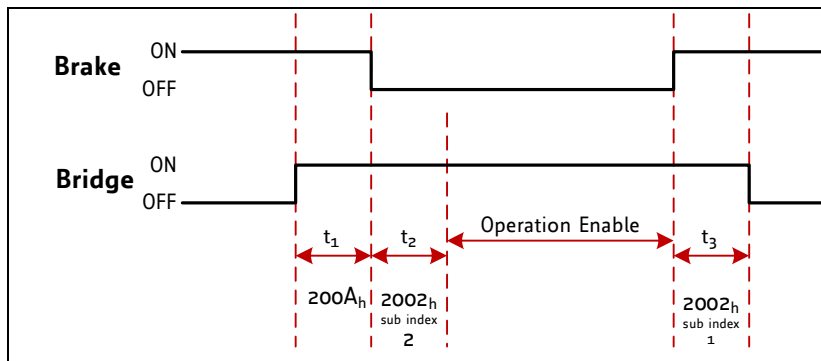

Figure 5.1 Brake output timing

OBJECT DESCRIPTION

Index	Name	Object Code	Data Type
2002 _h (motor 0)	Brake delay times	ARRAY	UNSIGNED16
2202 _h (motor 1)			
2402 _h (motor 2)			

ENTRY DESCRIPTION

Sub-Index	Description	Access	PDO Mapping	Value Range	Default Value
01 _h	Time between applying brake / disabling power stage	rw	no	0... 65535	0
02 _h	Time between releasing brake / switching the state machine to operational	rw	no	0... 65535	0

5.1.4 Object 2003_h, 2203_h, and 2403_h: Maximum Current

These objects define the currents used when the motors are moving. A value of 255 means 100% of the maximum current of a drive.

OBJECT DESCRIPTION

Index	Name	Object Code	Data Type
2003 _h (motor 0)	Maximum current	Variable	UNSIGNED8
2203 _h (motor 1)			
2403 _h (motor 2)			

ENTRY DESCRIPTION

Sub-Index	Access	PDO Mapping	Value Range	Default Value
00 _h	rw	no	0... 255	228

5.1.5 Object 2004_h, 2204_h, and 2404_h: Standby Current

This object defines the current used when the motor is standing (two seconds after the last move). A value of 255 means 100% of the maximum current of the drive.

OBJECT DESCRIPTION

Index	Name	Object Code	Data Type
2004 _h (motor 0)	Standby current	Variable	UNSIGNED8
2204 _h (motor 1)			
2404 _h (motor 2)			

ENTRY DESCRIPTION

Sub-Index	Access	PDO Mapping	Value Range	Default Value
00 _h	rw	no	0... 255	20

5.1.6 Object 2005_h, 2205_h, and 2405_h: Limit Switches

These objects define which limit switches are to be used for related specific motor axes. Bit 0 stands for the left and bit 1 stands for the right limit switch. If a bit is set, the corresponding limit switch will not be used. So, this object has to be set to the value 3 if limit switches are not connected. The objects can only be written when the drive is in the SWITCHED_ON_DISABLED state (but is always readable).

The limit switches can also be inverted using bit 2 and bit 3:

- Bit 2 inverts the left limit switch
- Bit 3 inverts the right limit switch

OBJECT DESCRIPTION

Index	Name	Object Code	Data Type
2005 _h (motor 0)	Limit switches	Variable	UNSIGNED32
2205 _h (motor 1)			
2405 _h (motor 2)			

ENTRY DESCRIPTION

Sub-Index	Access	PDO Mapping	Value Range	Default Value
00 _h	rw	no	0... 7	0

Bit	Definition
0	Left limit switch deactivated, if set.
1	Right limit switch deactivated, if set.
2	Left limit switch inverted, if set.
3	Right limit switch inverted, if set.
4	Home switch deactivated, if set.
5	Home switch inverted, if set.

5.1.7 Object 2006_h, 2206_h, and 2406_h: Mixed Decay Threshold

This object defines the behavior of the mixed decay feature of the drive. When it is set to the value -1, fast decay is always used. When it is set to a value between 0... 2047, fast decay will only be used when the internal velocity is higher or equal to that value. When set to 2048, fast decay will never be used.

It is recommended to use -1. Set this value to 2048 if stallGuard is used.

OBJECT DESCRIPTION

Index	Name	Object Code	Data Type
2006 _h (motor 0)	Mixed decay threshold	Variable	UNSIGNED32
2206 _h (motor 1)			
2406 _h (motor 2)			

ENTRY DESCRIPTION

Sub-Index	Access	PDO Mapping	Value Range	Default Value
00 _h	rw	no	-1... 2048	-1

5.1.8 Object 2007_h, 2207_h, and 2407_h: Stall Detection Threshold

This object defines if stallGuard is to be used. When set to 0, stallGuard is not used. If set to 1... 7 the motor will be stopped and an emergency message will be generated if the stall guard value is the same or higher than the value set here. Switch off mixed decay (2006_h) before using stallGuard.

OBJECT DESCRIPTION

Index	Name	Object Code	Data Type
2007 _h (motor 0)	Stall detection threshold	Variable	UNSIGNED8
2207 _h (motor 1)			
2407 _h (motor 2)			

ENTRY DESCRIPTION

Sub-Index	Access	PDO Mapping	Value Range	Default Value
00 _h	rw	no	0... 7	0

5.1.9 Object 2009_h, 2209_h, and 2409_h: Fullstep Threshold

If the internal velocity gets higher than the value defined here the motor is switched to fullstep operation. A value of 0 or 2048 turns off this feature. Normally only needed for getting more force in higher speeds.

OBJECT DESCRIPTION

Index	Name	Object Code	Data Type
2009 _h (motor 0)	Fullstep threshold	Variable	UNSIGNED8
2209 _h (motor 1)			
2409 _h (motor 2)			

ENTRY DESCRIPTION

Sub-Index	Access	PDO Mapping	Value Range	Default Value
00 _h	ro	no	0... 2048	0

5.1.10 Object 200A_h, 220A_h, and 240A_h: Enable Drive Delay Time

This is an additional delay time (in milliseconds) between enabling the power stage and releasing the brake. It can be used to prevent the brake from being released too early (before the hold current in the motor has been reached). Please see also object 2002_h.

OBJECT DESCRIPTION

Index	Name	Object Code	Data Type
200A _h (motor 0)	Enable drive delay time	Variable	UNSIGNED16
220A _h (motor 1)			
240A _h (motor 2)			

ENTRY DESCRIPTION

Sub-Index	Access	PDO Mapping	Value Range	Default Value
00 _h	rw	no	0... 65535	0

5.1.11 Object 200B_h, 220B_h, and 240B_h: Encoder parameters

These objects define the polarity of the encoder null channel. They are only writable in SWITCHED_ON_DISABLED state. With the TMCM-351, TMCM-341, TMCM-342, and TMCM-343 only sub-index 03_h can be used.

OBJECT DESCRIPTION

Index	Name	Object Code	Data Type
200B _h (motor 0)	Encoder parameters	ARRAY	UNSIGNED8
220B _h (motor 1)			
240B _h (motor 2)			

ENTRY DESCRIPTION

Sub-Index	Description	Access	PDO Mapping	Value Range	Default Value
01 _h	Null channel polarity	rw	no	UNSIGNED8	7

This object defines the polarity of the encoder null channel. The following options can be selected:

Bit 0: polarity of channel A on index pulse (0=low, 1=high).

Bit 1: polarity of channel B on index pulse (0=low, 1=high).

Bit 2: polarity of channel N on index pulse (0=low, 1=high).

Bit 3: ignore channel A/B polarity on index pulse.

This object is only writable in SWITCHED_ON_DISABLED state.

5.1.12 Object 200Ch, 220Ch, and 240Ch: Brake Current Feed

This object configures how much current has to be fed into the brake to apply and to release it. 0 means 0%, 255 means 100% of the maximum current (this depends on the module). In most cases it is needed to feed current into the brake to release it. The default configuration is made for this case.

Setting both values to 0 disables the automatic brake control. This object is only writable in SWITCHED_ON_DISABLED state.

Please note that on the three axis modules only 0 (brake output switched off) and 255 (brake output switched on) can be used. Set both values to zero if no brake is used. In such a case the brake output can be used as a normal digital output.

OBJECT DESCRIPTION

Index	Name	Object Code	Data Type
200Ch (motor 0)	Brake current feed	ARRAY	UNSIGNED8
220Ch (motor 1)			
240Ch (motor 2)			

ENTRY DESCRIPTION

Sub-Index	Description	Access	PDO Mapping	Value Range	Default Value
01h	Apply current	rw	no	UNSIGNED8	0
02h	Release current	rw	no	UNSIGNED8	255

5.1.13 Object 204Eh, 224Eh, and 244Eh: Boost Current

These objects are used to set the current used for acceleration and deceleration phases for each motor. If set to 0 the current set with objects 2003h, 2203h, and 2403h (5.1.4) will be used. The value 1 can be chosen for a minimum boost current setting. A value of 255 means 100% of the maximum possible current of the module.

OBJECT DESCRIPTION

Index	Name	Object Code	Data Type
204Eh (motor 0)	Boost current	Variable	UNSIGNED8
224Eh (motor 1)			
244Eh (motor 2)			

ENTRY DESCRIPTION

Sub-Index	Access	PDO Mapping	Value Range	Default Value
00h	rw	no	0... 255	0

5.1.14 Object 2085h, 2285h, and 2485h: Ramp Divisor

Use these objects to define the ramp divisor for each axis when internal units are selected for velocity and acceleration. These objects can only be written in the SWITCHED_ON_DISABLE state (but is always readable). The exponent of the scaling factor for a ramp generator- should be de/incremented carefully (in steps of one).

OBJECT DESCRIPTION

Index	Name	Object Code	Data Type
2085h (motor 0)	Ramp divisor	Variable	UNSIGNED8
2285h (motor 1)			
2485h (motor 2)			

ENTRY DESCRIPTION

Sub-Index	Access	PDO Mapping	Value Range	Default Value
00h	rw <i>not writable if user units are selected</i>	no	0... 13	7

5.1.15 Object 2086_h, 2286_h, and 2486_h: Pulse Divisor

Use these objects to define the pulse divisor for each axis when internal units are to be used for velocity and acceleration. These objects can only be written in the SWITCHED_ON_DISABLED state (but is always readable). The exponent of the scaling factor for a pulse (step) generator – should be de/incremented carefully (in steps of one).

OBJECT DESCRIPTION

Index	Name	Object Code	Data Type
2086 _h (motor 0) 2286 _h (motor 1) 2486 _h (motor 2)	Pulse divisor	Variable	UNSIGNED8

ENTRY DESCRIPTION

Sub-Index	Access	PDO Mapping	Value Range	Default Value
00 _h	rw <i>not writable if user units are selected</i>	no	0.. 13	3

5.1.16 Object 2087_h, 2287_h, and 2487_h: Maximum Velocity

The functionality of these objects depends on the unit selection for each axis (refer to objects 208C_h/228C_h/248C_h in chapter 5.1.18):

- If internal units are selected these objects will be set to the fixed value of 2047 and cannot be changed.
- If user units are selected the maximum velocity (RPM or PPS) that is to be used must be set here. A lower value in this object leads to a better accuracy of the unit conversion.

This value can only be changed when the drive is in the SWITCHED_ON_DISABLED state.

OBJECT DESCRIPTION

Index	Name	Object Code	Data Type
2087 _h (motor 0) 2287 _h (motor 1) 2487 _h (motor 2)	Maximum velocity	Variable	UNSIGNED32

ENTRY DESCRIPTION

Sub-Index	Access	PDO Mapping	Value Range	Default Value
00 _h	rw	no	143... 293 (rpm) 499755 (pps) resp. 2047 (internal)	2047

5.1.17 Object 2088_h, 2288_h, and 2488_h: Maximum Acceleration

The functionality of these objects also depends on the unit selection (refer to objects 208E_h/228E_h/248E_h in chapter 5.1.19):

- If internal units are selected this object will be set to the fixed value of 2047 and cannot be changed.
- If user units are selected the maximum acceleration (RPM/s or PPS/s) that is to be used must be set here. A lower value in this object leads to a better accuracy of the unit conversion.

This value can only be change when the drive is in the SWITCHED_ON_DISABLED state.

OBJECT DESCRIPTION

Index	Name	Object Code	Data Type
2088 _h (motor 0)	Maximum acceleration	Variable	UNSIGNED32
2288 _h (motor 1)			
2488 _h (motor 2)			

ENTRY DESCRIPTION

Sub-Index	Access	PDO Mapping	Value Range	Default Value
00 _h	rw	no	2183.. 4000 (rpm/s) 976085662 (pps/s) resp. 2047 (internal)	2047

5.1.18 Object 208C_h, 228C_h, and 248C_h: Velocity Dimension Index

With these objects different units can be chosen:

- Writing 0 selects internal units for velocity and acceleration.
- Writing 164 sets RPM for velocity and RPM/s for acceleration.
- Writing 181 sets PPS for velocity and PPS/s for acceleration.

This can only be changed in SWITCHED_ON_DISABLED mode.

OBJECT DESCRIPTION

Index	Name	Object Code	Data Type
208C _h (motor 0)	Velocity dimension index	Variable	UNSIGNED8
228C _h (motor 1)			
248C _h (motor 2)			

ENTRY DESCRIPTION

Sub-Index	Access	PDO Mapping	Value Range	Default Value
00 _h	rw	no	0, 164, 181	0

When using PPS units the full velocity range cannot be used in velocity mode. Use profile velocity mode instead.

5.1.19 Object 208E_h, 228E_h, and 248E_h: Acceleration Dimension Index

With these objects, the unit for acceleration can be read out for each axis. The units can be set using objects 208C_h/228C_h/248C_h (5.1.18).

The *acceleration dimension index* objects read 0 when internal units are selected. They read 177 when RPM/s is selected, and the value for PPS/s is 179 then.

OBJECT DESCRIPTION

Index	Name	Object Code	Data Type
208E _h (motor 0) 228E _h (motor 1) 248E _h (motor 2)	Acceleration dimension index	Variable	UNSIGNED8

ENTRY DESCRIPTION

Sub-Index	Access	PDO Mapping	Value Range	Default Value
00 _h	ro	no	0, 177, 179	0

5.1.20 Object 2100_h, 2300_h, and 2500_h: Home Offset Display

These objects show the home offset (4.3.4.4). The value is given in microsteps.

OBJECT DESCRIPTION

Index	Name	Object Code	Data Type
2100 _h (motor 0) 2300 _h (motor 1) 2500 _h (motor 2)	Home offset display	Variable	SIGNED32

ENTRY DESCRIPTION

Sub-Index	Access	PDO Mapping	Value Range	Default Value
00 _h	ro	no	Refer to <i>home offset</i>	0

5.1.21 Object 2101_h, 2301_h, and 2501_h: Actual stallGuard™ Load Value

This object shows the actual stallGuard load value. It is needed for configuring the stallGuard feature, to find the optimal velocity (please see the TMCL manual for more about using stallGuard.)

OBJECT DESCRIPTION

Index	Name	Object Code	Data Type
2101 _h (motor 0) 2301 _h (motor 1) 2501 _h (motor 2)	Actual stallGuard™ load value	Variable	UNSIGNED8

ENTRY DESCRIPTION

Sub-Index	Access	PDO Mapping	Value Range	Default Value
00 _h	ro	no	0... 7	0

5.1.22 Object 2102_h, 2302_h, and 2502_h: Driver Error Flags

This object shows the hardware error flags of the motor driver IC.

THERE ARE THE FOLLOWING ERROR BITS:

Bit	Name	Function	Remark
7	OT	Overtemperature	1 = chip of due to overtemperature
6	OTPW	Temperature prewarning	1= prewarning temperature exceeded
5	UV	Driver undervoltage	1 = undervoltage on VS
4	OCHS	Overcurrent high side	3 PWM cycles with overcurrent within 63 PWM cycles
3	OLB	Open load bridge B	No PWM switch off for 14 oscillator cycles
2	OLA	Open load bridge A	No PWM switch off for 14 oscillator cycles
1	OCB	Overcurrent bridge B low side	3 PWM cycles with overcurrent within 63 PWM cycles
0	OCA	Overcurrent bridge A low side	3 PWM cycles with overcurrent within 63 PWM cycles

OBJECT DESCRIPTION

Index	Name	Object Code	Data Type
2102 _h (motor 0)	Driver error flags	Variable	UNSIGNED8
2302 _h (motor 1)			
2502 _h (motor 2)			

ENTRY DESCRIPTION

Sub-Index	Access	PDO Mapping	Value Range	Default Value
00 _h	ro	no	0... 255	0

5.1.23 Object 2103_h, 2303_h, and 2503_h: Pulse Divisor Display

The pulse divisor display shows the pulse divisor that has been calculated by the drive when user units are selected or that can be set using object 2086_h/2286_h/2486_h when internal units are selected.

OBJECT DESCRIPTION

Index	Name	Object Code	Data Type
2103 _h (motor 0)	Pulse divisor display	Variable	UNSIGNED8
2303 _h (motor 1)			
2503 _h (motor 2)			

ENTRY DESCRIPTION

Sub-Index	Access	PDO Mapping	Value Range	Default Value
00 _h	ro	no	0... 13	3

5.1.24 Object 2104_h, 2304_h, and 2504_h: Maximum Velocity Display

These objects show the values of the objects 2087_h/2287_h/2487_h (5.1.16).

OBJECT DESCRIPTION

Index	Name	Object Code	Data Type
2104 _h (motor 0)	Maximum velocity display	Variable	UNSIGNED32
2304 _h (motor 1)			
2504 _h (motor 2)			

ENTRY DESCRIPTION

Sub-Index	Access	PDO Mapping	Value Range	Default Value
00 _h	ro	no	0... 2047	2047

5.1.25 Object 2105_h, 2305_h, and 2505_h: Ramp Divisor Display

The ramp divisor display shows the ramp divisor that has been calculated by the drive when user units are selected or that can be set using objects 2085_h/2285_h/2485_h (5.1.14) when internal units are selected.

OBJECT DESCRIPTION

Index	Name	Object Code	Data Type
2105 _h (motor 0)	Ramp divisor display	Variable	UNSIGNED8
2305 _h (motor 1)			
2505 _h (motor 2)			

ENTRY DESCRIPTION

Sub-Index	Access	PDO Mapping	Value Range	Default Value
00 _h	ro	no	0... 13	7

5.1.26 Object 2106_h, 2306_h, and 2506_h: Maximum Acceleration Display

These objects show the values of objects 2088_h/2288_h/2488_h (5.1.17).

OBJECT DESCRIPTION

Index	Name	Object Code	Data Type
2106 _h (motor 0)	Maximum acceleration display	Variable	UNSIGNED32
2306 _h (motor 1)			
2506 _h (motor 2)			

ENTRY DESCRIPTION

Sub-Index	Access	PDO Mapping	Value Range	Default Value
00 _h	ro	no	0... 2047	2047

5.1.27 Object 2107_h, 2307_h, and 2507_h: Microstep Resolution Display

These objects show the microstep resolution set by objects 2000_h/2200_h/2400_h (5.1.1) when internal units are selected or calculated when user units are selected.

OBJECT DESCRIPTION

Index	Name	Object Code	Data Type
2107 _h (motor 0)	Microstep resolution display	Variable	UNSIGNED8
2307 _h (motor 1)			
2507 _h (motor 2)			

ENTRY DESCRIPTION

Sub-Index	Access	PDO Mapping	Value Range	Default Value
00 _h	ro	no	0... 8	6

5.1.28 Object 2700_h: TMCL™ Direct Communication

After writing the *make signature* 656b616d_h to this object the drive switches to TMCL mode. The drive can then only be controlled via TMCL commands written to the *OS command* object 1023/01_h

OBJECT DESCRIPTION

Index	Name	Object Code	Data Type
2700 _h	Microstep resolution display	Variable	UNSIGNED32

ENTRY DESCRIPTION

Sub-Index	Access	PDO Mapping	Value Range	Default Value
00 _h	ro	no	Make signature 656b616d _h	0

The drive has to be reset (using the *DS-301 reset application command*) to return to normal CANopen functionality. Then, the parameters of the manufacturer specific profile area and of the standardized device profile area are set to their power-on values.

5.1.29 Object 2701_h: Manufacturer Specific Mode

Writing the *make signature* to this object turns on the manufacturer specific mode. The manufacturer specific mode can be turned off again by writing the *kill signature* to this object.

<u>read</u> :	0 = manufacturer specific mode is inactive 1 = manufacturer specific mode is active
<u>write</u> :	656b616d _h = make signature 6c6c696b _h = kill signature

THE MANUFACTURER SPECIFIC MODE HAS THE FOLLOWING FEATURES:

- PDOs do not need to be disabled and re-enabled when the PDO mapping is to be changed
- The RTR bit in the COB-ID of PDO definitions is ignored.

OBJECT DESCRIPTION

Index	Name	Object Code	Data Type
2701 _h	Manufacturer specific mode	Variable	UNSIGNED32

ENTRY DESCRIPTION

Sub-Index	Access	PDO Mapping	Value Range	Default Value
00 _h	rw	no	See textbox	0

5.1.30 Object 2702_h: Digital Inputs

Bits 16... 23 of this object reflect the states of the digital inputs (general purpose inputs 0... 8, the number of available inputs depend on the module type).

OBJECT DESCRIPTION

Index	Name	Object Code	Data Type
2702 _h	Digital inputs	Variable	UNSIGNED32

ENTRY DESCRIPTION

Sub-Index	Access	PDO Mapping	Value Range	Default Value
00 _h	ro	no	-	0

5.1.31 Object 2703_h: Digital Outputs

With this object the digital outputs (general purpose outputs) can be set. Bits 16... 23 of sub index 1 switch outputs 0... 8 of the module. Bits 16... 23 of sub index 2 determine which outputs can be switched. The number of available digital outputs depends on the module type.

OBJECT DESCRIPTION

Index	Name	Object Code	Data Type
2703 _h	Digital outputs	Array	

ENTRY DESCRIPTION

Sub-Index	Description	Access	PDO Mapping	Value Range	Default Value
01 _h	Physical outputs	rw	no	UNSIGNED32	0
02 _h	Output mask	rw	no	UNSIGNED32	0

5.1.32 Object 2704_h: CAN Bit Rate

With this object it is possible to change the CAN bit rate. To do this, first write the new value to this object. Then, store the new setting by writing the save signature to object 2706_h. After that, reset the module. The new setting becomes active then.

OBJECT DESCRIPTION

Index	Name	Object Code	Data Type
2704 _h	CAN bit rate load	Variable	UNSIGNED16

ENTRY DESCRIPTION

Sub-Index	Access	PDO Mapping	Value Range	Default Value
00 _h	rw	no	20, 50, 125, 250, 500, 1000	250

HOW TO CHANGE THE CAN BIT RATE:

- Write new bit rate in object 2704_h.
- Write save signature 65766173_h in sub-index 01_h of object 2706_h.
- Reset module.

5.1.33 Object 2705_h: Node ID

On modules that do not have address switches the node ID can be selected using this object. On modules with address switches the node ID is normally selected using the address switches. Only when the address switches are set to an invalid value (0 or >127) this object overrides the address switch setting.

To change the node ID, first write the new node ID to this object. Then, store the new setting by writing the save signature to object 2706_h. After that, reset the module. The new setting becomes active now.

OBJECT DESCRIPTION

Index	Name	Object Code	Data Type
2705 _h	Node ID load	Variable	UNSIGNED8

ENTRY DESCRIPTION

Sub-Index	Access	PDO Mapping	Value Range	Default Value
00 _h	rw	no	1... 127	1

HOW TO CHANGE THE NODE ID:

- Write new node ID in object 2705_h.
- Write save signature 65766173_h in sub-index 01_h of object 2706_h.
- Reset module.

5.1.34 Object 2706_h: Store

Writing the save signature to this object permanently saves changes made on objects 2707_h and 2708_h.

Save signature: 65766173_h

OBJECT DESCRIPTION

Index	Name	Object Code	Data Type
2706 _h	Store	Variable	UNSIGNED32

ENTRY DESCRIPTION

Sub-Index	Access	PDO Mapping	Value Range	Default Value
00 _h	ro	no	Highest sub-index supported	1
01 _h	rw	no	Save signature	0

5.1.35 Object 2707_h: CAN bit Rate Load

This object shows the selected CAN bit rate.

OBJECT DESCRIPTION

Index	Name	Object Code	Data Type
2707 _h	CAN bit rate	Variable	UNSIGNED16

ENTRY DESCRIPTION

Sub-Index	Access	PDO Mapping	Value Range	Default Value
00 _h	ro	no	20, 50, 125, 250, 500, 800, 1000	1000

5.1.36 Object 2708_h: Node ID load

This object shows the selected node ID.

OBJECT DESCRIPTION

Index	Name	Object Code	Data Type
2708 _h	Node ID	Variable	UNSIGNED8

ENTRY DESCRIPTION

Sub-Index	Access	PDO Mapping	Value Range	Default Value
00 _h	ro	no	1... 127	Depends on ID switches

5.1.37 Object 2709_h: Encoder Interface

This object defines whether the optional encoder interface (TMC343 module) is used with the module. Only the values 0 (no encoder interface) or 1 (use encoder interface) are possible. The value is automatically stored in the non volatile memory. After changing this object, a reset (*power cycle, reset pulse or reset application*) command is needed.

OBJECT DESCRIPTION

Index	Name	Object Code	Data Type
2709 _h	Encoder interface	Variable	UNSIGNED8

ENTRY DESCRIPTION

Sub-Index	Access	PDO Mapping	Value Range	Default Value
00 _h	rw	no	0/1	0

5.1.38 Object 270A_h: Encoder Interface Display

This object provides the encoder interface setting that is used at the moment (0 or 1).

OBJECT DESCRIPTION

Index	Name	Object Code	Data Type
270A _h	Encoder interface display	Variable	UNSIGNED8

ENTRY DESCRIPTION

Sub-Index	Access	PDO Mapping	Value Range	Default Value
00 _h	ro	no	0/1	0

5.1.39 Object 270E_h: Device Analog Inputs

This object provides the values of the analog inputs of the device (assumed that the device is equipped with analogue inputs).

Please note, that the readout value of analog inputs that are not supported by a specific module is always 0.

OBJECT DESCRIPTION

Index	Name	Object Code	Data Type
270E _h	Device Analog Inputs	Variable	UNSIGNED32

ENTRY DESCRIPTION

Sub-Index	Access	PDO Mapping	Value Range	Default Value
00 _h	ro	no	Highest sub-index	8
01 _h	ro	no	0..1023	0
02 _h	ro	no	0..1023	0
03 _h	ro	no	0..1023	0
04 _h	ro	no	0..1023	0
05 _h	ro	no	0..1023	0
06 _h	ro	no	0..1023	0
07 _h	ro	no	0..1023	0
08 _h	ro	no	0..1023	0

5.1.40 Object 2710_h: Pull-up Resistors (TMCM-351 only)

This object switches the pull-up resistors of the inputs on or off (each bit switches the pull-up resistor of one general purpose input of the TMCM--351).

OBJECT DESCRIPTION

Index	Name	Object Code	Data Type
2710 _h	Pull-up resistors	Variable	UNSIGNED8

ENTRY DESCRIPTION

Sub-Index	Access	PDO Mapping	Value Range	Default Value
00 _h	rw	no	0..255	0

6 Emergency Messages

The module sends an emergency message if an error occurs. The message contains information about the error type. The module can map internal errors. Object 1001_h (error register) is part of every emergency object.

Please note, that the additional byte 2 shows which motor is affected.

ERROR CODES FOR TMC341/342/343 AND TMC351:

Error code	Add. Byte					Description
	1	2	3	4	5	
0x0000	0	0/1/2	0	0	0	Fault reset The fault reset command has been executed.
0x1000	1	0/1/2	0	0	0	Generic error: open load bridge A The motor driver indicates open load on bridge A. It is possible that the motor cable is broken or that there is an error in the power amplifier itself.
0x1000	2	0/1/2	0	0	0	Generic error: open load bridge B The motor driver indicates open load on bridge B. It is possible that the motor cable is broken or that there is an error in the power amplifier itself.
0x2310	0	0/1/2	0	0	0	Overcurrent high side The motor driver indicates an overcurrent on the high side. This can be caused by a short circuit in the driver stage.
0x2311	0	0/1/2	0	0	0	Overcurrent bridge B The motor driver indicates that there is overcurrent on bridge B. This can be caused by a short circuit in the motor itself or in the motor driver stage.
0x2312	0	0/1/2	0	0	0	Overcurrent bridge A The motor driver indicates that there is overcurrent on bridge A. This can be caused by a short circuit in the motor itself or in the motor driver stage.
0x3230	0	0/1/2	0	0	0	stallGuard™ error The actual load value exceeds the stallGuard2 limit.
0x4310	1	0/1/2	0	0	0	Overtemperature pre-warning The temperature in the motor driver exceeds the pre-warning limit.
0x4310	2	0/1/2	0	0	0	Overtemperature error The motor driver has been switched off because the temperature limit has been exceeded.
0x5441	0	255	0	0	0	Shutdown switch active The enable signal is missing (due to the shutdown switch) and the motor driver has been switched off.
0x6320	0	255	0	0	0	Parameter error The data in the received PDO is either wrong or cannot be accepted due to the internal state of the drive.
0x8110	1	255	0	0	0	CAN controller overflow The receive message buffer of the CAN controller hardware is full and some CAN messages are lost.
0x81110	2	255	0	0	0	CAN Tx buffer overflow The software CAN transmit buffer is full and thus some CAN messages are lost.
0x81110	3	255	0	0	0	CAN Rx buffer overflow The software CAN receive buffer is full and so some CAN messages are lost.
0x8120	0	255	0	0	0	CAN error passive The CAN controller has detected communication errors and has entered the CAN Error passive state.
0x8140	0	255	0	0	0	CAN controller recovered from bus-off state The CAN controller had detected too many errors and had changed into the bus-off state. The drive has been stopped and disabled. This message is sent after the CAN controller has recovered from bus-off state and is bus-on again.
0x8611	0	0/1/2	0	0	0	Following error The deviation between motor position counter and encoder position counter has exceeded the following error window.
0xff00	0	0/1/2	0	0	0	Undervoltage The supply voltage is too low to drive a motor.
0xff01	1	0/1/2	0	0	0	Positive software limit The actual position is outside the range defined by object 0x607d.

Error code	Add. Byte					Description
	1	2	3	4	5	
0xff01	2	0/1/2	0	0	0	Negative software limit The actual position is outside the range defined by object 0x607d.
0xff01	3	0/1/2	0	0	0	Positive limit switch The positive limit switch has been touched outside of the homing function.
0xff01	4	0/1/2	0	0	0	Negative limit switch The negative limit switch has been touched outside of the homing function.

7 Life Support Policy

TRINAMIC Motion Control GmbH & Co. KG does not authorize or warrant any of its products for use in life support systems, without the specific written consent of TRINAMIC Motion Control GmbH & Co. KG.

Life support systems are equipment intended to support or sustain life, and whose failure to perform, when properly used in accordance with instructions provided, can be reasonably expected to result in personal injury or death.

© TRINAMIC Motion Control GmbH & Co. KG 2008-2014

Information given in this data sheet is believed to be accurate and reliable. However neither responsibility is assumed for the consequences of its use nor for any infringement of patents or other rights of third parties, which may result from its use.

Specifications are subject to change without notice.

All trademarks used are property of their respective owners.



8 Revision History

8.1 Firmware revision

Version	Date	Author	Description
2.50	2008-OCT-31	OK	First release
3.01	2009-OCT-12	OK	Node ID and bitrate can be configured via manufacturer specific objects Limit switch polarity can be configured via object 2005 _h
3.02	2010-JAN-07	OK	Home switch polarity switchable (via object 2005 _h)
3.05	2010-DEC-15	OK	Heartbeat consumer functionality added Non volatile storage of some motor parameters added Analog inputs can be read via object 270E _h
3.16	2013-APR-18	OK	Not deployed.
3.17		OK	Not deployed.
3.18	25.04.2014	OK	<i>Attention!</i> Per default, the encoder is not active. Set the sensor selection code (object 606A _h) to meet your needs. Profile velocity mode added. New or modified objects: <ul style="list-style-type: none"> - 100C_h guard time - 100D_h life time factor - 1010_h store parameters - 204E_h boost current - 2089_h standby delay - 2108_h absolute resolver value - 6098_h homing methods - 6098_h position encoder resolution - 6098_h encoder prescaler - 2005_h, 2205_h, 2405_h updated
3.20	9.6.2017	OK	Fixed save/restore function. New object 0x2710 (TMCM-351 only).

Table 8.1 Firmware revisions

8.2 Document Revision

Version	Date	Author	Description
0.94	2008-OCT-24	OK	Preliminary version
0.95	2009-FEB-03	OK	Digital Inputs and Outputs added
0.97	2009-OCT-15	OK	Homing methods corrected, objects 1014 _h / 1015 _h / 1017 _h corrected
1.00	2010-MAR-31	SD	Initial version
1.01	2010-May-24	SD	Objects 2704 _h , 2705 _h , 2706 _h , 2707 _h , 2708 _h corrected
1.02	2010-JUN-15	SD	Object 2706 _h and object 6098 _h corrected, minor changes
1.03	2010-JUN-21	SD	Value range of object 2005 _h corrected
1.04	2011-AUG-01	SD	New front, new objects: 1010 _h , 1011 _h , and 1016 _h
2.00	2014-MAY-30	SD	<p><i>Attention!</i> Per default, the encoder is not active. Set the sensor selection code (object 606A_h) to meet your needs.</p> <ul style="list-style-type: none"> - Profile velocity mode added. - Some object descriptions shifted because of new profile velocity mode. - New front design. - Features of modules delighted. Refer to hardware manual please. - 100C_h guard time new. - 100D_h life time factor new. - 605A_h quick stop option code updated. - 6060_h, 6860_h, 7060_h modes of operation updated. - 6061_h, 6861_h, 7061_h modes of operation display updated. - 1010_h (store parameters) and 1011_h (restore parameters) corrected. - 6502_h, 6D02_h, 7502_h supported drive modes updated. - New homing methods added. - 6098_h, 6898_h, 7098_h homing method updated. - 2100_h home offset display new. - 2000_h, 2200_h, 2400_h microstep resolution updated. - 2005_h, 2205_h, 2405_h limit switches updated. - 204E_h boost current new. - 2701_h manufacturer specific mode updated. - Information about features and order codes of the modules erased. Please refer to the hardware manuals.
2.01	2017-JUL-26	OK	Firmware revision 3.20 included.

Table 8.2 Document revisions

9 References

Please refer to www.trinamic.com for the following manuals.

[TMCM-341]	TMCM-341 Hardware Manual and TMCM-341 TMCL Firmware Manual
[TMCM-342]	TMCM-342 Hardware Manual and TMCM-342 TMCL Firmware Manual
[TMCM-343]	TMCM-343 Hardware Manual and TMCM-343 TMCL Firmware Manual
[TMCM-351]	TMCM-351 Hardware Manual and TMCM-351 TMCL Firmware Manual
[BB-301]	BB-301 Manual
[BB-301-S]	BB-301-S Manual
[BB-302]	BB-302 Manual
[BB-303]	BB-303 Manual
[BB-323]	BB-323 Manual
[BB-323-02]	BB-323-02 Manual
[BB-323-03]	BB-323-03 Manual
[TMCM-035]	TMCM-035 Manual
[TMCM-323]	TMCM-323 Manual
[TMCM-EVAL]	TMCM-EVAL Manual
[TMCM-023]	TMCM-023 Manual
[TMCM-078]	TMCM-078 Manual
[PD-013-42]	PD-013-42 Manual
[QSH5718]	QSH5718 Manual
[QSH6018]	QSH6018 Manual