

8-Channel, Low Noise, Low Power, 24-Bit, Sigma-Delta ADC with PGA and Reference

**FEATURES**

- ▶ Functional safety approved to SC3 by TÜV Rheinland, File Number 968/FSP 2188.01/23



- ▶ Three power modes
- ▶ RMS noise
  - ▶ Low power: 24 nV rms at 1.17 SPS, gain = 128 (255  $\mu$ A typical)
  - ▶ Mid power: 20 nV rms at 2.34 SPS, gain = 128 (355  $\mu$ A typical)
  - ▶ Full power: 23 nV rms at 9.4 SPS, gain = 128 (930  $\mu$ A typical)
- ▶ Up to 22 noise free bits in all power modes (gain = 1)
- ▶ Output data rate
  - ▶ Full power: 9.38 SPS to 19,200 SPS
  - ▶ Mid power: 2.34 SPS to 4800 SPS
  - ▶ Low power: 1.17 SPS to 2400 SPS
- ▶ Rail-to-rail analog inputs for gains > 1
- ▶ Simultaneous 50 Hz/60 Hz rejection at 25 SPS (single cycle settling)
- ▶ Diagnostic functions (which aid safe integrity level (SIL) certification)
- ▶ Crosspoint multiplexed analog inputs
  - ▶ 8 differential/15 pseudodifferential inputs
- ▶ Programmable gain (1 to 128)
- ▶ Band gap reference with 15 ppm/ $^{\circ}$ C drift maximum (70  $\mu$ A)

- ▶ Matched programmable excitation currents
- ▶ Internal clock oscillator
- ▶ On-chip bias voltage generator
- ▶ Low-side power switch
- ▶ General-purpose outputs
- ▶ Multiple filter options
- ▶ Internal temperature sensor
- ▶ Self and system calibration
- ▶ Sensor burnout detection
- ▶ Automatic channel sequencer
- ▶ Per channel configuration
- ▶ Power supply: 2.7 V to 3.6 V and  $\pm$ 1.8 V
- ▶ Independent interface power supply
- ▶ Power-down current: 5  $\mu$ A maximum
- ▶ Temperature range:  $-40^{\circ}$ C to  $+125^{\circ}$ C
- ▶ 32-lead LFCSP
- ▶ 3-wire or 4-wire serial interface
  - ▶ SPI, QSPI<sup>™</sup>, MICROWIRE<sup>™</sup>, and DSP compatible
  - ▶ Schmitt trigger on SCLK
- ▶ ESD: 4 kV

**APPLICATIONS**

- ▶ Temperature measurement
- ▶ Pressure measurement
- ▶ Industrial process control
- ▶ Instrumentation
- ▶ Smart transmitters

**FUNCTIONAL BLOCK DIAGRAM**

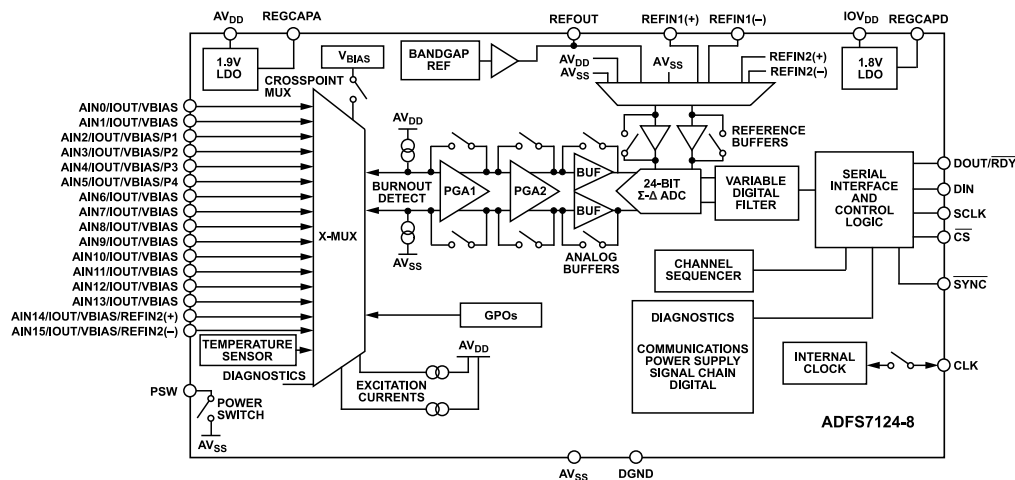

Figure 1. Functional Block Diagram

## TABLE OF CONTENTS

Features.....	1	Fast Settling Mode (Sinc <sup>4</sup> + Sinc <sup>1</sup> Filter).....	60
Applications.....	1	Fast Settling Mode (Sinc <sup>3</sup> + Sinc <sup>1</sup> Filter).....	62
Functional Block Diagram.....	1	Post Filters.....	63
General Description.....	3	Summary of Filter Options.....	66
Specifications.....	4	Diagnostics.....	68
Timing Characteristics.....	10	Signal Chain Check.....	68
Absolute Maximum Ratings .....	13	Reference Detect.....	68
Thermal Resistance.....	13	Calibration, Conversion, and Saturation	
ESD Caution.....	13	Errors.....	68
Pin Configuration and Function Descriptions .....	14	Overvoltage/Undervoltage Detection.....	68
Typical Performance Characteristics.....	17	Power Supply Monitors.....	69
Terminology.....	26	LDO Monitoring.....	69
RMS Noise and Resolution.....	27	MCLK Counter.....	69
Full Power Mode.....	27	SPI SCLK Counter.....	70
Mid Power Mode.....	30	SPI Read/Write Errors.....	70
Low Power Mode.....	33	SPI_IGNORE Error.....	70
Getting Started.....	36	Checksum Protection.....	70
Overview.....	36	Memory Map Checksum Protection.....	70
Power Supplies.....	37	ROM Checksum Protection.....	71
Digital Communication.....	37	Burnout Currents.....	72
Configuration Overview.....	39	Temperature Sensor.....	72
ADC Circuit Information.....	46	Grounding and Layout.....	73
Analog Input Channel.....	46	Applications Information.....	74
Programmable Gain Amplifier (PGA).....	47	Temperature Measurement Using a	
Reference.....	47	Thermocouple.....	74
Bipolar/Unipolar Configuration.....	47	Temperature Measurement Using an RTD.....	75
Data Output Coding.....	48	Flowmeter.....	77
Excitation Currents.....	48	On-Chip Registers.....	79
Bridge Power-Down Switch.....	48	Communications Register.....	80
Logic Outputs.....	48	Status Register.....	80
Bias Voltage Generator.....	49	ADC_CONTROL Register.....	81
Clock.....	49	Data Register.....	83
Power Modes.....	49	IO_CONTROL_1 Register.....	83
Standby and Power-Down Modes.....	49	IO_CONTROL_2 Register.....	85
Digital Interface.....	50	ID Register.....	85
DATA_STATUS.....	52	Error Register.....	85
Serial Interface Reset (DOUT_RDY_DEL		ERROR_EN Register.....	86
and CS_EN Bits).....	52	MCLK_COUNT Register.....	88
Reset.....	52	Channel Registers.....	88
Calibration.....	52	Configuration Registers.....	90
Span and Offset Limits.....	53	Filter Registers.....	91
System Synchronization.....	54	Offset Registers.....	92
Digital Filter.....	55	Gain Registers.....	92
Sinc <sup>4</sup> Filter.....	55	Outline Dimensions.....	93
Sinc <sup>3</sup> Filter.....	57	Ordering Guide.....	93

## GENERAL DESCRIPTION

The ADFS7124-8 is a low power, low noise, completely integrated analog front end for high precision measurement applications. The device contains a low noise, 24-bit  $\Sigma$ - $\Delta$  analog-to-digital converter (ADC), and can be configured to have 8 differential inputs or 15 single-ended or pseudo differential inputs. The on-chip low gain stage ensures that signals of small amplitude can be interfaced directly to the ADC.

One of the major advantages of the ADFS7124-8 is that it gives the user the flexibility to employ one of three integrated power modes. The current consumption, range of output data rates, and RMS noise can be tailored with the power mode selected. The device also offers a multitude of filter options, ensuring the highest degree of flexibility.

The ADFS7124-8 can achieve simultaneous 50 Hz and 60 Hz rejection when operating at an output data rate of 25 SPS (single cycle settling), with rejection in excess of 80 dB achieved at lower output data rates.

The ADFS7124-8 establishes the highest degree of signal chain integration. The device contains a precision, low noise, low drift internal band gap reference and accepts an external differential reference, which can be internally buffered. Other key integrated features include programmable low drift excitation current sources, burnout currents, and a bias voltage generator, which sets the common-mode voltage of a channel to  $AV_{DD}/2$ . The low-side power switch enables the user to power down bridge sensors between conversions, ensuring the absolute minimal power consumption of the system. The device also allows the user the option of operating with either an internal or external clock.

The integrated channel sequencer allows several channels to be enabled simultaneously, and the ADFS7124-8 sequentially converts

on each enabled channel, simplifying communication with the device. As many as 16 channels can be enabled at any time, a channel being defined as an analog input or a diagnostic such as a power supply check or a reference check. This unique feature allows diagnostics to be interleaved with conversions. The ADFS7124-8 also supports per channel configuration. The device allows eight configurations or setups. Each configuration consists of gain, filter type, output data rate, buffering, and reference source. The user can assign any of these setups on a channel-by-channel basis.

The ADFS7124-8 also has extensive diagnostic functionality integrated as part of its comprehensive feature set. These diagnostics include a cyclic redundancy check (CRC), signal chain checks, and serial interface checks, which lead to a more robust solution. These diagnostics reduce the need for external components to implement diagnostics, resulting in reduced board space needs, reduced design cycle times, and cost savings. The failure modes effects and diagnostic analysis (FMEDA) of a typical application has shown a safe failure fraction (SFF) greater than 90% according to IEC 61508.

The device operates with a single analog power supply from 2.7 V to 3.6 V or a dual 1.8 V power supply. The digital supply has a range of 1.65 V to 3.6 V. It is specified for a temperature range of  $-40^{\circ}\text{C}$  to  $+125^{\circ}\text{C}$ . The ADFS7124-8 is housed in a 32-lead LFCSP package.

Note that, throughout this data sheet, multifunction pins, such as  $\overline{\text{DOUT}}/\overline{\text{RDY}}$ , are referred to either by the entire pin name or by a single function of the pin, for example,  $\overline{\text{RDY}}$ , when only that function is relevant.

**Table 1. ADFS7124-8 Overview**

Parameter	Low Power Mode	Mid Power Mode	Full Power Mode
Maximum Output Data Rate	2400 SPS	4800 SPS	19,200 SPS
RMS Noise (Gain = 128)	24 nV	20 nV	23 nV
Peak-to-Peak Resolution at 1200 SPS (Gain = 1)	16.4 bits	17.1 bits	18 bits
Typical Current (ADC + PGA)	255 $\mu\text{A}$	355 $\mu\text{A}$	930 $\mu\text{A}$

## SPECIFICATIONS

$AV_{DD}$  = 2.9 V to 3.6 V (full power mode), 2.7 V to 3.6 V (mid and low power mode),  $IOV_{DD}$  = 1.65 V to 3.6 V,  $AV_{SS}$  = DGND = 0 V,  $REFINx(+)$  = 2.5 V,  $REFINx(-)$  =  $AV_{SS}$ , controller clock = 614.4 kHz, all specifications  $T_{MIN}$  to  $T_{MAX}$ , unless otherwise noted.

Table 2. Specifications

Parameter <sup>1</sup>	Min	Typ	Max	Unit	Test Conditions/Comments
ADC					
Output Data Rate, $f_{ADC}$					
Low Power Mode	1.17		2400	SPS	
Mid Power Mode	2.34		4800	SPS	
Full Power Mode	9.38		19,200	SPS	
No Missing Codes <sup>2</sup>	24			Bits	$FS^3 > 2$ , sinc <sup>4</sup> filter
	24			Bits	$FS^3 > 8$ , sinc <sup>3</sup> filter
Resolution					See the <a href="#">RMS Noise and Resolution</a> section
RMS Noise and Update Rates					See the <a href="#">RMS Noise and Resolution</a> section
Integral Nonlinearity (INL)	-4	±1	+4	ppm of FSR	Gain = 1 <sup>2</sup>
	-15	±2	+15	ppm of FSR	Gain > 1 <sup>4</sup>
Offset Error <sup>5</sup>					
Before Calibration		±15		μV	Gain = 1 to 8
		200/gain		μV	Gain = 16 to 128
After Internal Calibration/System Calibration		In order of noise			
Offset Error Drift vs. Temperature <sup>6</sup>					
Low Power Mode		10		nV/°C	Gain = 1 or gain > 16
		80		nV/°C	Gain = 2 to 8
		40		nV/°C	Gain = 16
Mid Power Mode		10		nV/°C	Gain = 1 or gain > 16
		40		nV/°C	Gain = 2 to 8
		20		nV/°C	Gain = 16
Full Power Mode		10		nV/°C	
Gain Error <sup>5,7</sup>					
Before Internal Calibration	-0.0025		+0.0025	%	Gain = 1, $T_A = 25^\circ\text{C}$
		-0.3		%	Gain > 1
After Internal Calibration	-0.016	+0.004	+0.016	%	Gain = 2 to 8, $T_A = 25^\circ\text{C}$
		±0.025		%	Gain = 16 to 128
After System Calibration		In order of noise			
Gain Error Drift vs. Temperature		1	2	ppm/°C	
Power Supply Rejection					$A_{IN} = 1 \text{ V/gain}$ , external reference
Low Power Mode	87			dB	Gain = 2 to 16
	96			dB	Gain = 1 or gain > 16
Mid Power Mode <sup>2</sup>	92			dB	Gain = 2 to 16
	100			dB	Gain = 1 or gain > 16
Full Power Mode	99			dB	
Common-Mode Rejection <sup>8</sup>					
At DC <sup>2</sup>	85	90		dB	$A_{IN} = 1 \text{ V}$ , gain = 1
At DC	105	115		dB	$A_{IN} = 1 \text{ V/gain}$ , gain 2 or 4
	102 <sup>9,2</sup>			dB	$A_{IN} = 1 \text{ V/gain}$ , gain 2 or 4
	115	120		dB	$A_{IN} = 1 \text{ V/gain}$ , gain ≥ 8
	105 <sup>9,2</sup>			dB	$A_{IN} = 1 \text{ V/gain}$ , gain ≥ 8
Sinc <sup>3</sup> , Sinc <sup>4</sup> Filter <sup>2</sup>					
At 50 Hz, 60 Hz	120			dB	10 SPS, 50 Hz ± 1 Hz, 60 Hz ± 1 Hz
At 50 Hz	120			dB	50 SPS, 50 Hz ± 1 Hz
At 60 Hz	120			dB	60 SPS, 60 Hz ± 1 Hz

## SPECIFICATIONS

Table 2. Specifications (Continued)

Parameter <sup>1</sup>	Min	Typ	Max	Unit	Test Conditions/Comments
Fast Settling Filters <sup>2</sup>					
At 50 Hz	115			dB	First notch at 50 Hz, 50 Hz ± 1 Hz
At 60 Hz	115			dB	First notch at 60 Hz, 60 Hz ± 1 Hz
Post Filters <sup>2</sup>					
At 50 Hz, 60 Hz	130			dB	20 SPS, 50 Hz ± 1 Hz, 60 Hz ± 1 Hz
	130			dB	25 SPS, 50 Hz ± 1 Hz, 60 Hz ± 1 Hz
Normal Mode Rejection <sup>2</sup>					
Sinc <sup>4</sup> Filter					
External Clock					
At 50 Hz, 60 Hz	120			dB	10 SPS, 50 Hz ± 1 Hz, 60 Hz ± 1 Hz
	80			dB	50 SPS, REJ60 <sup>10</sup> = 1, 50 Hz ± 1 Hz, 60 Hz ± 1 Hz
At 50 Hz	120			dB	50 SPS, 50 Hz ± 1 Hz
At 60 Hz	120			dB	60 SPS, 60 Hz ± 1 Hz
Internal Clock					
At 50 Hz, 60 Hz	98			dB	10 SPS, 50 Hz ± 1 Hz, 60 Hz ± 1 Hz
	66			dB	50 SPS, REJ60 <sup>10</sup> = 1, 50 Hz ± 1 Hz, 60 Hz ± 1 Hz
At 50 Hz	92			dB	50 SPS, 50 Hz ± 1 Hz
At 60 Hz	92			dB	60 SPS, 60 Hz ± 1 Hz
Sinc <sup>3</sup> Filter					
External Clock					
At 50 Hz, 60 Hz	100			dB	10 SPS, 50 Hz ± 1 Hz, 60 Hz ± 1 Hz
	65			dB	50 SPS, REJ60 <sup>10</sup> = 1, 50 Hz ± 1 Hz, 60 Hz ± 1 Hz
At 50 Hz	100			dB	50 SPS, 50 Hz ± 1 Hz
At 60 Hz	100			dB	60 SPS, 60 Hz ± 1 Hz
Internal Clock					
At 50 Hz, 60 Hz	73			dB	10 SPS, 50 Hz ± 1 Hz, 60 Hz ± 1 Hz
	52			dB	50 SPS, REJ60 <sup>10</sup> = 1, 50 Hz ± 1 Hz, 60 Hz ± 1 Hz
At 50 Hz	68			dB	50 SPS, 50 Hz ± 1 Hz
At 60 Hz	68			dB	60 SPS, 60 Hz ± 1 Hz
Fast Settling Filters					
External Clock					
At 50 Hz	40			dB	First notch at 50 Hz, 50 Hz ± 0.5 Hz
At 60 Hz	40			dB	First notch at 60 Hz, 60 Hz ± 0.5 Hz
Internal Clock					
At 50 Hz	24.5			dB	First notch at 50 Hz, 50 Hz ± 0.5 Hz
At 60 Hz	24.5			dB	First notch at 60 Hz, 60 Hz ± 0.5 Hz
Post Filters					
External Clock					
At 50 Hz, 60 Hz	86			dB	20 SPS, 50 Hz ± 1 Hz, 60 Hz ± 1 Hz
	62			dB	25 SPS, 50 Hz ± 1 Hz, 60 Hz ± 1 Hz
Internal Clock					
At 50 Hz, 60 Hz	67			dB	20 SPS, 50 Hz ± 1 Hz, 60 Hz ± 1 Hz
	50			dB	25 SPS, 50 Hz ± 1 Hz, 60 Hz ± 1 Hz
ANALOG INPUTS <sup>11</sup>					

## SPECIFICATIONS

Table 2. Specifications (Continued)

Parameter <sup>1</sup>	Min	Typ	Max	Unit	Test Conditions/Comments
Differential Input Voltage Ranges <sup>12</sup>		$\pm V_{REF}/\text{gain}$		V	$V_{REF} = \text{REFINx}(+) - \text{REFINx}(-)$ , or internal reference
Absolute $A_{IN}$ Voltage Limits <sup>2</sup>					
Gain = 1 (Unbuffered)	$AV_{SS} - 0.05$		$AV_{DD} + 0.05$	V	
Gain = 1 (Buffered)	$AV_{SS} + 0.1$		$AV_{DD} - 0.1$	V	
Gain > 1	$AV_{SS} - 0.05$		$AV_{DD} + 0.05$	V	
Analog Input Current					
Gain > 1 or Gain = 1 (Buffered)					
Low Power Mode					
Absolute Input Current		$\pm 1$		nA	
Differential Input Current		$\pm 0.2$		nA	
Analog Input Current Drift		25		$\text{pA}/^\circ\text{C}$	
Mid Power Mode					
Absolute Input Current		$\pm 1.2$		nA	
Differential Input Current		$\pm 0.4$		nA	
Analog Input Current Drift		25		$\text{pA}/^\circ\text{C}$	
Full Power Mode					
Absolute Input Current		$\pm 3.3$		nA	
Differential Input Current		$\pm 1.5$		nA	
Analog Input Current Drift		25		$\text{pA}/^\circ\text{C}$	
Gain = 1 (Unbuffered)					Current varies with input voltage
Absolute Input Current		$\pm 2.65$		$\mu\text{A}/\text{V}$	
Analog Input Current Drift		1.1		$\text{nA}/\text{V}/^\circ\text{C}$	
REFERENCE INPUT					
Internal Reference					
Initial Accuracy	2.5 - 0.2%	2.5	2.5 + 0.2%	V	$T_A = 25^\circ\text{C}$
Drift		2	15	$\text{ppm}/^\circ\text{C}$	$T_A = -40^\circ\text{C}$ to $+125^\circ\text{C}$
Output Current			10	mA	
Load Regulation		50		$\mu\text{V}/\text{mA}$	
Power Supply Rejection		85		dB	
External Reference					
External REFIN Voltage <sup>2</sup>	0.5	2.5	$AV_{DD}$	V	$\text{REFIN} = \text{REFINx}(+) - \text{REFINx}(-)$
Absolute REFIN Voltage Limits <sup>2</sup>	$AV_{SS} - 0.05$		$AV_{DD} + 0.05$	V	Unbuffered
	$AV_{SS} + 0.1$		$AV_{DD} - 0.1$	V	Buffered
Reference Input Current					
Buffered					
Low Power Mode					
Absolute Input Current		$\pm 0.5$		nA	
Reference Input Current Drift		10		$\text{pA}/^\circ\text{C}$	
Mid Power Mode					
Absolute Input Current		$\pm 1$		nA	
Reference Input Current Drift		10		$\text{pA}/^\circ\text{C}$	
Full Power Mode					
Absolute Input Current		$\pm 3$		nA	
Reference Input Current Drift		10		$\text{pA}/^\circ\text{C}$	
Unbuffered					
Absolute Input Current		$\pm 12$		$\mu\text{A}$	
Reference Input Current Drift		6		$\text{nA}/^\circ\text{C}$	
Normal Mode Rejection					Same as for analog inputs

## SPECIFICATIONS

Table 2. Specifications (Continued)

Parameter <sup>1</sup>	Min	Typ	Max	Unit	Test Conditions/Comments
Common-Mode Rejection		100		dB	
EXCITATION CURRENT SOURCES (IOUT0/IOUT1)					Available on any analog input pin
Output Current		0.1/50/100/250/ 500/750/1000		μA	
Initial Tolerance		±4		%	T <sub>A</sub> = 25°C
Drift		50		ppm/°C	
Current Matching		±0.5		%	Matching between IOUT0 and IOUT1, V <sub>OUT</sub> = 0 V
Drift Matching <sup>2</sup>		5	30	ppm/°C	
Line Regulation (AV <sub>DD</sub> )		2		%/V	AV <sub>DD</sub> = 3 V ± 5%
Load Regulation		0.2		%/V	
Output Compliance <sup>2</sup>	AV <sub>SS</sub> - 0.05		AV <sub>DD</sub> - 0.37	V	50 μA/100 μA/250 μA/500 μA current sources, 2% accuracy
	AV <sub>SS</sub> - 0.05		AV <sub>DD</sub> - 0.48	V	750 μA and 1000 μA current sources, 2% accuracy
BIAS VOLTAGE (V <sub>BIAS</sub> ) GENERATOR					Available on any analog input pin
V <sub>BIAS</sub>		AV <sub>SS</sub> + (AV <sub>DD</sub> - AV <sub>SS</sub> )/2		V	
V <sub>BIAS</sub> Generator Start-Up Time		6.7		μs/nF	Dependent on the capacitance connected to AINx
TEMPERATURE SENSOR					
Accuracy		±0.5		°C	
Sensitivity		13,584		codes/°C	
LOW-SIDE POWER SWITCH					
On Resistance (R <sub>ON</sub> )		7	10	Ω	
Allowable Current <sup>2</sup>			30	mA	Continuous current
BURNOUT CURRENTS					
A <sub>IN</sub> Current		0.5/2/4		μA	Analog inputs must be buffered
DIGITAL OUTPUTS (P1 to P4)					
Output Voltage					
High, V <sub>OH</sub>	AV <sub>DD</sub> - 0.6			V	I <sub>SOURCE</sub> = 100 μA
Low, V <sub>OL</sub>			0.4	V	I <sub>SINK</sub> = 100 μA
DIAGNOSTICS					
Power Supply Monitor Detect Level					
Analog Low Dropout Regulator (ALDO)			1.6	V	AV <sub>DD</sub> - AV <sub>SS</sub> ≥ 2.7 V
Digital LDO (DLDO)			1.55	V	IOV <sub>DD</sub> ≥ 1.75 V
Reference Detect Level	0.7		1	V	REF_DET_ERR bit active if V <sub>REF</sub> < 0.7 V
AINM/AINP Overvoltage Detect Level	AV <sub>DD</sub> + 0.04			V	
AINM/AINP Undervoltage Detect Level			AV <sub>SS</sub> - 0.04	V	
INTERNAL/EXTERNAL CLOCK					
Internal Clock					
Frequency	614.4 - 5%	614.4	614.4 + 5%	kHz	
Duty Cycle		50:50		%	
External Clock					
Frequency		2.4576		MHz	Internal divide by 4
Duty Cycle Range		45:55 to 55:45		%	
LOGIC INPUTS <sup>2</sup>					
Input Voltage					
Low, V <sub>INL</sub>			0.3 × IOV <sub>DD</sub>	V	1.65 V ≤ IOV <sub>DD</sub> < 1.9 V

## SPECIFICATIONS

Table 2. Specifications (Continued)

Parameter <sup>1</sup>	Min	Typ	Max	Unit	Test Conditions/Comments
High, $V_{INH}$			$0.35 \times IOV_{DD}$	V	$1.9 V \leq IOV_{DD} < 2.3 V$
			0.7	V	$2.3 V \leq IOV_{DD} \leq 3.6 V$
		$0.7 \times IOV_{DD}$		V	$1.65 V \leq IOV_{DD} < 1.9 V$
		$0.65 \times IOV_{DD}$		V	$1.9 V \leq IOV_{DD} < 2.3 V$
		1.7		V	$2.3 V \leq IOV_{DD} < 2.7 V$
		2		V	$2.7 V \leq IOV_{DD} \leq 3.6 V$
Hysteresis	0.2		0.6	V	$1.65 V \leq IOV_{DD} \leq 3.6 V$
Input Currents	-1		+1	$\mu A$	$V_{IN} = IOV_{DD}$ or GND
Input Capacitance		10		pF	All digital inputs
LOGIC OUTPUTS (INCLUDING CLK)					
Output Voltage <sup>2</sup>					
High, $V_{OH}$	$IOV_{DD} - 0.35$			V	$I_{SOURCE} = 100 \mu A$
Low, $V_{OL}$			0.4	V	$I_{SINK} = 100 \mu A$
Floating State Leakage Current	-1		+1	$\mu A$	
Floating State Output Capacitance		10		pF	
Data Output Coding		Offset binary			
SYSTEM CALIBRATION <sup>2</sup>					
Calibration Limit					
Full-Scale			$1.05 \times FS$	V	
Zero-Scale	$-1.05 \times FS$			V	
Input Span	$0.8 \times FS$		$2.1 \times FS$	V	
POWER SUPPLY VOLTAGES FOR ALL POWER MODES					
$AV_{DD}$ to $AV_{SS}$					
Low Power Mode	2.7		3.6	V	
Mid Power Mode	2.7		3.6	V	
Full Power Mode	2.9		3.6	V	
$IOV_{DD}$ to GND	1.65		3.6	V	
$AV_{SS}$ to GND	-1.8		0	V	
$IOV_{DD}$ to $AV_{SS}$			5.4	V	
POWER SUPPLY CURRENTS <sup>11, 13</sup>					
$I_{AVDD}$ , External Reference					
Low Power Mode					
Gain = $1^2$		125	140	$\mu A$	All buffers off
Gain = 1 $I_{AVDD}$ Increase per AINx Buffer <sup>2</sup>		15	25	$\mu A$	
Gain = 2 to 8		205	250	$\mu A$	
Gain = 16 to 128		235	300	$\mu A$	
$I_{AVDD}$ Increase per Reference Buffer <sup>2</sup>		10	20	$\mu A$	All gains
Mid Power Mode					
Gain = $1^2$		150	170	$\mu A$	All buffers off
Gain = 1 $I_{AVDD}$ Increase per AINx Buffer <sup>2</sup>		30	40	$\mu A$	
Gain = 2 to 8		275	345	$\mu A$	
Gain = 16 to 128		330	430	$\mu A$	
$I_{AVDD}$ Increase per Reference Buffer <sup>2</sup>		20	30	$\mu A$	All gains
Full Power Mode					
Gain = $1^2$		315	350	$\mu A$	All buffers off
Gain = 1 $I_{AVDD}$ Increase per AINx Buffer <sup>2</sup>		90	135	$\mu A$	
Gain = 2 to 8		660	830	$\mu A$	
Gain = 16 to 128		875	1200	$\mu A$	



## SPECIFICATIONS

Table 2. Specifications (Continued)

Parameter <sup>1</sup>	Min	Typ	Max	Unit	Test Conditions/Comments
$I_{AVDD}$ Increase per Reference Buffer <sup>2</sup>		85	120	$\mu\text{A}$	All gains
$I_{AVDD}$ Increase Due to Internal Reference <sup>2</sup>		50	70	$\mu\text{A}$	Independent of power mode; the reference buffers are not required when using this reference
Due to $V_{BIAS}$ <sup>2</sup>		15	20	$\mu\text{A}$	Independent of power mode
Due to Diagnostics <sup>2</sup>		4	5	$\mu\text{A}$	
$I_{IOVDD}$					
Low Power Mode		20	35	$\mu\text{A}$	
Mid Power Mode		25	40	$\mu\text{A}$	
Full Power Mode		55	80	$\mu\text{A}$	
POWER-DOWN CURRENTS <sup>13</sup>					Independent of power mode
Standby Current					
$I_{AVDD}$		7	15	$\mu\text{A}$	LDOs on only
$I_{IOVDD}$		8	20	$\mu\text{A}$	
Power-Down Current					
$I_{AVDD}$		1	3	$\mu\text{A}$	
$I_{IOVDD}$		1	2	$\mu\text{A}$	

<sup>1</sup> Temperature range =  $-40^{\circ}\text{C}$  to  $+125^{\circ}\text{C}$ .

<sup>2</sup> These specifications are not production tested but are supported by characterization data at the initial product release.

<sup>3</sup> FS is the decimal equivalent of the FS[10:0] bits in the filter registers.

<sup>4</sup> The nonlinearity is production tested in full power mode. For the other power modes, this specification is supported by characterization data at the initial product release.

<sup>5</sup> Following a system or internal zero-scale calibration, the offset error is in the order of the noise for the programmed gain and output data rate selected. A system full-scale calibration reduces the gain error to the order of the noise for the programmed gain and output data rate.

<sup>6</sup> Recalibration at any temperature removes these errors.

<sup>7</sup> Gain error applies to both positive and negative full-scale. A factory calibration is performed at gain = 1,  $T_A = 25^{\circ}\text{C}$ .

<sup>8</sup> When gain > 1, the common-mode voltage is between  $(AV_{SS} + 0.1 + 0.5/\text{gain})$  and  $(AV_{DD} - 0.1 - 0.5/\text{gain})$ .

<sup>9</sup> Specification is for a wider common-mode voltage between  $(AV_{SS} - 0.05 + 0.5/\text{gain})$  and  $(AV_{DD} - 0.1 - 0.5/\text{gain})$ .

<sup>10</sup> REJ60 is a bit in the filter registers. When the first notch of the sinc filter is at 50 Hz, a notch is placed at 60 Hz when REJ60 is set to 1. This gives simultaneous 50 Hz and 60 Hz rejection.

<sup>11</sup> When the gain is greater than 1, the analog input buffers are enabled automatically. The buffers can only be disabled when the gain equals 1.

<sup>12</sup> When  $V_{REF} = (AV_{DD} - AV_{SS})$ , the typical differential input equals  $0.92 \times V_{REF}/\text{gain}$  for the low and mid power modes and  $0.86 \times V_{REF}/\text{gain}$  for full power mode when gain > 1.

<sup>13</sup> The digital inputs are equal to  $IOV_{DD}$  or DGND with excitation currents and bias voltage generator disabled.

## SPECIFICATIONS

## TIMING CHARACTERISTICS

$AV_{DD} = 2.9\text{ V to }3.6\text{ V}$  (full power mode),  $2.7\text{ V to }3.6\text{ V}$  (mid and low power mode),  $IOV_{DD} = 1.65\text{ V to }3.6\text{ V}$ ,  $AV_{SS} = \text{DGND} = 0\text{ V}$ , Input Logic 0 = 0 V, Input Logic 1 =  $IOV_{DD}$ , unless otherwise noted.

Table 3. Timing Characteristics

Parameter <sup>1, 2</sup>	Min	Typ	Max	Unit	Test Conditions/Comments
$t_3$	100			ns	SCLK high pulse width
$t_4$	100			ns	SCLK low pulse width
$t_{12}$					Delay between consecutive read/write operations
	3/MCLK <sup>3</sup>			ns	Full power mode
	12/MCLK			ns	Mid power mode
	24/MCLK			ns	Low power mode
$t_{13}$				$\mu\text{s}$	DOUT/ high time if DOUT/ $\overline{\text{RDY}}$ is low and the next conversion is available
		6		$\mu\text{s}$	Full power mode
		25		$\mu\text{s}$	Mid power mode
		50		$\mu\text{s}$	Low power mode
$t_{14}$					$\overline{\text{SYNC}}$ low pulse width
	3/MCLK			ns	Full power mode
	12/MCLK			ns	Mid power mode
	24/MCLK			ns	Low power mode
READ OPERATION					
$t_1$	0		80	ns	$\overline{\text{CS}}$ falling edge to DOUT/ $\overline{\text{RDY}}$ active time
$t_2^4$	0		80	ns	SCLK active edge <sup>5</sup> to data valid delay
$t_5^{6, 7}$	10		80	ns	Bus relinquish time after $\overline{\text{CS}}$ inactive edge
$t_6$	0			ns	SCLK inactive edge to $\overline{\text{CS}}$ inactive edge
$t_7^8$					SCLK inactive edge to DOUT/ $\overline{\text{RDY}}$ high
	10			ns	The DOUT_ $\overline{\text{RDY}}$ _DEL bit is cleared, the $\overline{\text{CS}}$ _EN bit is cleared
	110			ns	The DOUT_ $\overline{\text{RDY}}$ _DEL bit is set, the $\overline{\text{CS}}$ _EN bit is cleared
$t_{7A}^7$	$t_5$			ns	Data valid after $\overline{\text{CS}}$ inactive edge, the $\overline{\text{CS}}$ _EN bit is set
WRITE OPERATION					
$t_8$	0			ns	$\overline{\text{CS}}$ falling edge to SCLK active edge <sup>5</sup> setup time
$t_9$	30			ns	Data valid to SCLK edge setup time
$t_{10}$	25			ns	Data valid to SCLK edge hold time
$t_{11}$	0			ns	$\overline{\text{CS}}$ rising edge to SCLK edge hold time

<sup>1</sup> These specifications were sample tested during the initial release to ensure compliance. All input signals are specified with  $t_R = t_F = 5\text{ ns}$  (10% to 90% of  $IOV_{DD}$  and timed from a voltage level of  $IOV_{DD}/2$ .

<sup>2</sup> See Figure 3, Figure 4, Figure 5, and Figure 6.

<sup>3</sup> MCLK is the controller clock frequency.

<sup>4</sup> These specifications are measured with the load circuit shown in Figure 2 and defined as the time required for the output to cross the  $V_{OL}$  or  $V_{OH}$  limits.

<sup>5</sup> The SCLK active edge is the falling edge of SCLK.

<sup>6</sup> These specifications are derived from the measured time taken by the data output to change by 0.5 V when loaded with the circuit shown in Figure 2. The measured number is then extrapolated back to remove the effects of charging or discharging the 25 pF capacitor. The times quoted in the timing characteristics are the true bus relinquish times of the device and, therefore, are independent of external bus loading capacitances.

<sup>7</sup>  $\overline{\text{RDY}}$  returns high after a read of the ADC. In single conversion mode and continuous conversion mode, the same data can be read again, if required, while  $\overline{\text{RDY}}$  is high, although subsequent reads must not occur close to the next output update. In continuous read mode, the digital word can be read only once.

<sup>8</sup> When the  $\overline{\text{CS}}$ \_EN bit is cleared, the DOUT/ $\overline{\text{RDY}}$  pin changes from its DOUT function to its  $\overline{\text{RDY}}$  function, following the last inactive edge of the SCLK. When  $\overline{\text{CS}}$ \_EN is set, the DOUT pin continues to output the LSB of the data until the  $\overline{\text{CS}}$  inactive edge.

SPECIFICATIONS

Timing Diagrams

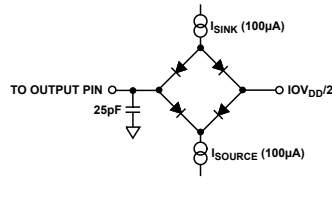

Figure 2. Load Circuit for Timing Characterization

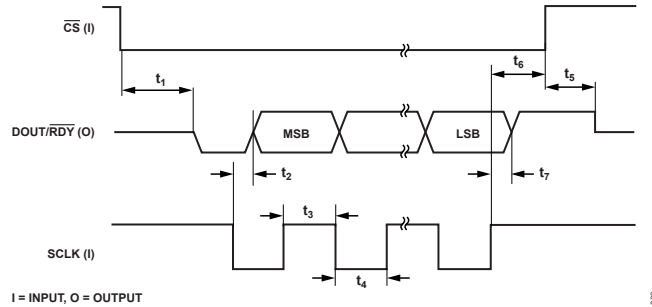

Figure 3. Read Cycle Timing Diagram ( $\overline{CS\_EN}$  Bit Cleared)

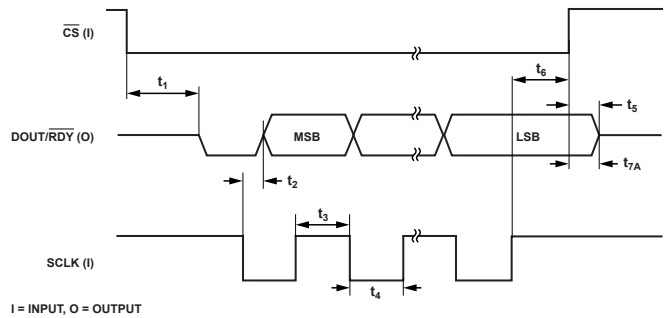

Figure 4. Read Cycle Timing Diagram ( $\overline{CS\_EN}$  Bit Set)

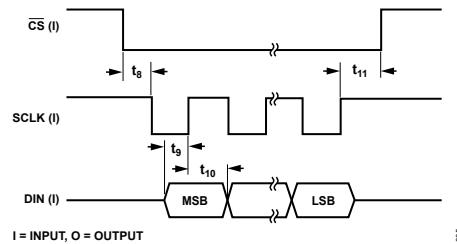

Figure 5. Write Cycle Timing Diagram

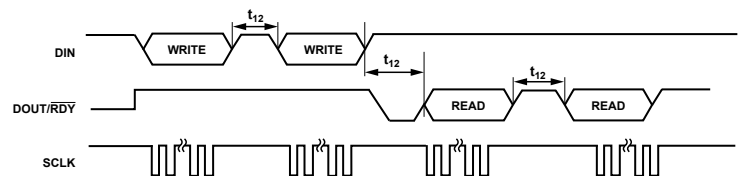
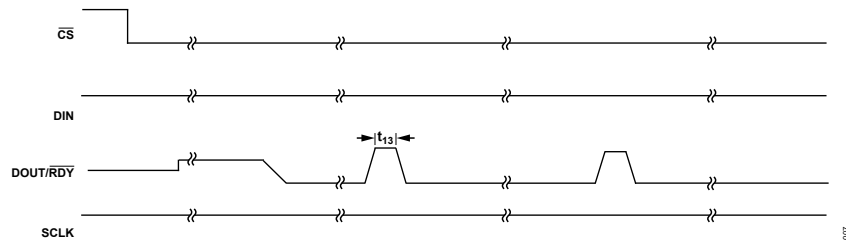
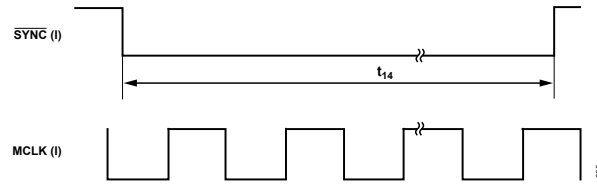

Figure 6. Delay Between Consecutive Serial Operations

**SPECIFICATIONS**



**Figure 7. DOUT/RDY High Time when DOUT/RDY is Initially Low and the Next Conversion is Available**



**Figure 8. SYNC Pulse Width**

## ABSOLUTE MAXIMUM RATINGS

$T_A = 25^\circ\text{C}$ , unless otherwise noted.

**Table 4. Absolute Maximum Ratings**

Parameter	Rating
$AV_{DD}$ to $AV_{SS}$	-0.3 V to +3.96 V
$IOV_{DD}$ to DGND	-0.3 V to +3.96 V
$IOV_{DD}$ to $AV_{SS}$	-0.3 V to +5.94 V
$AV_{SS}$ to DGND	-1.98 V to +0.3 V
Analog Input Voltage to $AV_{SS}$	-0.3 V to $AV_{DD} + 0.3$ V
Reference Input Voltage to $AV_{SS}$	-0.3 V to $AV_{DD} + 0.3$ V
Digital Input Voltage to DGND	-0.3 V to $IOV_{DD} + 0.3$ V
Digital Output Voltage to DGND	-0.3 V to $IOV_{DD} + 0.3$ V
AINx/Digital Input Current	10 mA
Operating Temperature Range	$-40^\circ\text{C}$ to $+125^\circ\text{C}$
Storage Temperature Range	$-65^\circ\text{C}$ to $+150^\circ\text{C}$
Maximum Junction Temperature	$150^\circ\text{C}$
Lead Temperature, Soldering	
Reflow	$260^\circ\text{C}$
ESD Ratings	
Human Body Model (HBM)	4 kV
Field-Induced Charged Device Model (FICDM)	1250 V
Machine Model	400 V

Stresses at or above those listed under Absolute Maximum Ratings may cause permanent damage to the product. This is a stress rating only; functional operation of the product at these or any other conditions above those indicated in the operational section of this specification is not implied. Operation beyond the maximum operating conditions for extended periods may affect product reliability.

## THERMAL RESISTANCE

Thermal performance is directly linked to the printed circuit board (PCB) design and operating environment. Careful attention to PCB thermal design is required. Thermal resistance values specified in Table 5 are calculated based on JEDEC specifications and must be used in compliance with JESD51-12. The worst-case junction temperature is reported. The values in Table 5 are calculated based on the standard JEDEC 2S2P thermal test board in a natural convection test environment. Refer to the JEDEC JESD51 series.

**Table 5. Thermal Resistance**

Package Type	$\theta_{JA}$	$\theta_{JB}$	$\theta_{JC\_TOP}$	Unit
32-Lead LFCSP	40.6	12	17.2	$^\circ\text{C/W}$

$\theta_{JA}$  is the natural convection, junction-to-ambient thermal resistance measured in a one cubic foot sealed enclosure.

$\theta_{JB}$  is the junction-to-board thermal resistance.

$\theta_{JC\_TOP}$  is the top junction-to-case thermal resistance.

## ESD CAUTION



**ESD (electrostatic discharge) sensitive device.** Charged devices and circuit boards can discharge without detection. Although this product features patented or proprietary protection circuitry, damage may occur on devices subjected to high energy ESD. Therefore, proper ESD precautions should be taken to avoid performance degradation or loss of functionality.

## PIN CONFIGURATION AND FUNCTION DESCRIPTIONS

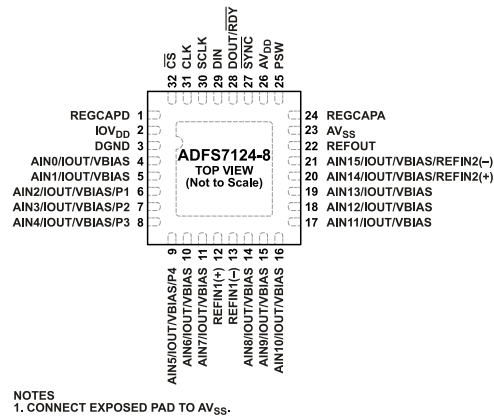

Figure 9. Pin Configuration

Table 6. Pin Function Descriptions

Pin No.	Mnemonic	Description
1	REGCAPD	Digital LDO Regulator Output. Decouple this pin to DGND with a 0.1 $\mu$ F capacitor.
2	IOV <sub>DD</sub>	Serial Interface Supply Voltage, 1.65 V to 3.6 V. IOV <sub>DD</sub> is independent of AV <sub>DD</sub> . Therefore, the serial interface can operate at 1.65 V with AV <sub>DD</sub> at 3.6 V, for example.
3	DGND	Digital Ground Reference Point.
4	AIN0/IOUT/VBIAS	Analog Input 0/Output of Internal Excitation Current Source/Bias Voltage. This input pin is configured through the configuration registers to be the positive or negative terminal of a differential or pseudodifferential input. Alternatively, the internal programmable excitation current source can be made available at this pin. Either IOUT1 or IOUT0 can be switched to this output. A bias voltage midway between the analog power supply rails can be generated at this pin.
5	AIN1/IOUT/VBIAS	Analog Input 1/Output of Internal Excitation Current Source/Bias Voltage. This input pin is configured through the configuration registers to be the positive or negative terminal of a differential or pseudodifferential input. Alternatively, the internal programmable excitation current source can be made available at this pin. Either IOUT0 or IOUT1 can be switched to this output. A bias voltage midway between the analog power supply rails can be generated at this pin.
6	AIN2/IOUT/VBIAS/P1	Analog Input 2/Output of Internal Excitation Current Source/Bias Voltage/General-Purpose Output 1. This input pin is configured through the configuration registers to be the positive or negative terminal of a differential or pseudodifferential input. Alternatively, the internal programmable excitation current source can be made available at this pin. Either IOUT0 or IOUT1 can be switched to this output. A bias voltage midway between the analog power supply rails can be generated at this pin. This pin can also be configured as a general-purpose output bit, referenced between AV <sub>SS</sub> and AV <sub>DD</sub> .
7	AIN3/IOUT/VBIAS/P2	Analog Input 3/Output of Internal Excitation Current Source/Bias Voltage/General-Purpose Output 2. This input pin is configured through the configuration registers to be the positive or negative terminal of a differential or pseudodifferential input. Alternatively, the internal programmable excitation current source can be made available at this pin. Either IOUT0 or IOUT1 can be switched to this output. A bias voltage midway between the analog power supply rails can be generated at this pin. This pin can also be configured as a general-purpose output bit, referenced between AV <sub>SS</sub> and AV <sub>DD</sub> .
8	AIN4/IOUT/VBIAS/P3	Analog Input 4/Output of Internal Excitation Current Source/Bias Voltage/General-Purpose Output 3. This input pin is configured through the configuration registers to be the positive or negative terminal of a differential or pseudodifferential input. Alternatively, the internal programmable excitation current source can be made available at this pin. Either IOUT0 or IOUT1 can be switched to this output. A bias voltage midway between the analog power supply rails can be generated at this pin. This pin can also be configured as a general-purpose output bit, referenced between AV <sub>SS</sub> and AV <sub>DD</sub> .
9	AIN5/IOUT/VBIAS/P4	Analog Input 5/Output of Internal Excitation Current Source/Bias Voltage/General-Purpose Output 4. This input pin is configured through the configuration registers to be the positive or negative terminal of a differential or pseudodifferential input. Alternatively, the internal programmable excitation current source can be made available at this pin. Either IOUT0 or IOUT1 can be switched to this output. A bias voltage midway between the analog power supply rails can be generated at this pin. This pin can also be configured as a general-purpose output bit, referenced between AV <sub>SS</sub> and AV <sub>DD</sub> .
10	AIN6/IOUT/VBIAS	Analog Input 6/Output of Internal Excitation Current Source/Bias Voltage. This input pin is configured through the configuration registers to be the positive or negative terminal of a differential or pseudodifferential input. Alternatively, the internal programmable excitation current source can be made available at this pin. Either IOUT0 or IOUT1 can be switched to this output. A bias voltage midway between the analog power supply rails can be generated at this pin.
11	AIN7/IOUT/VBIAS	Analog Input 7/Output of Internal Excitation Current Source/Bias Voltage. This input pin is configured through the configuration registers to be the positive or negative terminal of a differential or pseudodifferential input. Alternatively, the internal programmable

## PIN CONFIGURATION AND FUNCTION DESCRIPTIONS

Table 6. Pin Function Descriptions (Continued)

Pin No.	Mnemonic	Description
12	REFIN1(+)	excitation current source can be made available at this pin. Either IOUT0 or IOUT1 can be switched to this output. A bias voltage midway between the analog power supply rails can be generated at this pin. Positive Reference Input. An external reference can be applied between REFIN1(+) and REFIN1(-). REFIN1(+) can be anywhere between $AV_{DD}$ and $AV_{SS} + 0.5$ V. The nominal reference voltage (REFIN1(+) – REFIN1(-)) is 2.5 V, but the device functions with a reference from 0.5 V to $AV_{DD}$ .
13	REFIN1(-)	Negative Reference Input. This reference input can be anywhere between $AV_{SS}$ and $AV_{DD} - 0.5$ V.
14	AIN8/IOUT/VBIAS	Analog Input 8/Output of Internal Excitation Current Source/Bias Voltage. This input pin is configured through the configuration registers to be the positive or negative terminal of a differential or pseudodifferential input. Alternatively, the internal programmable excitation current source can be made available at this pin. Either IOUT0 or IOUT1 can be switched to this output. A bias voltage midway between the analog power supply rails can be generated at this pin.
15	AIN9/IOUT/VBIAS	Analog Input 9/Output of Internal Excitation Current Source/Bias Voltage. This input pin is configured through the configuration registers to be the positive or negative terminal of a differential or pseudodifferential input. Alternatively, the internal programmable excitation current source can be made available at this pin. Either IOUT0 or IOUT1 can be switched to this output. A bias voltage midway between the analog power supply rails can be generated at this pin.
16	AIN10/IOUT/VBIAS	Analog Input 10/Output of Internal Excitation Current Source/Bias Voltage. This input pin is configured through the configuration registers to be the positive or negative terminal of a differential or pseudodifferential input. Alternatively, the internal programmable excitation current source can be made available at this pin. Either IOUT0 or IOUT1 can be switched to this output. A bias voltage midway between the analog power supply rails can be generated at this pin.
17	AIN11/IOUT/VBIAS	Analog Input 11/Output of Internal Excitation Current Source/Bias Voltage. This input pin is configured through the configuration registers to be the positive or negative terminal of a differential or pseudodifferential input. Alternatively, the internal programmable excitation current source can be made available at this pin. Either IOUT0 or IOUT1 can be switched to this output. A bias voltage midway between the analog power supply rails can be generated at this pin.
18	AIN12/IOUT/VBIAS	Analog Input 12/Output of Internal Excitation Current Source/Bias Voltage. This input pin is configured through the configuration registers to be the positive or negative terminal of a differential or pseudodifferential input. Alternatively, the internal programmable excitation current source can be made available at this pin. Either IOUT0 or IOUT1 can be switched to this output. A bias voltage midway between the analog power supply rails can be generated at this pin.
19	AIN13/IOUT/VBIAS	Analog Input 13/Output of Internal Excitation Current Source/Bias Voltage. This input pin is configured through the configuration registers to be the positive or negative terminal of a differential or pseudodifferential input. Alternatively, the internal programmable excitation current source can be made available at this pin. Either IOUT0 or IOUT1 can be switched to this output. A bias voltage midway between the analog power supply rails can be generated at this pin.
20	AIN14/IOUT/VBIAS/ REFIN2(+)	Analog Input 14/Output of Internal Excitation Current Source/Bias Voltage/Positive Reference Input. This input pin is configured through the configuration registers to be the positive or negative terminal of a differential or pseudodifferential input. Alternatively, the internal programmable excitation current source can be made available at this pin. Either IOUT0 or IOUT1 can be switched to this output. A bias voltage midway between the analog power supply rails can be generated at this pin. This pin also functions as a positive reference input for REFIN2(±). REFIN2(+) can be anywhere between $AV_{DD}$ and $AV_{SS} + 0.5$ V. The nominal reference voltage (REFIN2(+) to REFIN2(-)) is 2.5 V, but the device functions with a reference from 0.5 V to $AV_{DD}$ .
21	AIN15/IOUT/VBIAS/ REFIN2(-)	Analog Input 15/Output of Internal Excitation Current Source/Bias Voltage/Negative Reference Input. This input pin is configured through the configuration registers to be the positive or negative terminal of a differential or pseudodifferential input. Alternatively, the internal programmable excitation current source can be made available at this pin. Either IOUT0 or IOUT1 can be switched to this output. A bias voltage midway between the analog power supply rails can be generated at this pin. This pin also functions as the negative reference input for REFIN2(±). This reference input can be anywhere between $AV_{SS}$ and $AV_{DD} - 0.5$ V.
22	REFOUT	Internal Reference Output. The buffered output of the internal 2.5 V voltage reference is available on this pin.
23	$AV_{SS}$	Analog Supply Voltage. The voltage on $AV_{DD}$ is referenced to $AV_{SS}$ . The differential between $AV_{DD}$ and $AV_{SS}$ must be between 2.7 V and 3.6 V in mid or low power mode and between 2.9 V and 3.6 V in full power mode. $AV_{SS}$ can be taken below 0 V to provide a dual power supply to the ADFS7124-8. For example, $AV_{SS}$ can be tied to -1.8 V and $AV_{DD}$ can be tied to +1.8 V, providing a ±1.8 V supply to the ADC.
24	REGCAPA	Analog LDO Regulator Output. Decouple this pin to $AV_{SS}$ with a 0.1 μF capacitor.
25	PSW	Low-Side Power Switch to $AV_{SS}$ .
26	$AV_{DD}$	Analog Supply Voltage, Relative to $AV_{SS}$ .
27	$\overline{\text{SYNC}}$	Synchronization Input. This pin is a logic input that allows synchronization of the digital filters and analog modulators when using a number of ADFS7124-8 devices. When $\overline{\text{SYNC}}$ is low, the nodes of the digital filter, the filter control logic, and the calibration control logic are reset, and the analog modulator is held in a reset state. $\overline{\text{SYNC}}$ does not affect the digital interface but does reset RDY to a high state if it is low.

## PIN CONFIGURATION AND FUNCTION DESCRIPTIONS

Table 6. Pin Function Descriptions (Continued)

Pin No.	Mnemonic	Description
28	DOUT/RDY	Serial Data Output/Data Ready Output. DOUT/RDY functions as a serial data output pin to access the output shift register of the ADC. The output shift register can contain data from any of the on-chip data or control registers. In addition, DOUT/RDY operates as a data ready pin, going low to indicate the completion of a conversion. If the data is not read after the conversion, the pin goes high before the next update occurs. The DOUT/RDY falling edge can also be used as an interrupt to a processor, indicating that valid data is available. With an external serial clock, the data can be read using the DOUT/RDY pin. When $\overline{CS}$ is low, the data/control word information is placed on the DOUT/RDY pin on the SCLK falling edge and is valid on the SCLK rising edge.
29	DIN	Serial Data Input to the Input Shift Register on the ADC. Data in the input shift register is transferred to the control registers within the ADC, with the register selection bits of the communications register identifying the appropriate register.
30	SCLK	Serial Clock Input. This serial clock input is for data transfers to and from the ADC. The SCLK pin has a Schmitt-triggered input, making the interface suitable for opto-isolated applications. The serial clock can be continuous with all data transmitted in a continuous train of pulses. Alternatively, it can be a noncontinuous clock with the information being transmitted to or from the ADC in smaller batches of data.
31	CLK	Clock Input/Clock Output. The internal clock can be made available at this pin. Alternatively, the internal clock can be disabled, and the ADC can be driven by an external clock. This allows several ADCs to be driven from a common clock, allowing simultaneous conversions to be performed.
32	$\overline{CS}$	Chip Select Input. This is an active low logic input that selects the ADC. Use $\overline{CS}$ to select the ADC in systems with more than one device on the serial bus or as a frame synchronization signal in communicating with the device. $\overline{CS}$ can be hardwired low if the serial peripheral interface (SPI) diagnostics are unused, allowing the ADC to operate in 3-wire mode with SCLK, DIN, and DOUT interfacing with the device.
	EP	Exposed Pad. Connect the exposed pad to $AV_{SS}$ .



TYPICAL PERFORMANCE CHARACTERISTICS

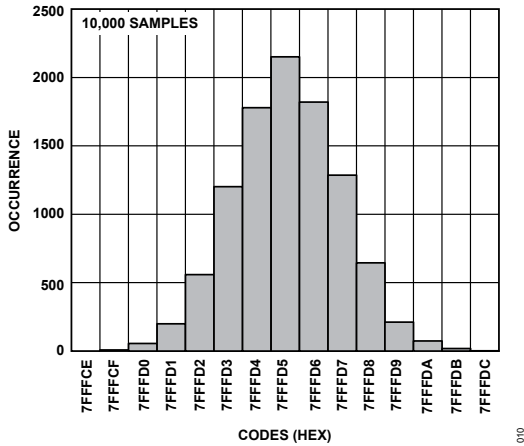

Figure 10. Noise Histogram Plot (Full Power Mode, Post Filter, Output Data Rate = 25 SPS, Gain = 1)

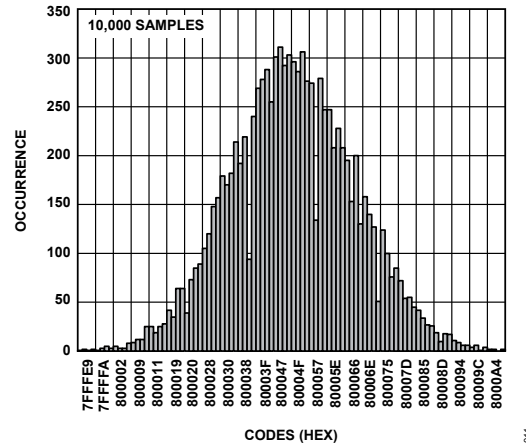

Figure 13. Noise Histogram Plot (Full Power Mode, Post Filter, Output Data Rate = 25 SPS, Gain = 128)

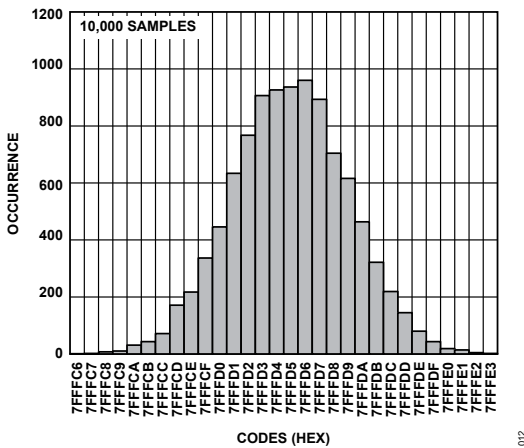

Figure 11. Noise Histogram Plot (Mid Power Mode, Post Filter, Output Data Rate = 25 SPS, Gain = 1)

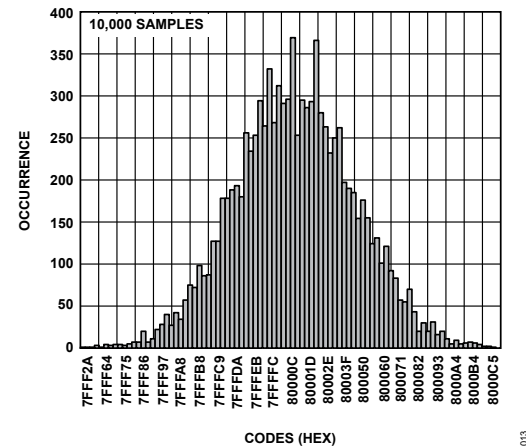

Figure 14. Noise Histogram Plot (Mid Power Mode, Post Filter, Output Data Rate = 25 SPS, Gain = 128)

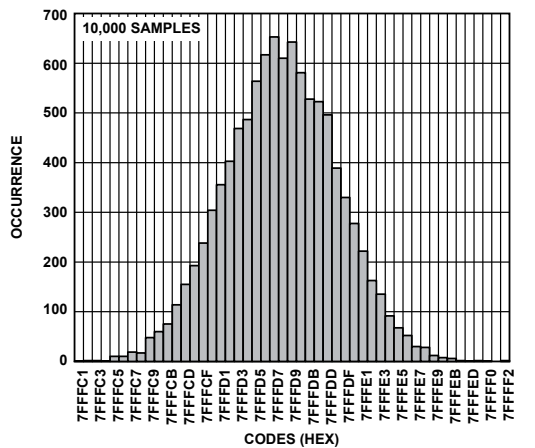

Figure 12. Noise Histogram Plot (Low Power Mode, Post Filter, Output Data Rate = 25 SPS, Gain = 1)

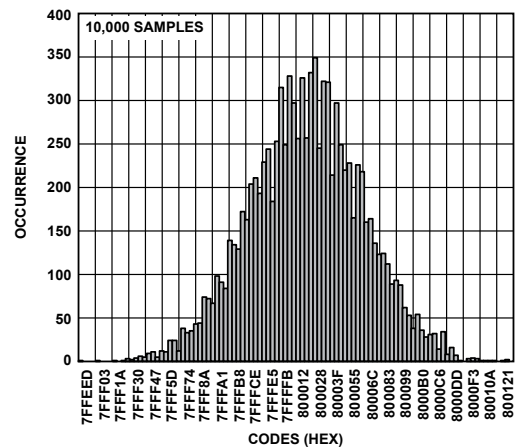

Figure 15. Noise Histogram Plot (Low Power Mode, Post Filter, Output Data Rate = 25 SPS, Gain = 128)

TYPICAL PERFORMANCE CHARACTERISTICS

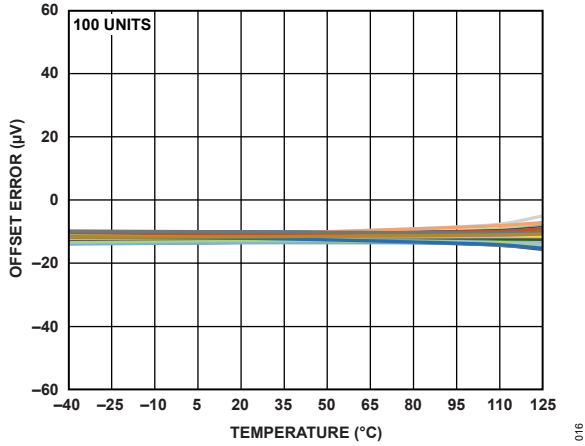

Figure 16. Input Referred Offset Error vs. Temperature (Gain = 8, Full Power Mode)

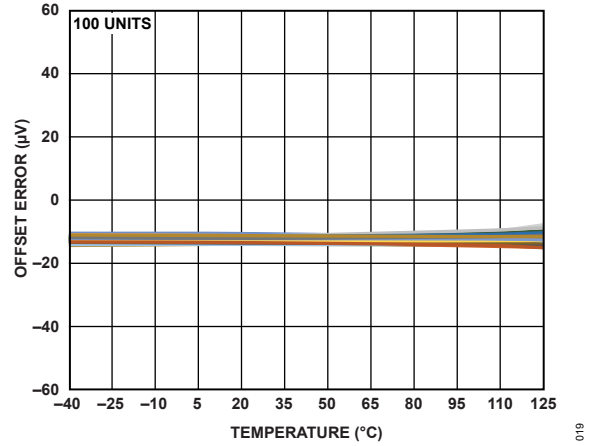

Figure 19. Input Referred Offset Error vs. Temperature (Gain = 16, Full Power Mode)

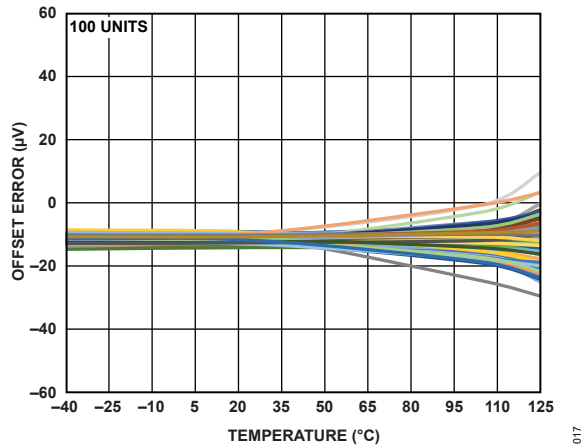

Figure 17. Input Referred Offset Error vs. Temperature (Gain = 8, Mid Power Mode)

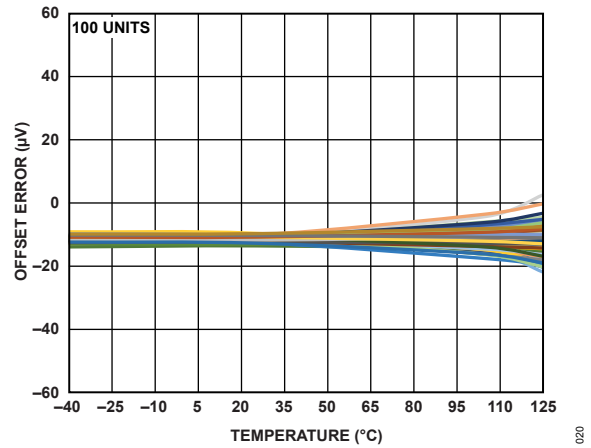

Figure 20. Input Referred Offset Error vs. Temperature (Gain = 16, Mid Power Mode)

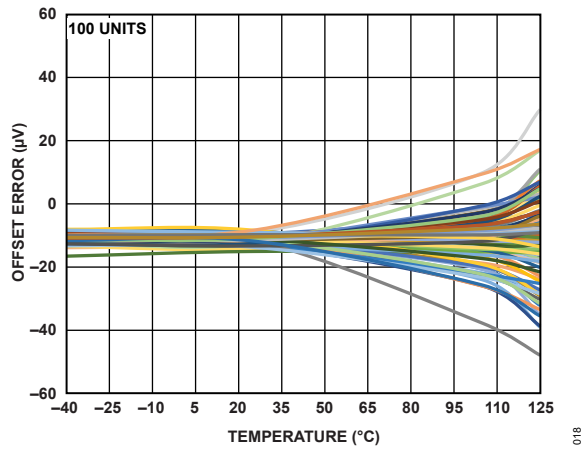

Figure 18. Input Referred Offset Error vs. Temperature (Gain = 8, Low Power Mode)

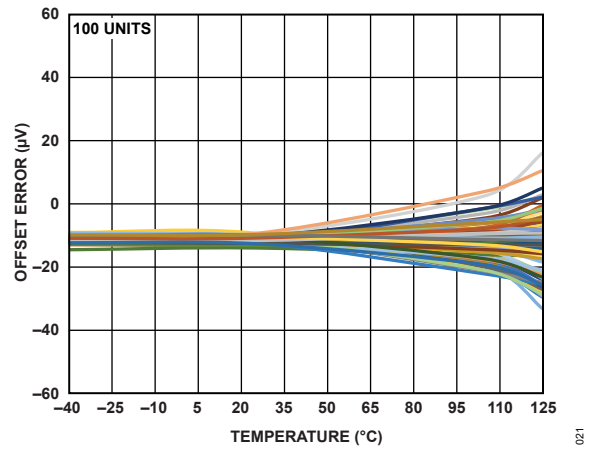

Figure 21. Input Referred Offset Error vs. Temperature (Gain = 16, Low Power Mode)

TYPICAL PERFORMANCE CHARACTERISTICS

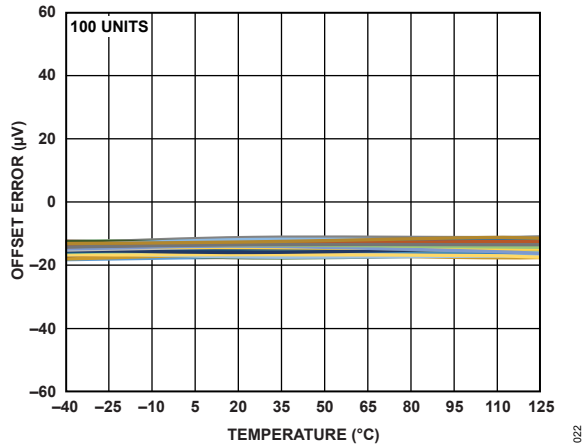

Figure 22. Input Referred Offset Error vs. Temperature (Gain = 1, Analog Input Buffers Enabled)

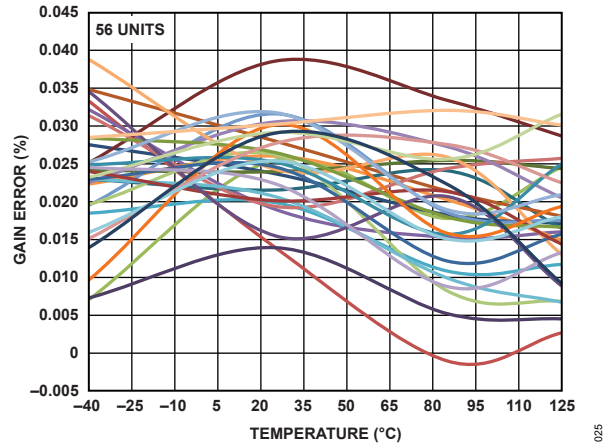

Figure 25. Input Referred Gain Error vs. Temperature (Gain = 16)

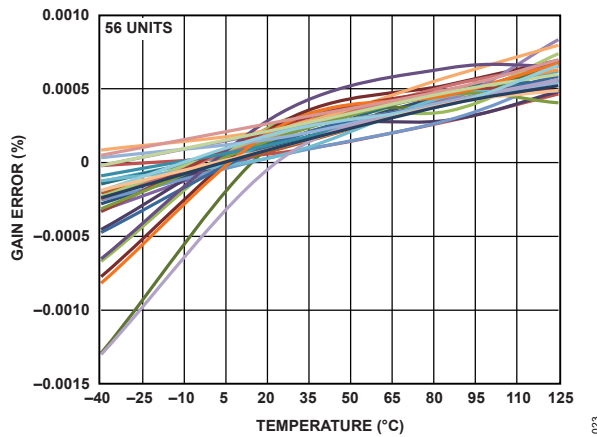

Figure 23. Input Referred Gain Error vs. Temperature (Gain = 1)

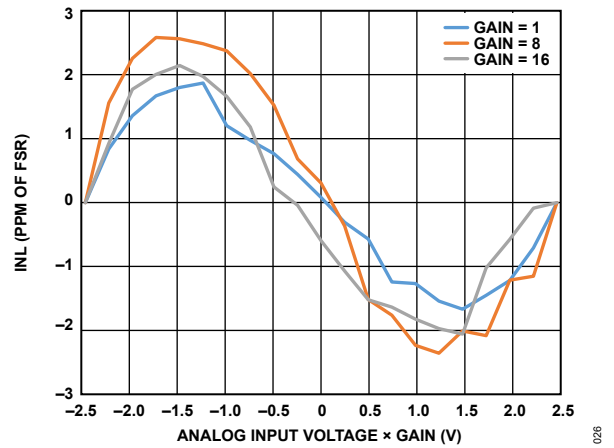

Figure 26. INL vs. Differential Input Signal (Analog Input × Gain), ODR = 50 SPS, External 2.5 V Reference

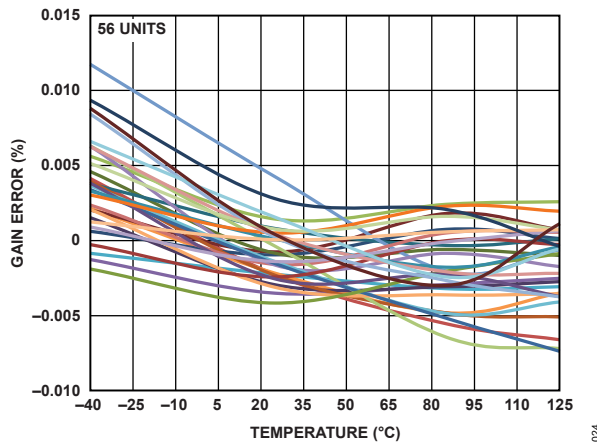

Figure 24. Input Referred Gain Error vs. Temperature (Gain = 8)

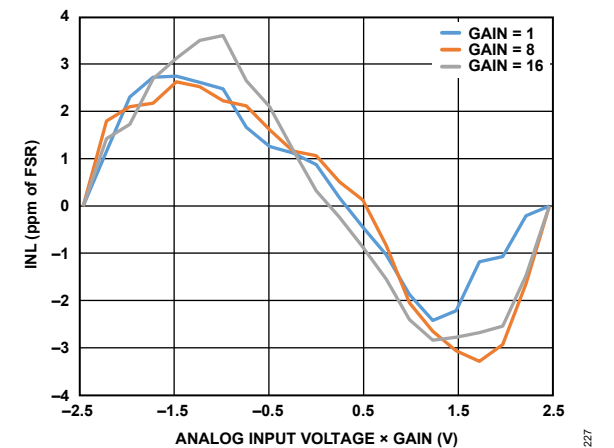

Figure 27. INL vs. Differential Input Signal (Analog Input × Gain), ODR = 50 SPS, Internal Reference

TYPICAL PERFORMANCE CHARACTERISTICS

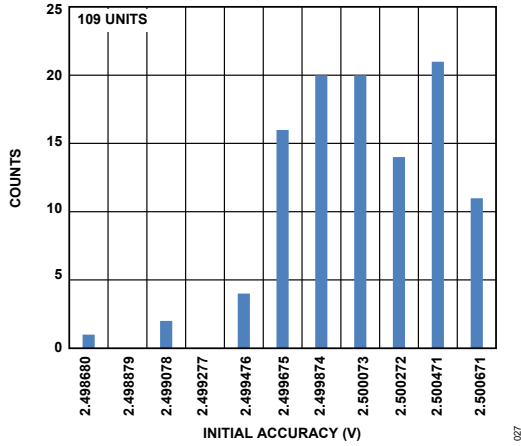

Figure 28. Internal Reference Voltage Histogram

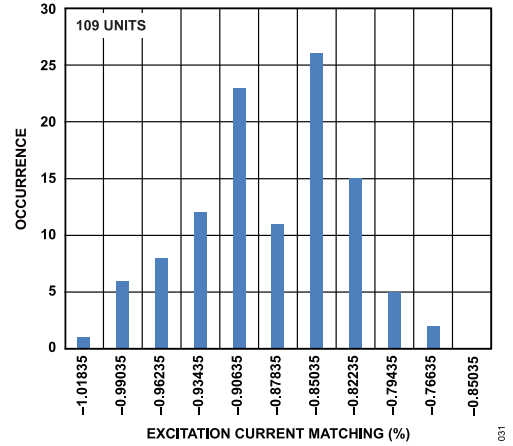

Figure 31. IOUTx Current Initial Matching Histogram (500 µA)

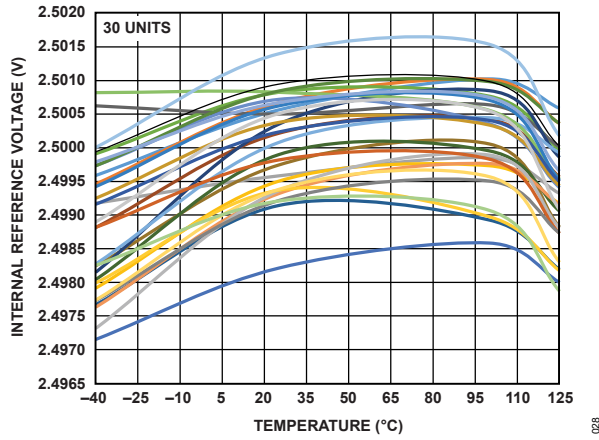

Figure 29. Internal Reference Voltage vs. Temperature

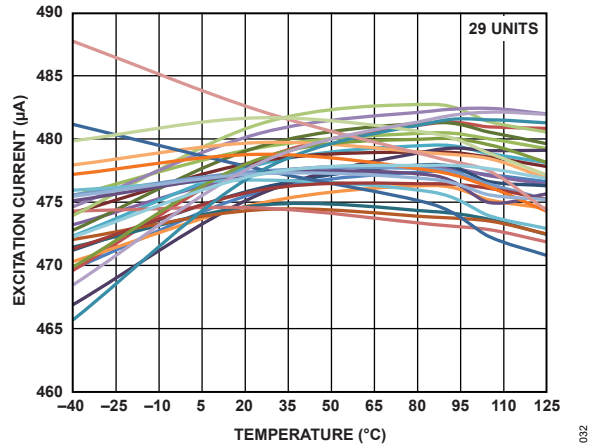

Figure 32. Excitation Current Drift (500 µA)

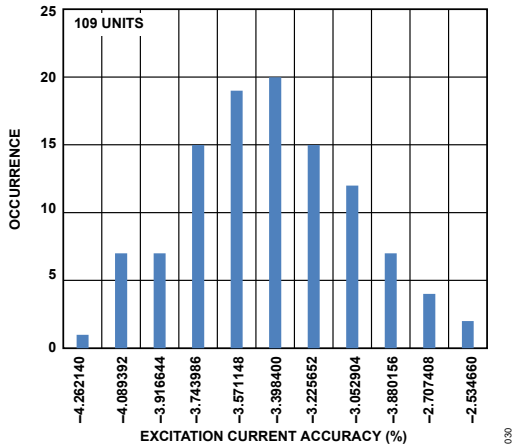

Figure 30. IOUTx Current Initial Accuracy Histogram (500 µA)

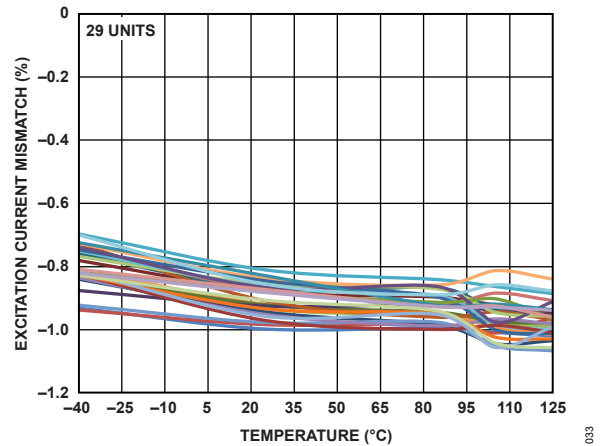

Figure 33. Excitation Current Drift Matching (500 µA)

TYPICAL PERFORMANCE CHARACTERISTICS

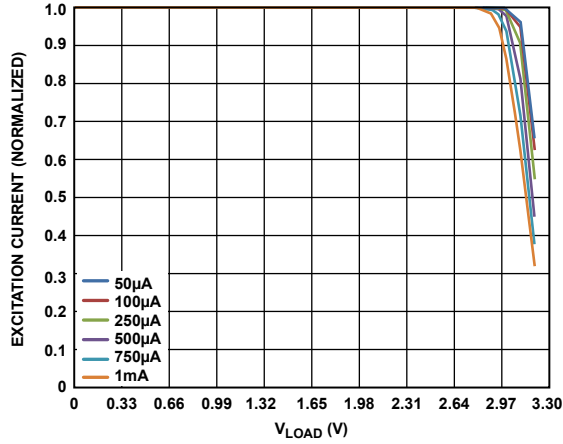

Figure 34. Output Compliance ( $AV_{DD} = 3.3V$ )

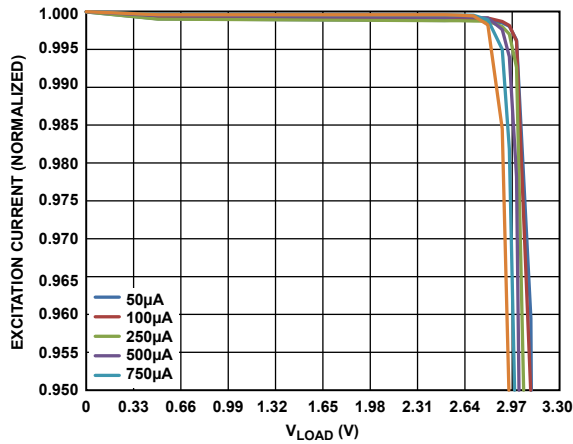

Figure 35. Output Compliance ( $AV_{DD} = 3.3V$ )

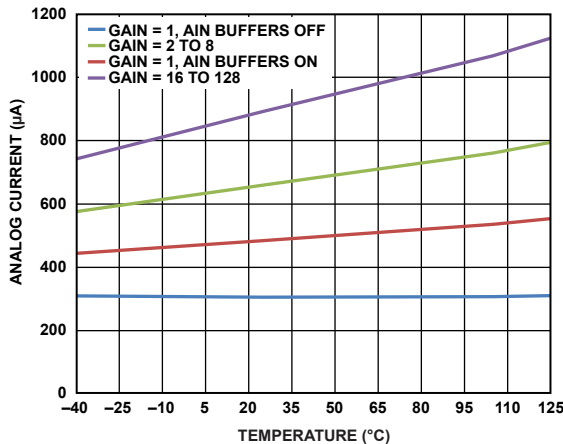

Figure 36. Analog Current vs. Temperature (Full Power Mode)

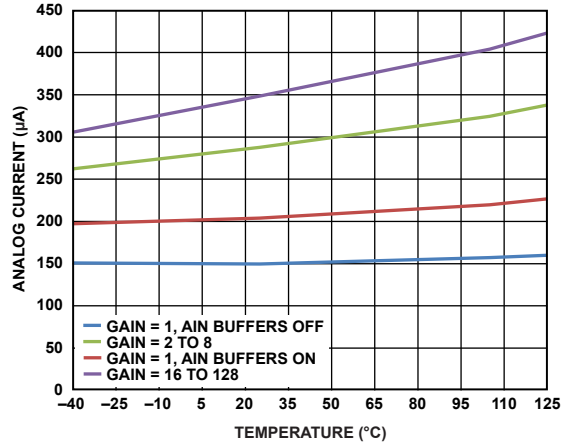

Figure 37. Analog Current vs. Temperature (Mid Power Mode)

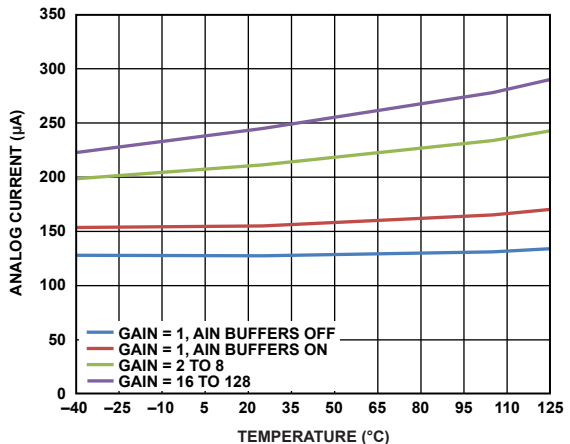

Figure 38. Analog Current vs. Temperature (Low Power Mode)

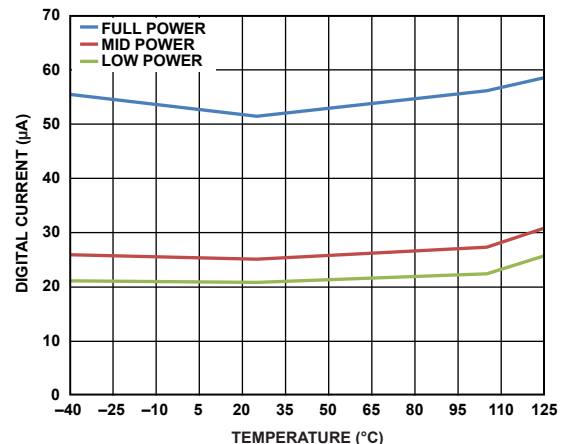

Figure 39. Digital Current vs. Temperature

TYPICAL PERFORMANCE CHARACTERISTICS

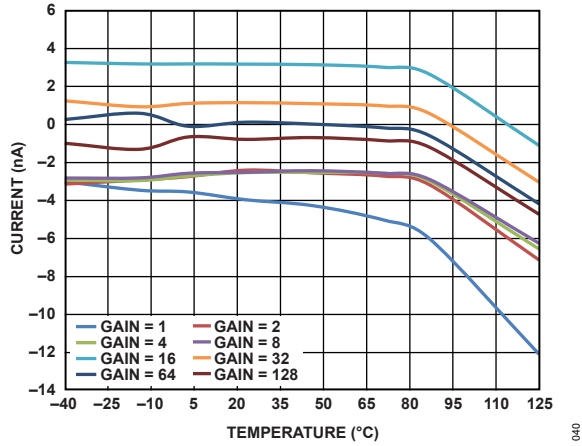

Figure 40. Absolute Analog Input Current vs. Temperature (Full Power Mode)

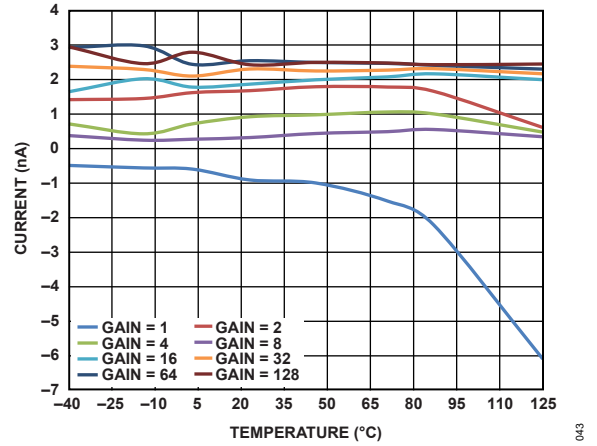

Figure 43. Differential Analog Input Current vs. Temperature (Full Power Mode)

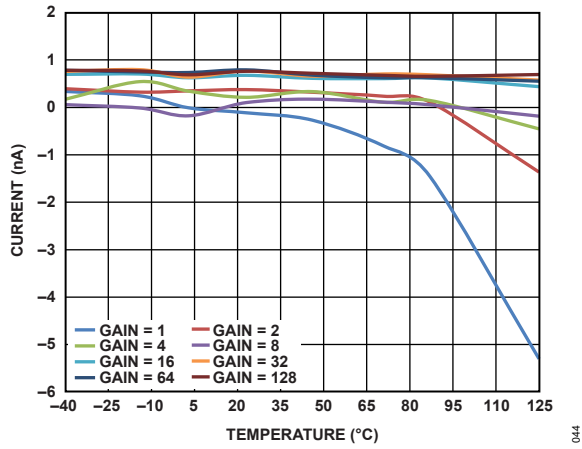

Figure 41. Absolute Analog Input Current vs. Temperature (Mid Power Mode)

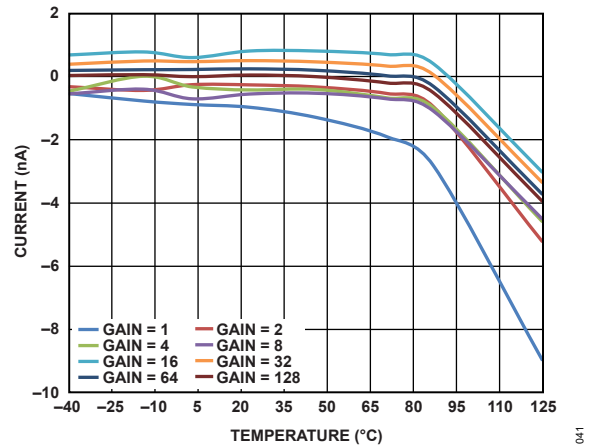

Figure 44. Differential Analog Input Current vs. Temperature (Mid Power Mode)

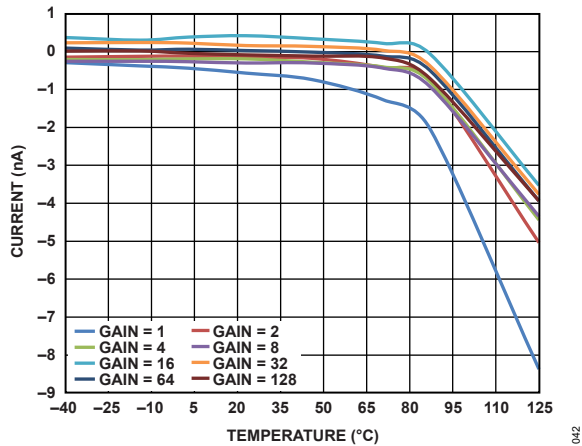

Figure 42. Absolute Analog Input Current vs. Temperature (Low Power Mode)

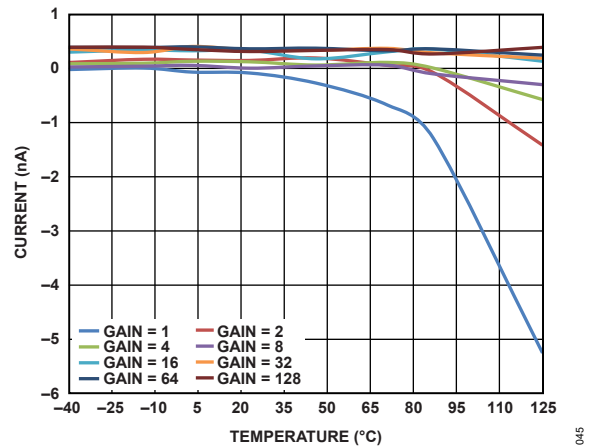

Figure 45. Differential Analog Input Current vs. Temperature (Low Power Mode)

TYPICAL PERFORMANCE CHARACTERISTICS

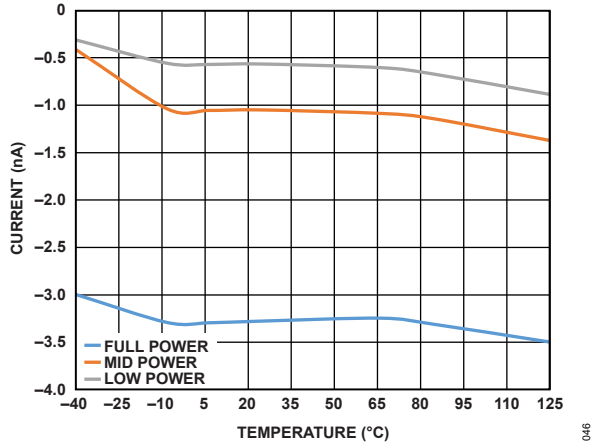

Figure 46. Reference Input Current vs. Temperature (Reference Buffers Enabled)

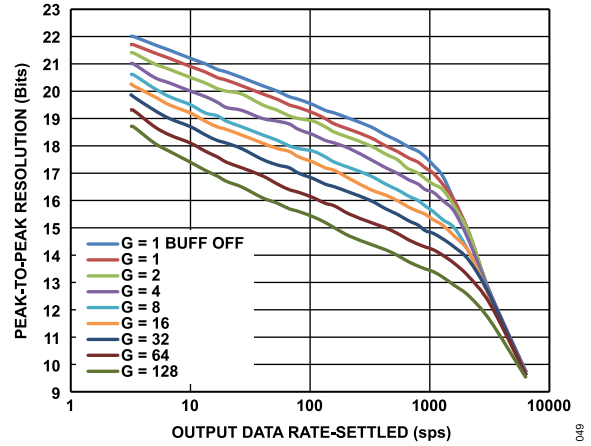

Figure 49. Peak-to-Peak Resolution vs. Output Data Rate (Settled),  $Sinc^3$  Filter (Full Power Mode)

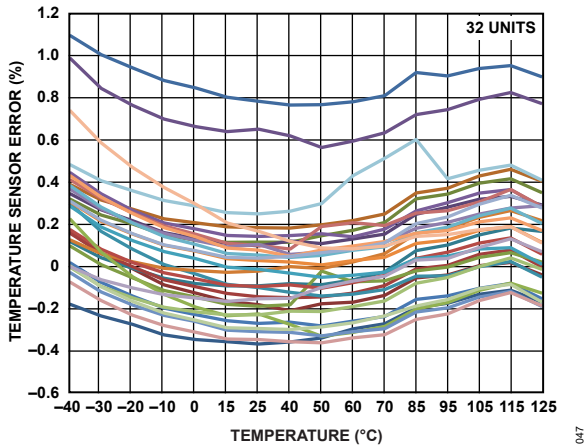

Figure 47. Temperature Sensor Accuracy

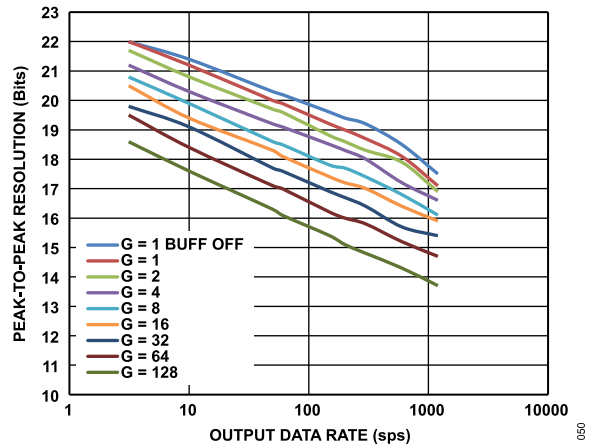

Figure 50. Peak-to-Peak Resolution vs. Output Data Rate,  $Sinc^4 + Sinc^1$  Filter (Full Power Mode)

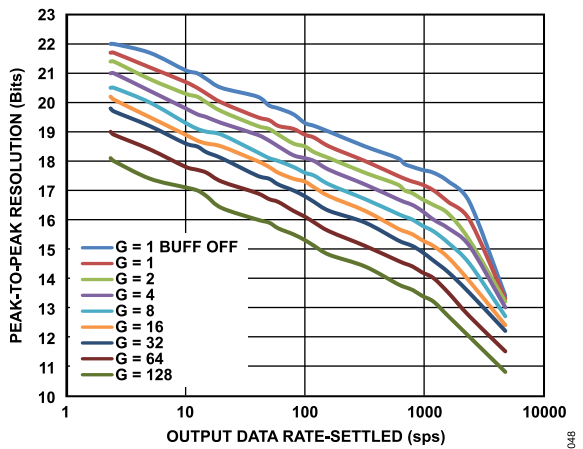

Figure 48. Peak-to-Peak Resolution vs. Output Data Rate (Settled),  $Sinc^4$  Filter (Full Power Mode)

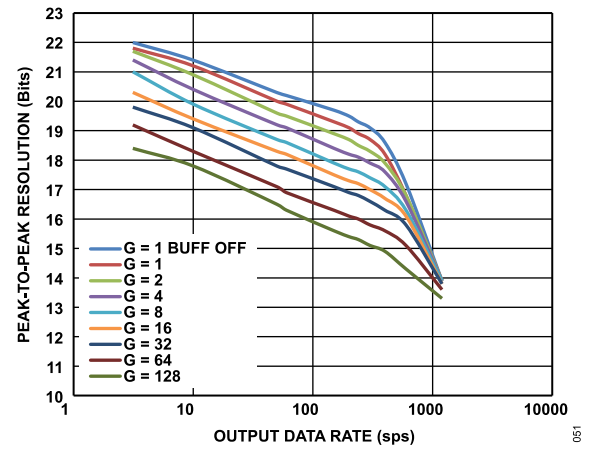

Figure 51. Peak-to-Peak Resolution vs. Output Data Rate,  $Sinc^3 + Sinc^1$  Filter (Full Power Mode)

TYPICAL PERFORMANCE CHARACTERISTICS

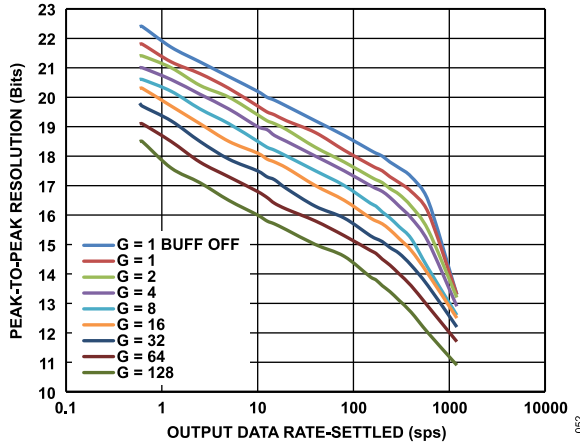

Figure 52. Peak-to-Peak Resolution vs. Output Data Rate (Settled),  $Sinc^4$  Filter (Mid Power Mode)

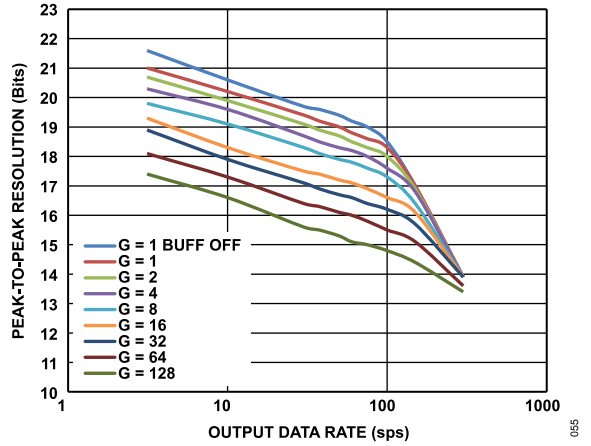

Figure 55. Peak-to-Peak Resolution vs. Output Data Rate,  $Sinc^3 + Sinc^1$  Filter (Mid Power Mode)

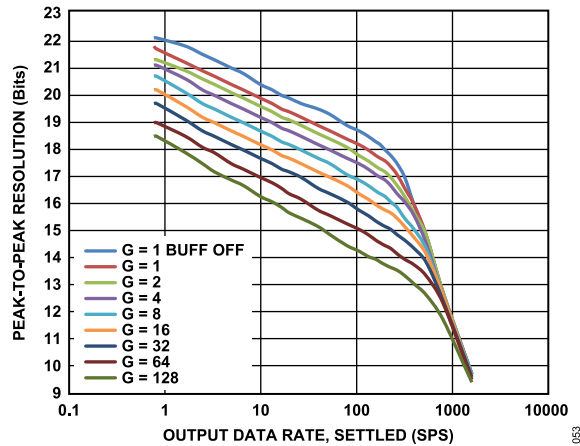

Figure 53. Peak-to-Peak Resolution vs. Output Data Rate (Settled),  $Sinc^3$  Filter (Mid Power Mode)

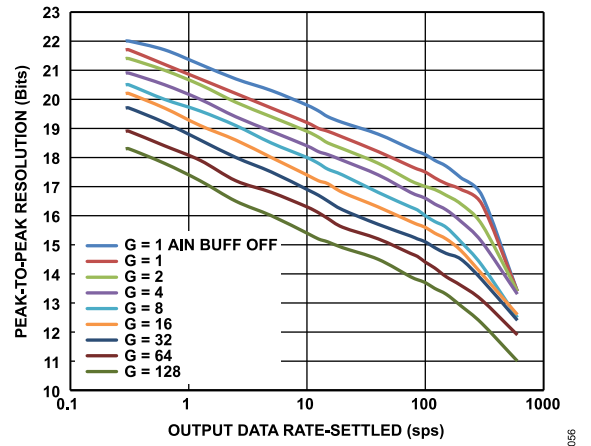

Figure 56. Peak-to-Peak Resolution vs. Output Data Rate (Settled),  $Sinc^4$  Filter (Low Power Mode)

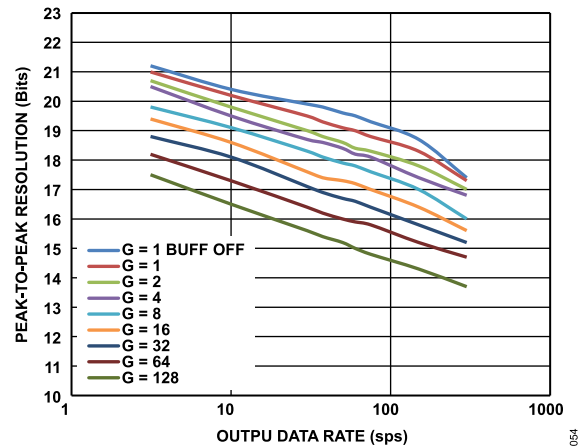

Figure 54. Peak-to-Peak Resolution vs. Output Data Rate,  $Sinc^4 + Sinc^1$  Filter (Mid Power Mode)

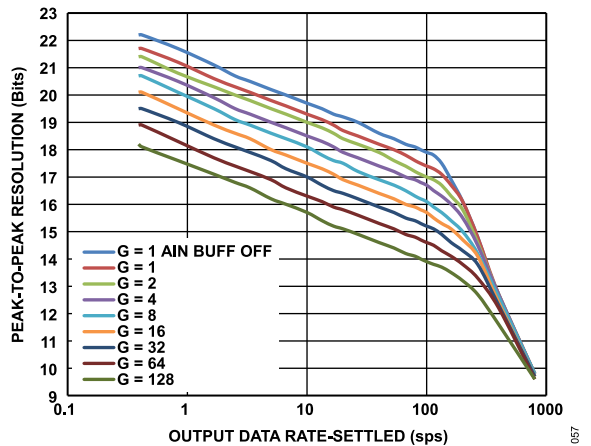

Figure 57. Peak-to-Peak Resolution vs. Output Data Rate (Settled),  $Sinc^3$  Filter (Low Power Mode)



TYPICAL PERFORMANCE CHARACTERISTICS

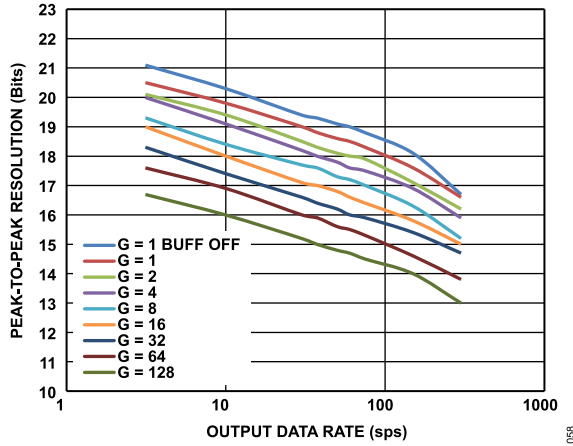

Figure 58. Peak-to-Peak Resolution vs. Output Data Rate,  $Sinc^4 + Sinc^1$  Filter (Low Power Mode)

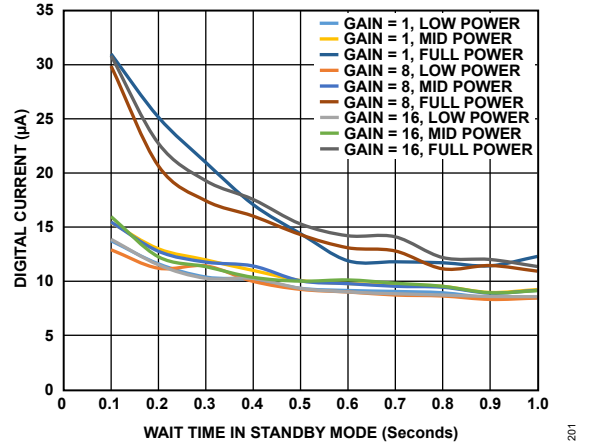

Figure 61. Digital Current vs. Wait Time in Standby Mode, ADC in Single Conversion Mode (50 SPS)

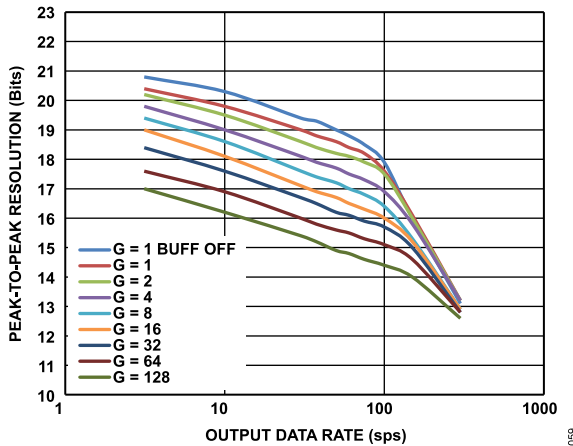

Figure 59. Peak-to-Peak Resolution vs. Output Data Rate,  $Sinc^3 + Sinc^1$  Filter (Low Power Mode)

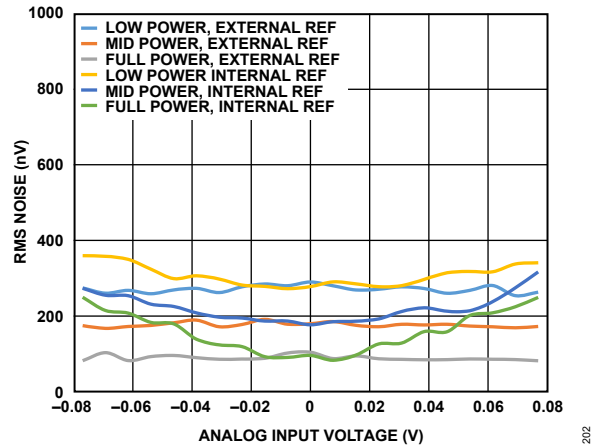

Figure 62. RMS Noise vs. Analog Input Voltage for the Internal Reference and External Reference (Gain = 32, 50 SPS)

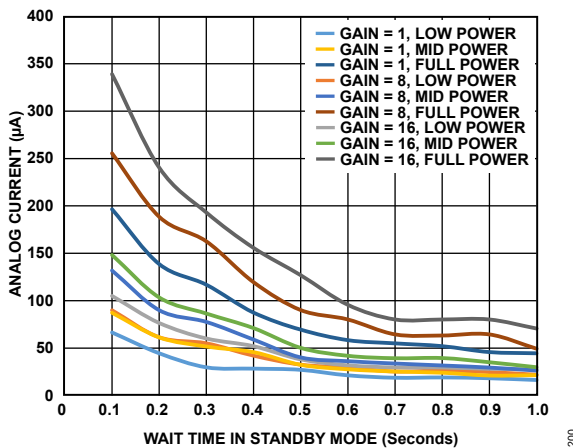

Figure 60. Analog Current vs. Wait Time in Standby Mode, ADC in Single Conversion Mode (50 SPS)

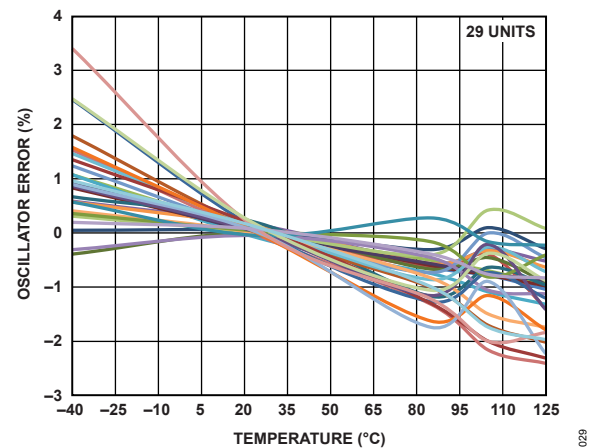

Figure 63. Internal Oscillator Error vs. Temperature

## TERMINOLOGY

### AINP

AINP refers to the positive analog input.

### AINM

AINM refers to the negative analog input.

### Integral Nonlinearity (INL)

INL is the maximum deviation of any code from a straight line passing through the endpoints of the transfer function. The endpoints of the transfer function are zero scale (not to be confused with bipolar zero), a point 0.5 LSB below the first code transition (000 ... 000 to 000 ... 001), and full scale, a point 0.5 LSB above the last code transition (111 ... 110 to 111 ... 111). The error is expressed in ppm of the full-scale range.

### Gain Error

Gain error is the deviation of the last code transition (111 ... 110 to 111 ... 111) from the ideal AINP voltage ( $A_{INM} + V_{REF}/gain - 3/2$  LSBs). Gain error applies to both unipolar and bipolar analog input ranges.

Gain error is a measure of the span error of the ADC. It includes full-scale errors but not zero-scale errors. For unipolar input ranges, it is defined as full-scale error minus unipolar offset error; whereas for bipolar input ranges it is defined as full-scale error minus bipolar zero error.

### Offset Error

Offset error is the deviation of the first code transition from the ideal AINP voltage ( $A_{INM} + 0.5$  LSB) when operating in the unipolar mode.

In bipolar mode, offset error is the deviation of the midscale transition (0111 ... 111 to 1000 ... 000) from the ideal AINP voltage ( $A_{INM} - 0.5$  LSB).

### Offset Calibration Range

In the system calibration modes, the ADFS7124-8 calibrates offset with respect to the analog input. The offset calibration range specification defines the range of voltages that the ADFS7124-8 can accept and still calibrate offset accurately.

### Full-Scale Calibration Range

The full-scale calibration range is the range of voltages that the ADFS7124-8 can accept in the system calibration mode and still calibrate full scale correctly.

### Input Span

In system calibration schemes, two voltages applied in sequence to the ADFS7124-8 analog input define the analog input range. The input span specification defines the minimum and maximum input voltages from zero to full scale that the ADFS7124-8 can accept and still calibrate gain accurately.

## RMS NOISE AND RESOLUTION

Table 7 through Table 36 show the RMS noise, peak-to-peak noise, effective resolution, and noise-free (peak-to-peak) resolution of the ADFS7124-8 for various output data rates, gain settings, and filters. The numbers given are for the bipolar input range with an external 2.5 V reference. These numbers are typical and are generated with a differential input voltage of 0 V when the ADC is continuously converting on a single channel. It is important to note that the effective resolution is calculated using the RMS noise, whereas the

peak-to-peak resolution (shown in parentheses) is calculated based on peak-to-peak noise (shown in parentheses). The peak-to-peak resolution represents the resolution for which there is no code flicker.

$$\text{Effective Resolution} = \text{Log}_2 (\text{Input Range}/\text{RMS Noise})$$

$$\text{Peak-to-Peak Resolution} = \text{Log}_2 (\text{Input Range}/\text{Peak-to-Peak Noise})$$

## FULL POWER MODE

### Sinc<sup>4</sup>

Table 7. RMS Noise (Peak-to-Peak Noise) vs. Gain and Output Data Rate ( $\mu\text{V}$ ), Full Power Mode

Filter Word (Dec.)	Output Data Rate (SPS)	Output Data Rate (Zero Latency Mode) (SPS)	$f_{3\text{dB}}$ (Hz)	Gain								
				Gain = 1	Gain = 2	Gain = 4	Gain = 8	Gain = 16	Gain = 32	Gain = 64	Gain = 128	
2047	9.4	2.34	2.16	0.24 (1.5)	0.15 (0.89)	0.091 (0.6)	0.071 (0.41)	0.045 (0.26)	0.031 (0.17)	0.025 (0.15)	0.023 (0.14)	
1920	10	2.5	2.3	0.23 (1.5)	0.14 (0.89)	0.094 (0.6)	0.076 (0.42)	0.048 (0.27)	0.03 (0.19)	0.025 (0.16)	0.025 (0.15)	
960	20	5	4.6	0.31 (2.1)	0.22 (1.3)	0.13 (0.89)	0.1 (0.6)	0.069 (0.41)	0.044 (0.26)	0.035 (0.22)	0.034 (0.22)	
480	40	10	9.2	0.42 (3)	0.3 (2.1)	0.19 (1.4)	0.14 (0.97)	0.09 (0.63)	0.063 (0.39)	0.053 (0.34)	0.043 (0.27)	
384	50	12.5	11.5	0.48 (3.2)	0.33 (2.1)	0.2 (1.3)	0.16 (1.1)	0.1 (0.75)	0.068 (0.43)	0.059 (0.42)	0.048 (0.28)	
320	60	15	13.8	0.51 (3.3)	0.35 (2.4)	0.23 (1.3)	0.17 (1.2)	0.11 (0.78)	0.077 (0.5)	0.064 (0.41)	0.056 (0.35)	
240	80	20	18.4	0.6 (4.8)	0.41 (3)	0.28 (1.8)	0.19 (1.3)	0.13 (0.86)	0.09 (0.54)	0.072 (0.48)	0.063 (0.45)	
120	160	40	36.8	0.86 (6.9)	0.55 (4.1)	0.37 (2.5)	0.29 (2)	0.2 (1.2)	0.13 (0.84)	0.11 (0.7)	0.098 (0.6)	
60	320	80	73.6	1.2 (8.9)	0.76 (6.1)	0.53 (4.1)	0.4 (2.7)	0.26 (1.8)	0.18 (1.2)	0.15 (0.95)	0.14 (0.86)	
30	640	160	147.2	1.7 (13)	1.1 (8.8)	0.74 (5.7)	0.57 (4.1)	0.38 (2.9)	0.26 (2)	0.22 (1.6)	0.19 (1.4)	
15	1280	320	294.4	2.4 (19)	1.6 (13)	1.1 (8.4)	0.82 (6)	0.55 (4)	0.38 (2.5)	0.3 (2.3)	0.26 (1.8)	
8	2400	600	552	3.3 (25)	2.3 (16)	1.5 (12)	1.2 (8)	0.76 (6)	0.53 (4)	0.43 (3.2)	0.37 (2.7)	
4	4800	1200	1104	4.9 (38)	3.4 (25)	2.4 (20)	2 (13)	1.3 (9.1)	0.83 (6.4)	0.68 (4.8)	0.58 (4.3)	
2	9600	2400	2208	8.8 (76)	6.8 (61)	4.9 (34)	4.3 (27)	2.6 (21)	1.7 (13)	1.3 (12)	1.2 (9.4)	
1	19,200	4800	4416	72 (500)	38 (270)	21 (150)	13 (95)	7.5 (57)	4.4 (33)	3.3 (26)	2.8 (23)	

Table 8. Effective Resolution (Peak-to-Peak Resolution) vs. Gain and Output Data Rate (Bits), Full Power Mode

Filter Word (Dec.)	Output Data Rate (SPS)	Output Data Rate (Zero Latency Mode) (SPS)	Gain								
			Gain = 1	Gain = 2	Gain = 4	Gain = 8	Gain = 16	Gain = 32	Gain = 64	Gain = 128	
2047	9.4	2.34	24 (21.7)	24 (21.4)	23.7 (21)	23.1 (20.5)	22.7 (20.2)	22.3 (19.8)	21.6 (19)	20.7 (18.1)	
1920	10	2.5	24 (21.7)	24 (21.4)	23.7 (21)	23 (20.5)	22.6 (20.1)	22.3 (19.7)	21.6 (19)	20.7 (18.1)	
960	20	5	23.9 (21.2)	23.5 (20.8)	23.2 (20.4)	22.5 (20)	22.1 (19.5)	21.8 (19.2)	21.1 (18.4)	20.1 (17.4)	
480	40	10	23.5 (20.7)	23 (20.3)	22.6 (19.8)	22.1 (19.3)	21.7 (18.9)	21.2 (18.6)	20.5 (17.8)	19.8 (17.1)	
384	50	12.5	23.3 (20.5)	22.9 (20.2)	22.5 (19.6)	21.9 (19.1)	21.5 (18.7)	21.1 (18.5)	20.4 (17.7)	19.6 (17)	
320	60	15	23.2 (20.3)	22.8 (20)	22.4 (19.5)	21.8 (19)	21.4 (18.6)	21 (18.3)	20.2 (17.6)	19.4 (16.6)	
240	80	20	23 (20)	22.6 (19.7)	22.1 (19.3)	21.6 (18.9)	21.2 (18.5)	20.7 (18.1)	20 (17.3)	19.2 (16.4)	
120	160	40	22.5 (19.5)	22.1 (19.2)	21.7 (18.9)	21 (18.3)	20.6 (18)	20.1 (17.5)	19.5 (16.9)	18.6 (16)	
60	320	80	22 (19.1)	21.6 (18.6)	21.2 (18.2)	20.6 (17.8)	20.2 (17.4)	19.7 (17)	19 (16.3)	18.1 (15.5)	
30	640	160	21.5 (18.5)	21.1 (18.1)	20.7 (17.7)	20.1 (17.2)	19.7 (16.8)	19.2 (16.3)	18.5 (15.6)	17.6 (14.8)	
15	1280	320	21 (18)	20.5 (17.6)	20.2 (17.2)	19.5 (16.7)	19.1 (16.3)	18.7 (15.9)	18 (15.1)	17.2 (14.4)	
8	2400	600	20.5 (17.5)	20.1 (17.2)	19.7 (16.7)	19 (16.2)	18.6 (15.7)	18.2 (15.3)	17.5 (14.6)	16.7 (13.8)	
4	4800	1200	20 (17)	19.5 (16.5)	19 (16)	18.3 (15.6)	17.9 (15.1)	17.5 (14.6)	16.8 (14)	16 (13.2)	
2	9600	2400	19.1 (16)	18.5 (15.3)	18 (15.1)	17.2 (14.5)	16.9 (13.9)	16.5 (13.5)	15.9 (12.7)	15 (12)	
1	19,200	4800	16.1 (13.3)	16 (13.2)	15.9 (13)	15.5 (12.7)	15.4 (12.4)	15.1 (12.2)	14.6 (11.5)	13.8 (10.8)	

## RMS NOISE AND RESOLUTION

Sinc<sup>3</sup>Table 9. RMS Noise (Peak-to-Peak Noise) vs. Gain and Output Data Rate ( $\mu\text{V}$ ), Full Power Mode

Filter Word (Dec.)	Output Data Rate (SPS)	Output Data Rate (Zero Latency Mode) (SPS)	$f_{3dB}$ (Hz)	Gain								
				Gain = 1	Gain = 2	Gain = 4	Gain = 8	Gain = 16	Gain = 32	Gain = 64	Gain = 128	
2047	9.4	3.13	2.56	0.23 (1.5)	0.15 (0.89)	0.096 (0.58)	0.07 (0.38)	0.046 (0.25)	0.033 (0.16)	0.023 (0.11)	0.017 (0.09)	
1920	10	3.33	2.72	0.24 (1.5)	0.15 (0.89)	0.096 (0.6)	0.07 (0.4)	0.05 (0.26)	0.034 (0.17)	0.023 (0.12)	0.018 (0.09)	
1280	15	5	5.44	0.31 (1.8)	0.18 (1.2)	0.12 (0.82)	0.09 (0.55)	0.059 (0.35)	0.041 (0.24)	0.033 (0.18)	0.027 (0.14)	
640	30	10	8.16	0.4 (2.6)	0.26 (1.6)	0.17 (1.2)	0.11 (0.82)	0.088 (0.52)	0.055 (0.36)	0.048 (0.27)	0.039 (0.22)	
384	50	16.67	13.6	0.53 (3.3)	0.3 (2.2)	0.2 (1.6)	0.17 (1.1)	0.1 (0.75)	0.075 (0.51)	0.062 (0.39)	0.056 (0.33)	
320	60	20	16.32	0.55 (3.6)	0.37 (2.4)	0.24 (1.8)	0.19 (1.3)	0.12 (0.8)	0.084 (0.54)	0.068 (0.44)	0.06 (0.37)	
160	120	40	32.64	0.78 (5.1)	0.53 (3.4)	0.35 (2.3)	0.26 (1.8)	0.17 (1.1)	0.12 (0.85)	0.1 (0.66)	0.097 (0.55)	
80	240	80	65.28	1.1 (7)	0.73 (4.9)	0.49 (3.2)	0.37 (2.6)	0.25 (1.6)	0.17 (1.2)	0.14 (1)	0.12 (0.78)	
40	480	160	130.56	1.5 (11)	1.1 (6.8)	0.67 (4.5)	0.52 (3.7)	0.34 (2.2)	0.25 (1.7)	0.19 (1.4)	0.17 (1.2)	
20	960	320	261.12	2.3 (16)	1.5 (9.8)	0.99 (6.6)	0.75 (5.1)	0.53 (3.5)	0.35 (2.4)	0.28 (2.1)	0.25 (1.8)	
10	1920	640	522.24	3.2 (26)	2.2 (16)	1.5 (11)	1.1 (8.5)	0.73 (5.5)	0.49 (3.9)	0.4 (3.2)	0.35 (2.7)	
6	3200	1066.67	870.4	4.9 (38)	3.2 (24)	2.1 (15)	1.6 (12)	1 (7.7)	0.68 (5.6)	0.56 (4.2)	0.48 (3.6)	
3	6400	2133.33	1740.8	25 (170)	13 (89)	7.1 (54)	4.3 (35)	2.4 (18)	1.5 (11)	1.1 (8.4)	0.9 (6.7)	
2	9600	3200	2611.2	110 (820)	54 (390)	28 (210)	14 (110)	7.4 (57)	3.9 (27)	2.3 (17)	1.7 (13)	
1	19,200	6400	5222.4	890 (6500)	430 (3000)	220 (1500)	110 (790)	55 (390)	28 (190)	14 (100)	7.6 (56)	

Table 10. Effective Resolution (Peak-to-Peak Resolution) vs. Gain and Output Data Rate, Full Power Mode

Filter Word (Dec.)	Output Data Rate (SPS)	Output Data Rate (Zero Latency Mode) (SPS)	Gain								
			Gain = 1	Gain = 2	Gain = 4	Gain = 8	Gain = 16	Gain = 32	Gain = 64	Gain = 128	
2047	9.4	3.13	24 (21.7)	24 (21.4)	23.6 (21)	23.1 (20.6)	22.7 (20.3)	22.2 (19.9)	21.7 (19.3)	21 (18.7)	
1920	10	3.33	24 (21.7)	24 (21.4)	23.6 (21)	23.1 (20.6)	22.6 (20.2)	22.2 (19.8)	21.7 (19.3)	21 (18.7)	
1280	15	5	24 (21.4)	23.7 (21)	23.2 (20.5)	22.7 (20.1)	22.3 (19.8)	21.9 (19.3)	21.2 (18.7)	20.5 (18.1)	
640	30	10	23.6 (20.9)	23.2 (20.5)	22.8 (20)	22.2 (19.5)	21.8 (19.2)	21.4 (18.7)	20.6 (18.1)	19.9 (17.4)	
384	50	16.67	23.2 (20.5)	22.8 (20.1)	22.4 (19.6)	21.8 (19.1)	21.4 (18.7)	21 (18.2)	20.3 (17.6)	19.4 (16.9)	
320	60	20	23.1 (20.4)	22.7 (20)	22.3 (19.4)	21.7 (18.9)	21.3 (18.6)	20.8 (18.1)	20.1 (17.4)	19.3 (16.7)	
160	120	40	22.6 (19.9)	22.2 (19.5)	21.8 (19)	21.2 (18.4)	20.8 (18.1)	20.3 (17.5)	19.6 (16.9)	18.7 (16.1)	
80	240	80	22.1 (19.4)	21.7 (19)	21.3 (18.6)	20.7 (17.9)	20.3 (17.6)	19.8 (17)	19.1 (16.3)	18.3 (15.6)	
40	480	160	21.6 (18.8)	21.2 (18.5)	20.8 (18.1)	20.2 (17.4)	19.8 (17.1)	19.3 (16.5)	18.6 (15.8)	17.8 (15)	
20	960	320	21.1 (18.3)	20.7 (18)	20.3 (17.5)	19.7 (16.9)	19.2 (16.4)	18.8 (16)	18.1 (15.2)	17.3 (14.4)	
10	1920	640	20.6 (17.6)	20.1 (17.2)	19.7 (16.8)	19.1 (16.2)	18.7 (15.8)	18.3 (15.3)	17.6 (14.6)	16.8 (13.8)	
6	3200	1066.67	19.9 (17)	19.6 (16.6)	19.2 (16.3)	18.6 (15.6)	18.2 (15.3)	17.8 (14.8)	17.1 (14.2)	16.3 (13.4)	
3	6400	2133.33	17.6 (14.8)	17.6 (14.8)	17.4 (14.5)	17.2 (14.1)	17 (14.1)	16.7 (13.8)	16.3 (13.2)	15.4 (12.5)	
2	9600	3200	15.5 (12.6)	15.5 (12.6)	15.4 (12.6)	15.4 (12.5)	15.4 (12.4)	15.3 (12.5)	15 (12.2)	14.5 (11.6)	
1	19,200	6400	12.5 (9.7)	12.5 (9.7)	12.5 (9.7)	12.5 (9.6)	12.5 (9.6)	12.4 (9.6)	12.4 (9.6)	12.3 (9.5)	

## Post Filters

Table 11. RMS Noise (Peak-to-Peak Noise) vs. Gain and Output Data Rate ( $\mu\text{V}$ ), Full Power Mode

Output Data Rate (SPS)	Gain = 1	Gain = 2	Gain = 4	Gain = 8	Gain = 16	Gain = 32	Gain = 64	Gain = 128
16.67	0.51 (3.3)	0.34 (2.1)	0.21 (1.3)	0.16 (0.97)	0.11 (0.65)	0.075 (0.41)	0.062 (0.34)	0.051 (0.3)
20	0.53 (3.3)	0.36 (2.1)	0.23 (1.3)	0.18 (1)	0.11 (0.65)	0.078 (0.45)	0.062 (0.34)	0.051 (0.3)

## RMS NOISE AND RESOLUTION

Table 11. RMS Noise (Peak-to-Peak Noise) vs. Gain and Output Data Rate ( $\mu\text{V}$ ), Full Power Mode (Continued)

Output Data Rate (SPS)	Gain = 1	Gain = 2	Gain = 4	Gain = 8	Gain = 16	Gain = 32	Gain = 64	Gain = 128
25	0.57 (3.6)	0.37 (2.2)	0.25 (1.6)	0.18 (1.2)	0.12 (0.75)	0.082 (0.47)	0.062 (0.38)	0.055 (0.31)
27.27	0.6 (3.9)	0.38 (2.2)	0.26 (1.6)	0.19 (1.2)	0.13 (0.82)	0.084 (0.55)	0.072 (0.44)	0.063 (0.43)

Table 12. Effective Resolution (Peak-to-Peak Resolution) vs. Gain and Output Data Rate (Bits), Full Power Mode

Output Data Rate (SPS)	Gain = 1	Gain = 2	Gain = 4	Gain = 8	Gain = 16	Gain = 32	Gain = 64	Gain = 128
16.67	23.2 (20.5)	22.8 (20.2)	22.5 (19.9)	21.9 (19.3)	21.5 (18.9)	21 (18.5)	20.3 (17.8)	19.5 (17)
20	23.2 (20.5)	22.7 (20.2)	22.3 (19.9)	21.7 (19.2)	21.5 (18.9)	20.9 (18.4)	20.3 (17.8)	19.5 (17)
25	23.1 (20.4)	22.7 (20.1)	22.2 (19.6)	21.7 (19)	21.3 (18.7)	20.9 (18.3)	20.3 (17.7)	19.5 (17)
27.27	23 (20.3)	22.6 (20.1)	22.2 (19.5)	21.7 (19)	21.2 (18.5)	20.8 (18.1)	20.1 (17.4)	19.2 (16.5)

Fast Settling Filter ( $\text{Sinc}^4 + \text{Sinc}^1$ )Table 13. RMS Noise (Peak-to-Peak Noise) vs. Gain and Output Data Rate ( $\mu\text{V}$ ), Full Power Mode (Average by 16)

Filter Word (Dec.)	Output Data Rate (SPS)	Gain = 1	Gain = 2	Gain = 4	Gain = 8	Gain = 16	Gain = 32	Gain = 64	Gain = 128
384	3.125	0.19 (1.2)	0.11 (0.75)	0.077 (0.52)	0.063 (0.34)	0.036 (0.21)	0.027 (0.17)	0.021 (0.11)	0.019 (0.098)
120	10	0.32 (2.1)	0.2 (1.3)	0.13 (0.97)	0.1 (0.63)	0.067 (0.46)	0.045 (0.28)	0.039 (0.23)	0.031 (0.2)
24	50	0.69 (4.6)	0.44 (3)	0.29 (2.1)	0.23 (1.6)	0.14 (0.99)	0.1 (0.72)	0.081 (0.54)	0.07 (0.49)
20	60	0.71 (5.1)	0.49 (3.1)	0.3 (2.2)	0.25 (1.7)	0.16 (1.1)	0.11 (0.78)	0.09 (0.6)	0.082 (0.57)
2	600	2.4 (18)	1.6 (10)	1.1 (8.3)	0.87 (5.5)	0.56 (3.5)	0.47 (2.9)	0.33 (2.1)	0.3 (2)
1	1200	4.8 (35)	3 (20)	1.9 (12)	1.4 (8.8)	0.89 (5.2)	0.57 (3.7)	0.49 (3)	0.44 (3)

Table 14. Effective Resolution (Peak-to-Peak Resolution) vs. Gain and Output Data Rate (Bits), Full Power Mode (Average by 16)

Filter Word (Dec.)	Output Data Rate (SPS)	Gain = 1	Gain = 2	Gain = 4	Gain = 8	Gain = 16	Gain = 32	Gain = 64	Gain = 128
384	3.125	24 (22)	24 (21.7)	23.9 (21.2)	23.3 (20.8)	23 (20.5)	22.5 (19.8)	21.8 (19.5)	21 (18.6)
120	10	23.9 (21.2)	23.6 (20.8)	23.3 (20.3)	22.5 (19.9)	22.2 (19.4)	21.9 (19.1)	20.9 (18.4)	20.2 (17.6)
24	50	22.8 (20)	22.4 (19.7)	22.1 (19.2)	21.4 (18.6)	21.1 (18.3)	20.5 (17.7)	19.9 (17.1)	19.1 (16.3)
20	60	22.7 (19.9)	22.3 (19.6)	22 (19.1)	21.2 (18.5)	20.9 (18.1)	20.4 (17.6)	19.7 (17)	18.9 (16.1)
2	600	21 (18.1)	20.6 (17.9)	20.2 (17.2)	19.5 (16.8)	19.1 (16.4)	18.4 (15.7)	17.8 (15.2)	17 (14.3)
1	1200	20 (17.1)	19.7 (16.9)	19.3 (16.6)	18.8 (16.1)	18.4 (15.9)	18.1 (15.4)	17.3 (14.7)	16.5 (13.7)

Fast Settling Filter ( $\text{Sinc}^3 + \text{Sinc}^1$ )Table 15. RMS Noise (Peak-to-Peak Noise) vs. Gain and Output Data Rate ( $\mu\text{V}$ ), Full Power Mode (Average by 16)

Filter Word (Dec.)	Output Data Rate (SPS)	Gain = 1	Gain = 2	Gain = 4	Gain = 8	Gain = 16	Gain = 32	Gain = 64	Gain = 128
384	3.125	0.22 (1.4)	0.13 (0.75)	0.081 (0.44)	0.048 (0.3)	0.039 (0.24)	0.026 (0.18)	0.025 (0.13)	0.019 (0.11)
120	10	0.31 (2.1)	0.21 (1.3)	0.13 (0.89)	0.1 (0.63)	0.068 (0.47)	0.047 (0.28)	0.036 (0.25)	0.033 (0.17)
24	50	0.7 (4.8)	0.46 (3.1)	0.29 (2.1)	0.22 (1.5)	0.14 (0.95)	0.098 (0.67)	0.079 (0.56)	0.071 (0.44)
20	60	0.77 (5.2)	0.5 (3.4)	0.31 (2.3)	0.24 (1.6)	0.17 (1)	0.11 (0.73)	0.09 (0.66)	0.077 (0.48)
2	600	6.1 (46)	3.2 (23)	1.8 (12)	1.1 (7.5)	0.65 (4.3)	0.4 (2.7)	0.31 (2.2)	0.27 (2)
1	1200	44 (320)	22 (160)	11 (80)	5.7 (40)	2.9 (22)	1.5 (11)	0.83 (6.2)	0.54 (4)

Table 16. Effective Resolution (Peak-to-Peak Resolution) vs. Gain and Output Data Rate (Bits), Full Power Mode (Average by 16)

Filter Word (Dec.)	Output Data Rate (SPS)	Gain = 1	Gain = 2	Gain = 4	Gain = 8	Gain = 16	Gain = 32	Gain = 64	Gain = 128
384	3.125	24 (21.8)	24 (21.7)	23.9 (21.4)	23.6 (21)	22.9 (20.3)	22.5 (19.8)	21.6 (19.2)	21 (18.4)
120	10	24 (21.2)	23.5 (20.9)	23.2 (20.4)	22.6 (19.9)	22.1 (19.4)	21.7 (19.1)	21 (18.3)	20.2 (17.8)

## RMS NOISE AND RESOLUTION

Table 16. Effective Resolution (Peak-to-Peak Resolution) vs. Gain and Output Data Rate (Bits), Full Power Mode (Average by 16) (Continued)

Filter Word (Dec.)	Output Data Rate (SPS)	Gain							
		Gain = 1	Gain = 2	Gain = 4	Gain = 8	Gain = 16	Gain = 32	Gain = 64	Gain = 128
24	50	22.8 (20)	22.4 (19.6)	22.1 (19.2)	21.4 (18.7)	21.1 (18.3)	20.6 (17.8)	19.9 (17.1)	19.1 (16.5)
20	60	22.6 (19.9)	22.3 (19.5)	22 (19.1)	21.3 (18.6)	20.8 (18.2)	20.4 (17.7)	19.7 (16.9)	19 (16.3)
2	600	19.7 (16.8)	19.6 (16.8)	19.4 (16.6)	19.1 (16.3)	18.9 (16.1)	18.6 (15.8)	17.9 (15.1)	17.2 (14.3)
1	1200	16.8 (13.9)	16.8 (13.9)	16.8 (13.9)	16.7 (13.9)	16.7 (13.8)	16.6 (13.8)	16.5 (13.6)	16.1 (13.3)

## MID POWER MODE

Sinc<sup>4</sup>Table 17. RMS Noise (Peak-to-Peak Noise) vs. Gain and Output Data Rate ( $\mu\text{V}$ ), Mid Power Mode

Filter Word (Dec.)	Output Data Rate (SPS)	Output Data Rate (Zero Latency Mode) (SPS)	$f_{3\text{dB}}$ (Hz)	Gain							
				Gain = 1	Gain = 2	Gain = 4	Gain = 8	Gain = 16	Gain = 32	Gain = 64	Gain = 128
2047	2.34	0.586	0.52	0.22 (1.4)	0.14 (0.88)	0.095 (0.6)	0.062 (0.38)	0.048 (0.24)	0.036 (0.17)	0.024 (0.14)	0.02 (0.1)
1920	2.5	0.625	0.575	0.25 (1.4)	0.17 (0.88)	0.11 (0.6)	0.073 (0.38)	0.048 (0.24)	0.037 (0.19)	0.024 (0.14)	0.021 (0.1)
960	5	1.25	1.15	0.34 (2)	0.21 (1.2)	0.13 (0.77)	0.085 (0.52)	0.064 (0.36)	0.052 (0.25)	0.04 (0.21)	0.035 (0.2)
480	10	2.5	2.3	0.44 (2.8)	0.28 (1.8)	0.19 (1.1)	0.1 (0.82)	0.1 (0.55)	0.072 (0.41)	0.057 (0.34)	0.048 (0.28)
240	20	5	4.6	0.67 (3.8)	0.4 (2.4)	0.27 (1.6)	0.2 (1.1)	0.14 (0.85)	0.098 (0.64)	0.081 (0.47)	0.07 (0.43)
120	40	10	9.2	0.98 (6)	0.58 (3.6)	0.37 (2.3)	0.27 (1.7)	0.2 (1.1)	0.14 (0.87)	0.11 (0.74)	0.09 (0.57)
96	50	12.5	11.5	1 (7.4)	0.67 (4.2)	0.41 (2.5)	0.28 (1.9)	0.23 (1.3)	0.15 (0.95)	0.13 (0.78)	0.11 (0.7)
80	60	15	13.8	1.1 (7.2)	0.7 (4.3)	0.44 (3)	0.33 (2.1)	0.24 (1.4)	0.17 (1.1)	0.14 (0.89)	0.12 (0.75)
60	80	20	18.4	1.3 (8.4)	0.8 (5.1)	0.53 (3.4)	0.37 (2.4)	0.27 (1.6)	0.2 (1.3)	0.18 (1.1)	0.13 (0.82)
30	160	40	36.8	1.8 (11)	1.2 (7.6)	0.73 (4.6)	0.54 (3.4)	0.39 (2.4)	0.28 (1.9)	0.23 (1.4)	0.19 (1.2)
15	320	80	73.6	2.6 (17)	1.7 (11)	1 (6.6)	0.79 (4.7)	0.58 (3.4)	0.4 (2.5)	0.33 (2)	0.26 (1.5)
8	600	150	138	3.7 (23)	2.3 (15)	1.5 (9.6)	1.2 (7.2)	0.84 (5)	0.56 (4)	0.46 (2.8)	0.4 (2.6)
4	1200	300	276	5.3 (36)	3.6 (24)	2.4 (16)	1.9 (13)	1.3 (8.2)	0.85 (6)	0.68 (4.3)	0.6 (4.5)
2	2400	600	552	9.3 (72)	6.8 (53)	4.8 (35)	4.1 (34)	2.5 (19)	1.7 (13)	1.3 (10)	1.2 (9.7)
1	4800	1200	1104	71 (500)	37 (270)	21 (160)	13 (98)	7.2 (55)	4.3 (33)	3.1 (24)	2.6 (21)

Table 18. Effective Resolution (Peak-to-Peak Resolution) vs. Gain and Output Data Rate (Bits), Mid Power Mode

Filter Word (Dec.)	Output Data Rate (SPS)	Output Data Rate (Zero Latency Mode) (SPS)	Gain							
			Gain = 1	Gain = 2	Gain = 4	Gain = 8	Gain = 16	Gain = 32	Gain = 64	Gain = 128
2047	2.34	0.586	24 (21.8)	24 (21.4)	23.6 (21)	23.3 (20.6)	22.6 (20.3)	22.1 (19.7)	21.6 (19.1)	20.9 (18.5)
1920	2.5	0.625	24 (21.8)	23.8 (21.4)	23.5 (21)	23 (20.6)	22.6 (20.3)	22 (19.7)	21.6 (19.1)	20.8 (18.5)
960	5	1.25	23.8 (21.2)	23.5 (21)	23.2 (20.6)	22.8 (20.2)	22.2 (19.7)	21.5 (19.2)	20.9 (18.5)	20.1 (17.6)
480	10	2.5	23.4 (20.8)	23.1 (20.4)	22.7 (20.1)	22.2 (19.6)	21.5 (19.1)	21 (18.5)	20.4 (17.8)	19.6 (17.1)
240	20	5	22.8 (20.3)	22.5 (20)	22.1 (19.6)	21.6 (19.1)	21.1 (18.5)	20.6 (17.9)	19.9 (17.3)	19.1 (16.5)
120	40	10	22.3 (19.7)	22 (19.4)	21.7 (19)	21.1 (18.5)	20.6 (18.1)	20.1 (17.5)	19.4 (16.8)	18.7 (16)
96	50	12.5	22.2 (19.5)	21.8 (19.2)	21.5 (18.9)	21 (18.3)	20.4 (17.9)	19.9 (17.3)	19.2 (16.6)	18.5 (15.8)
80	60	15	22.1 (19.4)	21.7 (19.1)	21.4 (18.7)	20.9 (18.2)	20.3 (17.8)	19.8 (17.2)	19.1 (16.4)	18.4 (15.7)
60	80	20	21.9 (19.2)	21.5 (18.9)	21.1 (18.5)	20.7 (18)	20.1 (17.6)	19.6 (16.9)	18.9 (16.2)	18.2 (15.5)
30	160	40	21.4 (18.8)	21 (18.9)	20.7 (18.5)	20.2 (17.5)	19.6 (17)	19.1 (16.3)	18.4 (15.8)	17.7 (15)
15	320	80	20.9 (18.2)	20.5 (17.8)	20.2 (17.5)	19.6 (17)	19 (16.5)	18.6 (15.9)	17.9 (15.3)	17.2 (14.6)
8	600	150	20.4 (17.7)	20 (17.3)	19.7 (17)	19 (16.4)	18.5 (15.9)	18.1 (15.3)	17.4 (14.8)	16.6 (13.9)
4	1200	300	19.8 (17.1)	19.4 (16.7)	19 (16.3)	18.3 (15.6)	17.9 (15.2)	17.5 (14.7)	16.8 (14)	16 (13.1)
2	2400	600	19 (16.1)	18.5 (15.5)	18 (15.1)	17.2 (14.2)	16.9 (14)	16.5 (13.6)	15.8 (12.9)	15 (12)
1	4800	1200	16.1 (13.3)	16 (13.2)	15.9 (12.9)	15.5 (12.6)	15.4 (12.5)	15.1 (12.2)	14.6 (11.7)	13.9 (10.9)

## RMS NOISE AND RESOLUTION

Sinc<sup>3</sup>Table 19. RMS Noise (Peak-to-Peak Noise) vs. Gain and Output Data Rate ( $\mu\text{V}$ ), Mid Power Mode

Filter Word (Dec.)	Output Data Rate (SPS)	Output Data Rate (Zero Latency Mode) (SPS)	$f_{3dB}$ (Hz)	Gain							
				Gain = 1	Gain = 2	Gain = 4	Gain = 8	Gain = 16	Gain = 32	Gain = 64	Gain = 128
2047	2.34	0.78	0.64	0.25 (1.5)	0.17 (1)	0.087 (0.58)	0.065 (0.4)	0.049 (0.27)	0.034 (0.19)	0.03 (0.16)	0.022 (0.11)
960	5	1.67	1.36	0.35 (2.2)	0.23 (1.3)	0.14 (0.82)	0.1 (0.58)	0.074 (0.43)	0.053 (0.31)	0.041 (0.22)	0.034 (0.17)
480	10	3.33	2.72	0.5 (3.1)	0.31 (1.9)	0.19 (1.3)	0.14 (0.89)	0.1 (0.63)	0.075 (0.44)	0.6 (0.35)	0.049 (0.28)
320	15	5	4.08	0.6 (3.8)	0.38 (2.4)	0.24 (1.6)	0.17 (1.1)	0.13 (0.8)	0.089 (0.54)	0.076 (0.46)	0.062 (0.35)
160	30	10	8.16	0.83 (5.6)	0.54 (3.3)	0.34 (2.2)	0.24 (1.6)	0.18 (1.1)	0.13 (0.77)	0.1 (0.65)	0.088 (0.53)
96	50	16.67	13.6	1.1 (7.5)	0.72 (4.4)	0.44 (2.9)	0.31 (2)	0.24 (1.5)	0.17 (1)	0.14 (0.82)	0.11 (0.7)
80	60	20	16.32	1.2 (7.7)	0.8 (4.8)	0.48 (3.1)	0.35 (2.2)	0.25 (1.6)	0.18 (1.1)	0.15 (0.94)	0.12 (0.77)
40	120	40	32.64	1.7 (11)	1.1 (7)	0.7 (4.6)	0.47 (3.2)	0.36 (2.2)	0.26 (1.7)	0.21 (1.5)	0.18 (1.1)
20	240	80	65.28	2.5 (16)	1.6 (9.7)	0.94 (6.2)	0.7 (5)	0.53 (3.2)	0.37 (2.3)	0.31 (2.1)	0.26 (1.8)
10	480	160	130.6	3.5 (24)	2.2 (15)	1.4 (9.3)	1 (7)	0.78 (5.3)	0.56 (3.9)	0.46 (3.1)	0.38 (2.5)
5	960	320	261.1	6.7 (53)	4.1 (34)	2.5 (19)	1.8 (14)	1.2 (8.7)	0.84 (6.4)	0.67 (5)	0.57 (3.9)
3	1600	533.33	435.2	25 (170)	13 (90)	7.1 (53)	4.2 (30)	2.4 (18)	1.5 (11)	1.1 (7.8)	0.89 (6.8)
2	2400	800	652.8	110 (740)	54 (360)	27 (200)	14 (110)	7.4 (51)	3.9 (29)	2.3 (16)	1.6 (12)
1	4800	1600	1306	880 (5800)	430 (3100)	220 (1500)	110 (760)	55 (400)	27 (180)	14 (110)	7.5 (56)

Table 20. Effective Resolution (Peak-to-Peak Resolution) vs. Gain and Output Data Rate (Bits), Mid Power Mode

Filter Word (Dec.)	Output Data Rate (SPS)	Output Data Rate (Zero Latency Mode) (SPS)	Gain							
			Gain = 1	Gain = 2	Gain = 4	Gain = 8	Gain = 16	Gain = 32	Gain = 64	Gain = 128
2047	2.34	0.78	24 (21.7)	23.8 (21.2)	23.6 (21)	23.2 (20.6)	22.6 (20.1)	22.1 (19.6)	21.3 (18.9)	20.7 (18.4)
960	5	1.67	23.8 (21.1)	23.4 (20.8)	23.1 (20.5)	22.6 (20)	22 (19.5)	21.5 (19)	20.8 (18.4)	20.1 (17.8)
480	10	3.33	23.3 (20.6)	22.9 (20.3)	22.6 (19.9)	22.1 (19.4)	21.5 (18.9)	21 (18.4)	20.3 (17.8)	19.6 (17.1)
320	15	5	23 (20.3)	22.6 (20)	22.3 (19.6)	21.8 (19.1)	21.2 (18.6)	20.7 (18.1)	20 (17.4)	19.3 (16.8)
160	30	10	22.5 (19.8)	22.1 (19.5)	21.8 (19.1)	21.3 (18.6)	20.7 (18.1)	20.2 (17.6)	19.5 (16.9)	18.8 (16.2)
96	50	16.67	22.1 (19.4)	21.7 (19.1)	21.4 (18.7)	20.9 (18.2)	20.3 (17.7)	19.8 (17.2)	19.1 (16.5)	18.4 (15.8)
80	60	20	22 (19.3)	21.6 (19)	21.3 (18.6)	20.8 (18.1)	20.2 (17.6)	19.7 (17.1)	19.1 (16.3)	18.3 (15.6)
40	120	40	21.5 (18.8)	21.1 (18.5)	20.8 (18.1)	20.3 (17.6)	19.7 (17.1)	19.2 (16.5)	18.5 (15.7)	17.7 (15.1)
20	240	80	21 (18.3)	20.6 (18)	20.3 (17.6)	19.8 (17)	19.2 (16.6)	18.7 (16)	18 (15.2)	17.2 (14.4)
10	480	160	20.4 (17.7)	20.1 (17.3)	19.8 (17)	19.2 (16.4)	18.6 (15.9)	18.1 (15.3)	17.4 (14.6)	16.7 (13.9)
5	960	320	19.5 (16.5)	19.2 (16.2)	19 (16)	18.4 (15.4)	18 (15.1)	17.5 (14.6)	16.8 (13.9)	16.1 (13.3)
3	1600	533.33	17.6 (14.8)	17.5 (14.8)	17.4 (14.5)	17.2 (14.3)	17 (14.1)	16.7 (13.8)	16.1 (13.3)	15.4 (12.6)
2	2400	800	15.5 (12.7)	15.5 (12.7)	15.5 (12.6)	15.4 (12.6)	15.4 (12.6)	15.3 (12.4)	15 (12.3)	14.6 (11.7)
1	4800	1600	12.5 (9.7)	12.5 (9.7)	12.5 (9.7)	12.5 (9.7)	12.5 (9.6)	12.5 (9.6)	12.4 (9.5)	12.4 (9.4)

## Post Filters

Table 21. RMS Noise (Peak-to-Peak Noise) vs. Gain and Output Data Rate ( $\mu\text{V}$ ), Mid Power Mode

Output Data Rate (SPS)	Gain = 1	Gain = 2	Gain = 4	Gain = 8	Gain = 16	Gain = 32	Gain = 64	Gain = 128
16.67	1.1 (6.3)	0.69 (4)	0.41 (2.5)	0.31 (2)	0.23 (1.4)	0.17 (0.96)	0.13 (0.79)	0.11 (0.61)
20	1.1 (6.9)	0.7 (4)	0.41 (2.5)	0.33 (2.1)	0.23 (1.5)	0.18 (0.96)	0.14 (0.81)	0.12 (0.67)
25	1.2 (8)	0.8 (4.6)	0.46 (2.8)	0.36 (2.3)	0.25 (1.5)	0.17 (1)	0.15 (0.9)	0.12 (0.74)
27.27	1.3 (9.2)	0.82 (4.8)	0.48 (2.8)	0.36 (2.3)	0.28 (1.6)	0.19 (1.1)	0.16 (1)	0.13 (0.79)



## RMS NOISE AND RESOLUTION

Table 22. Effective Resolution (Peak-to-Peak Resolution) vs. Gain and Output Data Rate (Bits), Mid Power Mode

Output Data Rate (SPS)	Gain = 1	Gain = 2	Gain = 4	Gain = 8	Gain = 16	Gain = 32	Gain = 64	Gain = 128
16.67	22.1 (19.6)	21.8 (19.2)	21.5 (18.9)	20.9 (18.3)	20.4 (17.8)	19.8 (17.3)	19.2 (16.6)	18.4 (16)
20	22.1 (19.5)	21.8 (19.2)	21.5 (18.9)	20.9 (18.2)	20.4 (17.7)	19.8 (17.3)	19 (16.6)	18.3 (15.8)
25	22 (19.2)	21.6 (19.1)	21.4 (18.8)	20.7 (18.1)	20.3 (17.6)	19.7 (17.2)	18.9 (16.4)	18.2 (15.7)
27.27	21.9 (19)	21.5 (19)	21.3 (18.8)	20.7 (18.1)	21.1 (17.6)	19.7 (17.1)	18.9 (16.3)	18.2 (15.6)

Fast Settling Filter (Sinc<sup>4</sup> + Sinc<sup>1</sup>)

Table 23. RMS Noise (Peak-to-Peak Noise) vs. Gain and Output Data Rate (μV), Mid Power Mode (Average by 16)

Filter Word (Dec.)	Output Data Rate (SPS)	Gain = 1	Gain = 2	Gain = 4	Gain = 8	Gain = 16	Gain = 32	Gain = 64	Gain = 128
96	3.125	0.36 (2.4)	0.23 (1.5)	0.15 (0.82)	0.1 (0.71)	0.078 (0.44)	0.056 (0.35)	0.045 (0.26)	0.038 (0.21)
30	10	0.67 (4.2)	0.44 (2.7)	0.26 (1.6)	0.18 (1.1)	0.14 (0.8)	0.1 (0.54)	0.08 (0.48)	0.067 (0.41)
6	50	1.5 (9)	0.96 (6.1)	0.57 (3.7)	0.42 (2.6)	0.32 (1.9)	0.22 (1.5)	0.18 (1.1)	0.15 (0.95)
5	60	1.6 (9.3)	1 (7.7)	0.62 (4)	0.46 (3)	0.33 (2)	0.24 (1.6)	0.2 (1.3)	0.17 (1.2)
2	150	2.5 (15)	1.6 (11)	1 (7.2)	0.76 (4.9)	0.57 (3.7)	0.41 (2.7)	0.32 (2.4)	0.29 (1.9)
1	300	5.2 (21)	3.1 (19)	1.8 (11)	1.4 (9.8)	0.92 (6.2)	0.62 (4.2)	0.49 (3)	0.41 (3)

Table 24. Effective Resolution (Peak-to-Peak Resolution) vs. Gain and Output Data Rate (Bits), Mid Power Mode (Average by 16)

Filter Word (Dec.)	Output Data Rate (SPS)	Gain = 1	Gain = 2	Gain = 4	Gain = 8	Gain = 16	Gain = 32	Gain = 64	Gain = 128
96	3.125	23.7 (21)	23.4 (20.7)	23 (20.5)	22.5 (19.8)	21.9 (19.4)	21.4 (18.8)	20.7 (18.2)	20 (17.5)
30	10	22.8 (20.2)	22.4 (19.8)	22.2 (19.5)	21.7 (19.1)	21 (18.6)	20.6 (18.1)	19.9 (17.3)	19.1 (16.5)
6	50	21.7 (19.1)	21.3 (18.6)	21.1 (18.4)	20.5 (17.9)	19.9 (17.3)	19.4 (16.7)	18.7 (16)	18 (15.2)
5	60	21.5 (19)	21.2 (18.4)	20.9 (18.2)	20.4 (17.8)	19.8 (17.2)	19.3 (16.6)	18.5 (15.9)	17.8 (15)
2	150	20.9 (18.3)	20.5 (17.8)	20.2 (17.4)	19.6 (17)	19.1 (16.4)	18.6 (15.8)	17.9 (15.2)	17.1 (14.3)
1	300	19.9 (17.3)	19.6 (17)	19.4 (16.8)	18.8 (16)	18.4 (15.6)	17.9 (15.2)	17.3 (14.7)	16.5 (13.7)

Fast Settling Filter (Sinc<sup>3</sup> + Sinc<sup>1</sup>)

Table 25. RMS Noise (Peak-to-Peak Noise) vs. Gain and Output Data Rate (μV), Mid Power Mode (Average by 16)

Filter Word (Dec.)	Output Data Rate (SPS)	Gain = 1	Gain = 2	Gain = 4	Gain = 8	Gain = 16	Gain = 32	Gain = 64	Gain = 128
96	3.125	0.39 (2.4)	0.25 (1.5)	0.16 (1)	0.11 (0.67)	0.08 (0.48)	0.058 (0.31)	0.047 (0.27)	0.039 (0.23)
30	10	0.71 (4.2)	0.43 (2.5)	0.27 (1.6)	0.19 (1.1)	0.15 (1)	0.098 (0.64)	0.083 (0.47)	0.068 (0.4)
6	50	1.5 (9.5)	0.93 (6)	0.59 (3.8)	0.43 (2.6)	0.32 (2.1)	0.22 (1.5)	0.18 (1.1)	0.15 (0.98)
5	60	1.6 (11)	1 (6.9)	0.66 (4.2)	0.46 (2.8)	0.35 (2.3)	0.24 (1.6)	0.2 (1.2)	0.17 (1.1)
2	150	6 (37)	3.2 (20)	1.8 (11)	1 (7.2)	0.63 (4.5)	0.43 (3)	0.33 (2.2)	0.27 (1.8)
1	300	44 (320)	23 (160)	12 (83)	5.7 (41)	3 (20)	1.6 (9.9)	0.84 (6.4)	0.56 (3.5)

Table 26. Effective Resolution (Peak-to-Peak Resolution) vs. Gain and Output Data Rate (Bits), Mid Power Mode (Average by 16)

Filter Word (Dec.)	Output Data Rate (SPS)	Gain = 1	Gain = 2	Gain = 4	Gain = 8	Gain = 16	Gain = 32	Gain = 64	Gain = 128
96	3.125	23.6 (21)	23.3 (20.7)	22.9 (20.3)	22.5 (19.8)	21.9 (19.3)	21.4 (18.9)	20.7 (18.1)	19.9 (17.4)
30	10	22.7 (20.2)	22.5 (19.9)	22.2 (19.6)	21.7 (19.1)	21 (18.3)	20.6 (17.9)	19.8 (17.3)	19.1 (16.6)
6	50	21.7 (19)	21.4 (18.7)	21 (18.3)	20.5 (17.9)	19.9 (17.2)	19.4 (16.7)	18.7 (16.1)	18 (15.3)
5	60	21.5 (18.8)	21.2 (18.5)	20.9 (18.2)	20.4 (17.8)	19.8 (17.1)	19.3 (16.6)	18.6 (16)	17.8 (15.1)
2	150	19.7 (17)	19.6 (16.9)	19.4 (16.8)	19.2 (16.4)	18.9 (16.1)	18.5 (15.7)	17.8 (15.1)	17.1 (14.4)
1	300	16.8 (13.9)	16.7 (13.9)	16.7 (13.9)	16.7 (13.9)	16.7 (13.9)	16.6 (13.9)	16.5 (13.6)	16.1 (13.4)



## RMS NOISE AND RESOLUTION

## LOW POWER MODE

Sinc<sup>4</sup>Table 27. RMS Noise (Peak-to-Peak Noise) vs. Gain and Output Data Rate ( $\mu V$ ), Low Power Mode

Filter Word (Dec.)	Output Data Rate (SPS)	Output Data Rate (Zero Latency Mode) (SPS)	$f_{3dB}$ (Hz)	Gain								
				Gain = 1	Gain = 2	Gain = 4	Gain = 8	Gain = 16	Gain = 32	Gain = 64	Gain = 128	
2047	1.17	0.293	0.269	0.22 (1.2)	0.15 (0.89)	0.095 (0.67)	0.071 (0.41)	0.053 (0.26)	0.043 (0.2)	0.035 (0.16)	0.024 (0.12)	
1920	1.25	0.3125	0.288	0.24 (1.5)	0.15 (0.89)	0.095 (0.67)	0.071 (0.41)	0.053 (0.26)	0.043 (0.2)	0.035 (0.16)	0.024 (0.12)	
960	2.5	0.625	0.575	0.37 (2.1)	0.23 (1.2)	0.13 (0.82)	0.1 (0.61)	0.068 (0.37)	0.055 (0.26)	0.041 (0.23)	0.035 (0.17)	
480	5	1.25	1.15	0.5 (3)	0.3 (1.7)	0.18 (1.2)	0.13 (0.77)	0.099 (0.56)	0.078 (0.39)	0.06 (0.31)	0.052 (0.26)	
240	10	2.5	2.3	0.65 (4.1)	0.42 (2.5)	0.26 (1.9)	0.2 (1.1)	0.14 (0.8)	0.1 (0.6)	0.085 (0.5)	0.072 (0.43)	
120	20	5	4.6	0.9 (5.8)	0.61 (3.5)	0.38 (2.5)	0.28 (1.7)	0.2 (1.2)	0.15 (0.85)	0.12 (0.68)	0.096 (0.6)	
60	40	10	9.2	1.3 (8)	0.82 (5)	0.53 (3.7)	0.38 (2.4)	0.29 (1.8)	0.21 (1)	0.17 (0.95)	0.14 (0.9)	
48	50	12.5	11.5	1.4 (9.3)	0.95 (6)	0.6 (4.2)	0.46 (2.8)	0.32 (2.1)	0.24 (1.5)	0.2 (1.1)	0.16 (1)	
40	60	15	13.8	1.6 (10)	0.99 (6.6)	0.64 (4.5)	0.47 (3.2)	0.35 (2.2)	0.26 (1.7)	0.21 (1.3)	0.17 (1.1)	
30	80	20	18.4	1.8 (12)	1.2 (7.5)	0.77 (5.1)	0.55 (3.7)	0.4 (2.7)	0.3 (2)	0.25 (1.6)	0.19 (1.3)	
15	160	40	36.8	2.6 (17)	1.8 (11)	1.1 (7.2)	0.85 (5.7)	0.56 (3.9)	0.41 (2.5)	0.33 (2.1)	0.28 (1.6)	
8	300	75	69	3.7 (24)	2.5 (17)	1.6 (11)	1.2 (7.5)	0.87 (5.6)	0.58 (3.9)	0.48 (2.9)	0.39 (2.6)	
4	600	150	138	5.2 (35)	4 (24)	2.6 (17)	2.1 (13)	1.4 (8.5)	1 (6)	0.76 (5.2)	0.6 (3.9)	
2	1200	300	276	9.4 (57)	7.6 (47)	5.8 (36)	4.9 (32)	3 (19)	1.9 (11)	1.4 (9)	1.3 (7.8)	
1	2400	600	552	72 (470)	39 (240)	22 (130)	16 (110)	8 (49)	4.8 (29)	3.3 (21)	2.6 (18)	

Table 28. Effective Resolution (Peak-to-Peak Resolution) vs. Gain and Output Data Rate, Low Power Mode

Filter Word (Dec.)	Output Data Rate (SPS)	Output Data Rate (Zero Latency Mode) (SPS)	Gain								
			Gain = 1	Gain = 2	Gain = 4	Gain = 8	Gain = 16	Gain = 32	Gain = 64	Gain = 128	
2047	1.17	0.29311	24 (22)	23.8 (21.4)	23.7 (20.9)	23.2 (20.5)	22.7 (20.2)	21.8 (19.7)	21.3 (18.9)	20.6 (18.3)	
1920	1.25	0.3125	24 (21.7)	23.8 (21.3)	23.6 (20.8)	23.1 (20.5)	22.6 (20.1)	21.8 (19.6)	21.2 (18.9)	20.6 (18.3)	
960	2.5	0.625	23.7 (21.2)	23.4 (21)	23.2 (20.5)	22.6 (20)	22.1 (19.7)	21.4 (19.2)	20.8 (18.4)	20.1 (17.8)	
480	5	1.25	23.3 (20.7)	23 (20.5)	22.7 (20)	22.1 (19.6)	21.6 (19.1)	20.9 (18.6)	20.3 (17.9)	19.5 (17.2)	
240	10	2.5	22.9 (20.2)	22.5 (19.9)	22.2 (19.4)	21.6 (19.1)	21.1 (18.6)	20.5 (18)	19.8 (17.2)	19.1 (16.5)	
120	20	5	22.4 (19.7)	22 (19.4)	21.7 (18.9)	21.1 (18.5)	20.6 (18)	20 (17.5)	19.3 (16.8)	18.6 (16)	
60	40	10	21.9 (19.2)	21.5 (18.9)	21.2 (18.4)	20.6 (18)	20.1 (17.4)	19.5 (17.3)	18.8 (16.3)	18.1 (15.4)	
48	50	12.5	21.7 (19)	21.3 (18.7)	21 (18.2)	20.4 (17.8)	19.9 (17.2)	19.3 (16.7)	18.6 (16.1)	17.9 (15.2)	
40	60	15	21.6 (18.9)	21.2 (18.5)	20.9 (18.1)	20.3 (17.6)	19.8 (17.1)	19.2 (16.5)	18.5 (15.9)	17.8 (15.1)	
30	80	20	21.4 (18.7)	21 (18.3)	20.6 (17.9)	20.1 (17.4)	19.6 (16.8)	19 (16.2)	18.3 (15.6)	17.6 (14.9)	
15	160	40	20.9 (18.2)	20.4 (17.8)	20.1 (17.4)	19.5 (16.8)	19.1 (16.3)	18.5 (15.7)	17.8 (15.2)	17.1 (14.5)	
8	300	75	20.4 (17.7)	19.9 (17.2)	19.6 (16.8)	19 (16.3)	18.5 (15.8)	18 (15.3)	17.3 (14.7)	16.6 (13.9)	
4	600	150	19.9 (17.1)	19.3 (16.7)	18.9 (16.2)	18.2 (15.6)	17.8 (15.2)	17.3 (14.7)	16.7 (13.9)	16 (13.3)	
2	1200	300	19 (16.4)	18.3 (15.7)	17.7 (15.1)	17 (14.3)	16.7 (14)	16.3 (13.8)	15.7 (13.1)	14.9 (12.3)	
1	2400	600	16.1 (13.4)	16 (13.4)	15.8 (13.3)	15.3 (12.5)	15.2 (12.5)	15 (12.4)	14.5 (11.9)	13.9 (11)	

## RMS NOISE AND RESOLUTION

Sinc<sup>3</sup>Table 29. RMS Noise (Peak-to-Peak Noise) vs. Gain and Output Data Rate ( $\mu\text{V}$ ), Low Power Mode

Filter Word (Dec.)	Output Data Rate (SPS)	Output Data Rate (Zero Latency Mode) (SPS)	$f_{3\text{dB}}$ (Hz)	Gain							
				Gain = 1	Gain = 2	Gain = 4	Gain = 8	Gain = 16	Gain = 32	Gain = 64	Gain = 128
2047	1.17	0.39	0.32	0.26 (1.5)	0.17 (0.9)	0.099 (0.6)	0.072 (0.36)	0.055 (0.27)	0.039 (0.21)	0.032 (0.16)	0.026 (0.13)
480	5	1.67	1.36	0.51 (3.1)	0.31 (1.9)	0.2 (1.3)	0.15 (0.86)	0.11 (0.65)	0.078 (0.45)	0.063 (0.37)	0.05 (0.28)
240	10	3.33	2.72	0.75 (4.5)	0.45 (2.8)	0.29 (2)	0.21 (1.3)	0.16 (0.9)	0.11 (0.65)	0.085 (0.51)	0.071 (0.39)
160	15	5	4.08	0.88 (5.5)	0.55 (3.3)	0.3 (2.4)	0.26 (1.6)	0.19 (1.2)	0.14 (0.79)	0.1 (0.62)	0.089 (0.53)
80	30	10	8.16	1.3 (7.8)	0.77 (4.9)	0.47 (3.3)	0.36 (2.2)	0.27 (1.7)	0.19 (1.2)	0.15 (0.94)	0.12 (0.72)
48	50	16.67	13.6	1.7 (9.9)	1 (6.4)	0.63 (4.6)	0.47 (3.1)	0.36 (2.2)	0.26 (1.7)	0.2 (1.3)	0.16 (1)
40	60	20	16.32	1.8 (12)	1.1 (7)	0.71 (5)	0.52 (3.4)	0.39 (2.5)	0.27 (1.8)	0.21 (1.4)	0.18 (1.3)
20	120	40	32.64	2.5 (17)	1.6 (10)	0.9 (6.17)	0.73 (5)	0.55 (3.7)	0.41 (2.5)	0.3 (1.9)	0.26 (1.6)
10	240	80	65.28	3.5 (25)	2.4 (16)	1.5 (9.9)	1.1 (7.6)	0.8 (5.3)	0.56 (3.5)	0.45 (2.8)	0.37 (2.3)
5	480	160	130.6	6.8 (48)	4.3 (32)	2.6 (19)	2 (15)	1.3 (9)	0.9 (6.5)	0.7 (4.5)	0.55 (3.3)
3	800	266.67	217.6	25 (180)	13 (98)	7.4 (53)	4.5 (34)	2.7 (18)	1.6 (11)	1.1 (7.7)	0.91 (6)
2	1200	400	326.4	110 (740)	55 (390)	28 (180)	15 (100)	7.6 (57)	4 (32)	2.4 (16)	1.6 (12)
1	2400	800	652.8	870 (5600)	430 (2900)	220 (1400)	110 (670)	56 (370)	28 (180)	14 (100)	7.6 (52)

Table 30. Effective Resolution (Peak-to-Peak Resolution) vs. Gain and Output Data Rate, Low Power Mode

Filter Word (Dec.)	Output Data Rate (SPS)	Output Data Rate (Zero Latency Mode) (SPS)	Gain							
			Gain = 1	Gain = 2	Gain = 4	Gain = 8	Gain = 16	Gain = 32	Gain = 64	Gain = 128
2047	1.17	0.39	24 (21.7)	23.8 (21.4)	23.6 (21)	23 (20.7)	22.4 (20.1)	21.9 (19.5)	21.2 (18.9)	20.5 (18.2)
480	5	1.67	23.2 (20.6)	22.9 (20.3)	22.6 (19.9)	22 (19.5)	21.4 (18.9)	20.9 (18.4)	20.2 (17.7)	19.6 (17.1)
240	10	3.33	22.7 (20.1)	22.4 (19.8)	22.1 (19.3)	21.5 (18.9)	20.9 (18.4)	20.4 (17.9)	19.8 (17.2)	19.1 (16.6)
160	15	5	22.4 (19.8)	22.1 (19.5)	21.8 (19)	21.2 (18.6)	20.6 (18)	20.1 (17.6)	19.5 (16.9)	18.8 (16.2)
80	30	10	21.9 (19.3)	21.6 (19)	21.3 (18.5)	20.7 (18.1)	20.1 (17.5)	19.6 (17)	19 (16.3)	18.3 (15.7)
48	50	16.67	21.5 (18.9)	21.2 (18.6)	20.9 (18.1)	20.3 (17.6)	19.7 (17.1)	19.2 (16.5)	18.6 (15.9)	17.9 (15.2)
40	60	20	21.4 (18.7)	21.1 (18.4)	20.8 (17.9)	20.2 (17.5)	19.6 (16.9)	19.1 (16.4)	18.5 (15.8)	17.7 (15.1)
20	120	40	20.9 (18.2)	20.6 (17.9)	20.3 (17.4)	19.7 (16.9)	19.1 (16.4)	18.6 (15.9)	18 (15.3)	17.2 (14.6)
10	240	80	20.4 (17.6)	20 (17.2)	19.7 (16.9)	19.1 (16.3)	18.6 (15.9)	18.1 (15.4)	17.4 (14.8)	16.7 (14.1)
5	480	160	19.5 (16.7)	19.2 (16.3)	18.8 (16)	18.2 (15.4)	17.9 (15.1)	17.4 (14.6)	16.8 (14.1)	16.1 (13.5)
3	800	266.67	17.6 (14.8)	17.5 (14.6)	17.4 (14.5)	17.1 (14.2)	16.8 (14.1)	16.6 (13.8)	16.1 (13.3)	15.4 (12.7)
2	1200	400	15.5 (12.7)	15.5 (12.7)	15.4 (12.7)	15.4 (12.6)	15.3 (12.4)	15.2 (12.3)	15 (12.2)	14.5 (11.6)
1	2400	800	12.5 (9.8)	12.5 (9.8)	12.5 (9.8)	12.5 (9.8)	12.5 (9.7)	12.5 (9.7)	12.5 (9.6)	12.3 (9.6)

## Post Filters

Table 31. RMS Noise (Peak-to-Peak Noise) vs. Gain and Output Data Rate ( $\mu\text{V}$ ), Low Power Mode

Output Data Rate (SPS)	Gain = 1	Gain = 2	Gain = 4	Gain = 8	Gain = 16	Gain = 32	Gain = 64	Gain = 128
16.67	1.7 (12)	0.96 (5.8)	0.65 (4)	0.45 (2.6)	0.34 (1.9)	0.25 (1.5)	0.2 (1.2)	0.16 (0.92)
20	1.7 (11)	1.1 (6.4)	0.65 (4.2)	0.46 (2.6)	0.36 (1.9)	0.26 (1.5)	0.21 (1.2)	0.17 (0.93)
25	1.8 (11)	1.1 (6.7)	0.68 (4.2)	0.52 (2.7)	0.37 (2)	0.26 (1.6)	0.22 (1.2)	0.17 (1.1)
27.27	1.9 (11)	1.1 (7.3)	0.69 (4.4)	0.54 (2.9)	0.4 (2.1)	0.27 (1.8)	0.23 (1.4)	0.18 (1.3)

## RMS NOISE AND RESOLUTION

Table 32. Effective Resolution (Peak-to-Peak Resolution) vs. Gain and Output Data Rate (Bits), Low Power Mode

Output Data Rate (SPS)	Gain = 1	Gain = 2	Gain = 4	Gain = 8	Gain = 16	Gain = 32	Gain = 64	Gain = 128
16.67	21.5 (18.8)	21.3 (18.7)	20.9 (18.2)	21.4 (17.9)	19.8 (17.3)	19.3 (16.7)	18.6 (16.1)	17.9 (15.4)
20	21.5 (18.8)	21.2 (18.6)	20.9 (18.2)	20.4 (17.9)	19.7 (17.3)	19.2 (16.7)	18.6 (16.1)	17.8 (15.4)
25	21.4 (18.8)	21.2 (18.5)	20.8 (18.2)	20.2 (17.8)	19.7 (17.3)	19.2 (16.6)	18.5 (15.9)	17.8 (15.1)
27.27	21.3 (18.7)	21.1 (18.4)	20.8 (18.1)	20.2 (17.7)	19.6 (17.2)	19.1 (16.4)	18.4 (15.8)	17.7 (14.9)

Fast Settling Filter (Sinc<sup>4</sup> + Sinc<sup>1</sup>)

Table 33. RMS Noise (Peak-to-Peak Noise) vs. Gain and Output Data Rate (μV), Low Power Mode (Average by 8)

Filter Word (Dec.)	Output Data Rate (SPS)	Gain = 1	Gain = 2	Gain = 4	Gain = 8	Gain = 16	Gain = 32	Gain = 64	Gain = 128
96	3.125	0.53 (3.4)	0.34 (2.2)	0.19 (1.2)	0.16 (0.97)	0.1 (0.61)	0.082 (0.48)	0.065 (0.38)	0.058 (0.37)
30	10	0.89 (5.4)	0.6 (3.6)	0.36 (2.2)	0.27 (1.8)	0.21 (1.2)	0.15 (0.93)	0.12 (0.65)	0.093 (0.59)
6	50	2.1 (12)	1.4 (8.3)	0.82 (5.6)	0.64 (3.9)	0.43 (2.7)	0.33 (2.1)	0.25 (1.6)	0.21 (1.4)
5	60	2.2 (13)	1.4 (9.7)	0.93 (6.5)	0.71 (4.2)	0.5 (3.1)	0.35 (2.4)	0.28 (1.7)	0.23 (1.5)
2	150	3.7 (25)	2.5 (18)	1.5 (10)	1.3 (7.5)	0.86 (5.6)	0.59 (3.5)	0.47 (3.2)	0.39 (2.4)
1	300	8.4 (52)	5.4 (34)	3.3 (21)	2.6 (16)	1.6 (9.8)	0.97 (6.1)	0.75 (5.4)	0.63 (4.7)

Table 34. Effective Resolution (Peak-to-Peak Resolution) vs. Gain and Output Data Rate (Bits), Low Power Mode (Average by 8)

Filter Word (Dec.)	Output Data Rate (SPS)	Gain = 1	Gain = 2	Gain = 4	Gain = 8	Gain = 16	Gain = 32	Gain = 64	Gain = 128
96	3.125	23.2 (20.5)	22.8 (20.1)	22.7 (20)	21.9 (19.3)	21.5 (19)	20.9 (18.3)	20.2 (17.6)	19.4 (16.7)
30	10	22.4 (19.8)	22 (19.4)	21.7 (19.1)	21.1 (18.4)	20.5 (18)	20 (17.4)	19.4 (16.9)	18.7 (16)
6	50	21.2 (18.6)	20.8 (18.1)	20.5 (17.8)	19.9 (17.3)	19.5 (16.8)	18.9 (16.2)	18.3 (15.6)	17.5 (14.8)
5	60	21.1 (18.5)	20.7 (18)	20.4 (17.6)	19.8 (17.2)	19.3 (16.6)	18.8 (16)	18.1 (15.5)	17.4 (14.7)
2	150	20.4 (17.6)	19.9 (17.1)	19.6 (16.9)	18.9 (16.3)	18.5 (15.8)	18 (15.4)	17.3 (14.6)	16.6 (14)
1	300	19.2 (16.6)	18.8 (16.2)	18.5 (15.9)	17.9 (15.2)	17.6 (15)	17.3 (14.7)	16.7 (13.8)	15.9 (13)

Fast Settling Filter (Sinc<sup>3</sup> + Sinc<sup>1</sup>)

Table 35. RMS Noise (Peak-to-Peak Noise) vs. Gain and Output Data Rate (μV), Low Power Mode (Average by 8)

Filter Word (Dec.)	Output Data Rate (SPS)	Gain = 1	Gain = 2	Gain = 4	Gain = 8	Gain = 16	Gain = 32	Gain = 64	Gain = 128
96	3.125	0.53 (3.6)	0.33 (2.1)	0.21 (1.4)	0.15 (0.93)	0.11 (0.6)	0.073 (0.44)	0.064 (0.39)	0.051 (0.29)
30	10	0.92 (5.4)	0.58 (3.4)	0.4 (2.3)	0.28 (1.6)	0.2 (1.1)	0.14 (0.79)	0.11 (0.62)	0.094 (0.51)
6	50	2.1 (13)	1.3 (8.3)	0.83 (6)	0.61 (4.1)	0.44 (3)	0.33 (2.1)	0.26 (1.6)	0.21 (1.3)
5	60	2.3 (14)	1.5 (8.6)	0.87 (6.6)	0.7 (4.4)	0.5 (3.3)	0.36 (2.3)	0.3 (1.7)	0.23 (1.4)
2	150	11 (72)	5.9 (39)	3.2 (23)	1.9 (15)	1.1 (8.5)	0.7 (4.7)	0.5 (3.3)	0.4 (2.4)
1	300	88 (530)	45 (250)	22 (140)	11 (82)	5.8 (40)	3 (22)	01.6 (11)	0.94 (6.3)

Table 36. Effective Resolution (Peak-to-Peak Resolution) vs. Gain and Output Data Rate (Bits), Low Power Mode (Average by 8)

Filter Word (Dec.)	Output Data Rate (SPS)	Gain = 1	Gain = 2	Gain = 4	Gain = 8	Gain = 16	Gain = 32	Gain = 64	Gain = 128
96	3.125	23.2 (20.4)	22.8 (20.2)	22.5 (19.8)	22 (19.4)	21.4 (19)	21 (18.4)	20.2 (17.6)	19.6 (17)
30	10	22.4 (19.8)	22 (19.5)	21.6 (19)	21.1 (18.6)	20.6 (18.1)	20.1 (17.6)	19.4 (16.9)	18.7 (16.2)
6	50	21.2 (18.6)	20.9 (18.2)	20.5 (17.7)	20 (17.2)	19.4 (16.7)	18.9 (16.2)	18.2 (15.6)	17.5 (14.9)
5	60	21 (18.4)	20.7 (18.1)	20.4 (17.5)	19.8 (17)	19.3 (16.5)	18.7 (16.1)	18 (15.5)	17.4 (14.8)
2	150	18.7 (16.1)	18.7 (16)	18.6 (15.8)	18.3 (15.3)	18.1 (15.2)	17.8 (15)	17.3 (14.6)	16.6 (14)
1	300	15.8 (13.2)	15.8 (13.2)	15.8 (13.2)	15.7 (12.9)	15.7 (12.9)	15.7 (12.8)	15.6 (12.8)	15.3 (12.6)

## GETTING STARTED

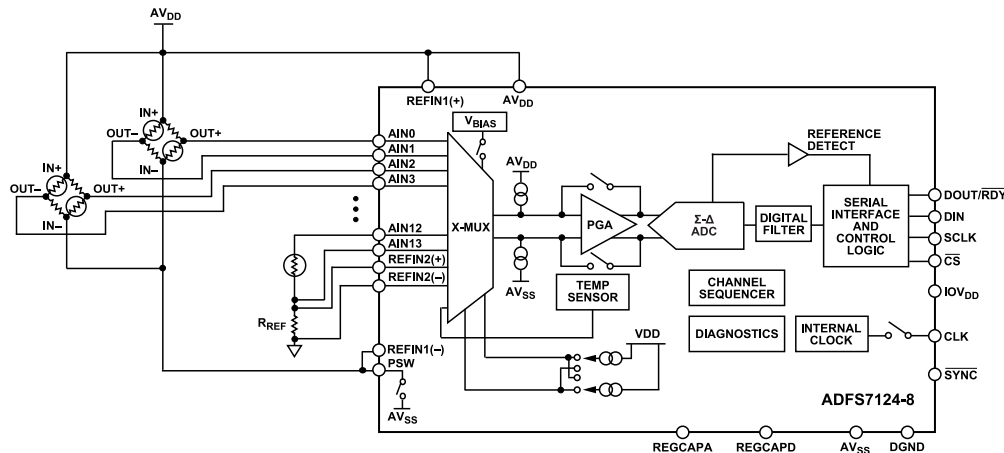

NOTES  
1. SIMPLIFIED BLOCK DIAGRAM SHOWN.

Figure 64. Basic Connection Diagram

## OVERVIEW

The ADFS7124-8 is a low power ADC that incorporates a  $\Sigma$ - $\Delta$  modulator, buffer, reference, gain stage, and on-chip digital filtering, which is intended for the measurement of wide dynamic ranges, low frequency signals (such as those in pressure transducers), weigh scales, and temperature measurement applications.

## Power Modes

The ADFS7124-8 offers three power modes: full power mode, mid power mode, and low power mode. This allows total flexibility in terms of speed, RMS noise, and current consumption.

## Analog Inputs

The device can have 8 differential or 15 pseudo differential analog inputs. The analog inputs can be buffered or unbuffered. The ADFS7124-8 uses flexible multiplexing; thus, any analog input pin can be selected as a positive input (AINP) and any analog input pin can be selected as a negative input (AINM).

## Multiplexer

The on-chip multiplexer increases the channel count of the device. Because the multiplexer is included on chip, any channel changes are synchronized with the conversion process.

## Reference

The device contains a 2.5 V reference, which has a drift of 15 ppm/ $^{\circ}$ C maximum.

Reference buffers are also included on chip, which can be used with externally applied references.

## Programmable Gain Amplifier (PGA)

The analog input signal can be amplified using the PGA. The PGA allows gains of 1, 2, 4, 8, 16, 32, 64, and 128.

## Burnout Currents

Two burnout currents, which can be programmed to 500 nA, 2  $\mu$ A, or 4  $\mu$ A, are included on chip to detect the presence of the external sensor.

## $\Sigma$ - $\Delta$ ADC and Filter

The ADFS7124-8 contains a fourth-order  $\Sigma$ - $\Delta$  modulator followed by a digital filter. The device has the following filter options:

- ▶ Sinc<sup>4</sup>
- ▶ Sinc<sup>3</sup>
- ▶ Fast filter
- ▶ Post filter
- ▶ Zero latency

## Channel Sequencer

The ADFS7124-8 allows up to 16 configurations, or channels. These channels can consist of analog inputs, reference inputs, or power supplies such that diagnostic functions, such as power supply monitoring, can be interleaved with conversions. The sequencer automatically converts all enabled channels. When each enabled channel is selected, the time required to generate the conversion is equal to the settling time for the selected channel.

## Per Channel Configuration

The ADFS7124-8 allows up to eight different setups, each setup consisting of a gain, output data rate, filter type, and a reference source. Each channel is then linked to a setup.

## GETTING STARTED

### Serial Interface

The ADFS7124-8 has a 3-wire or 4-wire SPI. The on-chip registers are accessed through the serial interface.

### Clock

The device has an internal 614.4 kHz clock. Use either this clock or an external clock as the clock source for the device. The internal clock can also be made available on a pin if a clock source is required for external circuitry.

### Temperature Sensor

The on-chip temperature sensor monitors the die temperature.

### Digital Outputs

The ADFS7124-8 has four general-purpose digital outputs. These can be used for driving external circuitry. For example, an external multiplexer can be controlled by these outputs.

### Calibration

Both internal calibration and system calibration are included on chip; therefore, there is the option of removing offset or gain errors internal to the device only, or removing the offset or gain errors of the complete end system.

### Excitation Currents

The device contains two excitation currents that can be set independently to 0.1  $\mu\text{A}$ , 50  $\mu\text{A}$ , 100  $\mu\text{A}$ , 250  $\mu\text{A}$ , 500  $\mu\text{A}$ , 750  $\mu\text{A}$ , or 1 mA.

### Bias Voltage

A bias voltage generator is included on chip so that signals from thermocouples can be biased suitably. The bias voltage is set to  $(AV_{DD} - AV_{SS})/2$  and can be made available on any input. It can supply multiple channels.

### Bridge Power Switch (PSW)

A low-side power switch allows the user to power down bridges that are interfaced to the ADC.

### Diagnostics

The ADFS7124-8 includes numerous diagnostic features such as:

- ▶ Reference detection
- ▶ Overvoltage/undervoltage detection
- ▶ CRC on SPI communications
- ▶ CRC on the memory map
- ▶ SPI read/write checks

These diagnostics allow a high level of fault coverage in an application.

## POWER SUPPLIES

The ADFS7124-8 operates with an analog power supply voltage from 2.7 V to 3.6 V in low or mid power mode and from 2.9 V to 3.6 V in full power mode. The device accepts a digital power supply from 1.65 V to 3.6 V.

The device has two independent power supply pins:  $AV_{DD}$  and  $IOV_{DD}$ .

- ▶  $AV_{DD}$  is referred to  $AV_{SS}$ .  $AV_{DD}$  powers the internal analog regulator that supplies the ADC.
- ▶  $IOV_{DD}$  is referred to DGND. This supply sets the interface logic levels on the SPI and powers an internal regulator for operation of the digital processing.

### Single Supply Operation ( $AV_{SS} = \text{DGND}$ )

When the ADFS7124-8 is powered from a single supply connected to  $AV_{DD}$ ,  $AV_{SS}$  and DGND can be shorted together on one single ground plane. With this setup, an external level shifting circuit is required when using truly bipolar inputs to shift the common-mode voltage. Recommended regulators include the [ADP162](#), which has a low quiescent current.

### Split Supply Operation ( $AV_{SS} \neq \text{DGND}$ )

The ADFS7124-8 can operate with  $AV_{SS}$  set to a negative voltage, allowing true bipolar inputs to be applied. This allows a truly fully differential input signal centered around 0 V to be applied to the ADFS7124-8 without the need for an external level shifting circuit. For example, with a 3.6 V split supply,  $AV_{DD} = +1.8 \text{ V}$  and  $AV_{SS} = -1.8 \text{ V}$ . In this use case, the ADFS7124-8 internally level shifts the signals, allowing the digital output to function between DGND (nominally 0 V) and  $IOV_{DD}$ .

When using a split supply for  $AV_{DD}$  and  $AV_{SS}$ , the absolute maximum ratings must be considered (see the [Absolute Maximum Ratings](#) section). Ensure that  $IOV_{DD}$  is set below 3.6 V to stay within the absolute maximum ratings for the device.

## DIGITAL COMMUNICATION

The ADFS7124-8 has a 3-wire or 4-wire SPI compatible with QSPI, MICROWIRE, and DSPs. The interface operates in SPI Mode 3 and can be operated with  $\overline{\text{CS}}$  tied low. In SPI Mode 3, SCLK idles high, the falling edge of SCLK is the drive edge, and the rising edge of SCLK is the sample edge. This means that data is clocked out on the falling/drive edge and data is clocked in on the rising/sample edge.

GETTING STARTED

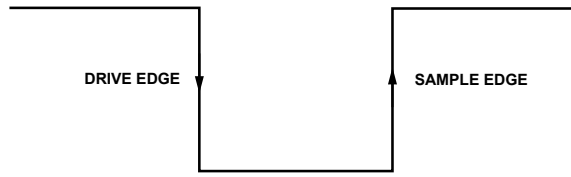

Figure 65. SPI Mode 3, SCLK Edges

Accessing the ADC Register Map

The communications register controls access to the full register map of the ADC. This register is an 8-bit, write only register. On power-up or after a reset, the digital interface defaults to a state where it expects a write to the communications register; therefore, all communication begins by writing to the communications register.

The data written to the communications register determines which register is accessed and if the next operation is a read or write. The register address bits (Bit 5 to Bit 0) determine the specific register to which the read or write operation applies.

When the read or write operation to the selected register is complete, the interface returns to its default state, where it expects a write operation to the communications register.

In situations where interface synchronization is lost, a write operation of at least 64 serial clock cycles with DIN high returns the ADC to its default state by resetting the entire device, including the register contents. Alternatively, if CS is used with the digital interface, returning CS high resets the digital interface to its default state and aborts any current operation.

Figure 66 and Figure 67 illustrate writing to and reading from a register by first writing the 8-bit command to the communications register followed by the data for the addressed register.

Reading the ID register is the recommended method for verifying correct communication with the device. The ID register is a read

only register and contains the value of 0x17 for the ADFS7124-8. The communication register and ID register details are described in Table 37 and Table 38.

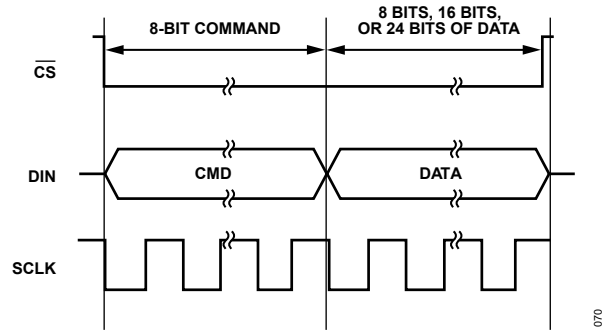

Figure 66. Writing to a Register (8-Bit Command with Register Address Followed by Data of 8 Bits, 16 Bits, or 24 Bits; Data Length Is Dependent on the Register Selected)

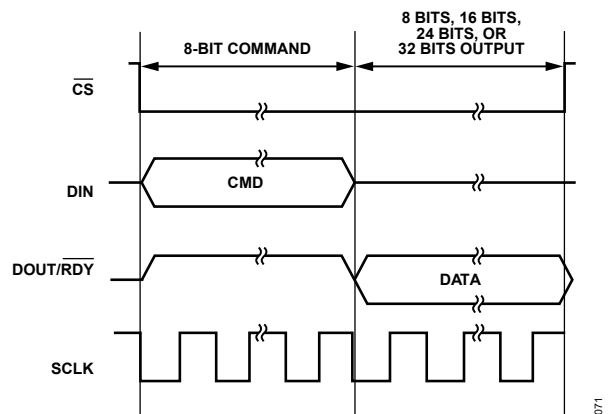

Figure 67. Reading from a Register (8-Bit Command with Register Address Followed by Data of 8 Bits, 16 Bits, 24 Bits, or 32 Bits; Data Length on DOUT Is Dependent on the Register Selected, CRC Enabled)

Table 37. Communications Register

Reg.	Name	Bits	Bit 7	Bit 6	Bit 5	Bit 4	Bit 3	Bit 2	Bit 1	Bit 0	Reset	RW
0x00	COMMS	[7:0]	WEN	R/W			RS[5:0]				0x00	W

Table 38. ID Register

Reg.	Name	Bits	Bit 7	Bit 6	Bit 5	Bit 4	Bit 3	Bit 2	Bit 1	Bit 0	Reset	RW
0x05	ID	[7:0]			DEVICE_ID			SILICON_REVISION			0x17	R

GETTING STARTED

CONFIGURATION OVERVIEW

After power-on or reset, the ADFS7124-8 default configuration is as follows:

- ▶ Channel: Channel 0 is enabled, AIN0 is selected as the positive input, and AIN1 is selected as the negative input. Setup 0 is selected.
- ▶ Setup: the input and reference buffers are disabled, the gain is set to 1, and the external reference is selected.
- ▶ ADC control: the ADFS7124-8 is in the low power mode, continuous conversion mode and the internal oscillator is enabled and selected as the ADC clock source.
- ▶ Diagnostics: the only diagnostic enabled is the SPI\_IGNORE\_ERR function.

Note that only a few of the register setting options are shown; this list is just an example. For full register information, see the [On-Chip Registers](#) section.

Figure 68 shows an overview of the suggested flow for changing the ADC configuration, divided into the following blocks:

- ▶ Channel configuration (see Box A in Figure 68 )
- ▶ Setup (see Box B in Figure 68 )
- ▶ Diagnostics (see Box C in Figure 68 )
- ▶ ADC control (see Box D in Figure 68 )

Channel Configuration

The ADFS7124-8 has 16 independent analog input channels and eight independent setups. The user can select any of the analog input pairs on any channel, as well as any of the eight setups for any channel, giving the user full flexibility in the channel configuration. This also allows per channel configuration when using all differential inputs because each channel can have its own dedicated setup.

Along with the analog inputs, signals such as the power supply or reference can also be used as inputs; they are routed to the multiplexer internally when selected. The ADFS7124-8 allows the user to define 16 configurations, or channels, to the ADC. This allows diagnostics to be interleaved with conversions.

Channel Registers

Use the channel registers to select which input pins are either the positive analog input or the negative analog input for that channel. This register also contains a channel enable/disable bit and the setup selection bits, which are used to select the eight available setups to use for this channel.

When the ADFS7124-8 is operating with more than one channel enabled, the channel sequencer cycles through the enabled channels in sequential order, from Channel 0 to Channel 15. If a channel is disabled, it is skipped by the sequencer. Details of the channel register for Channel 0 are shown in Table 39.

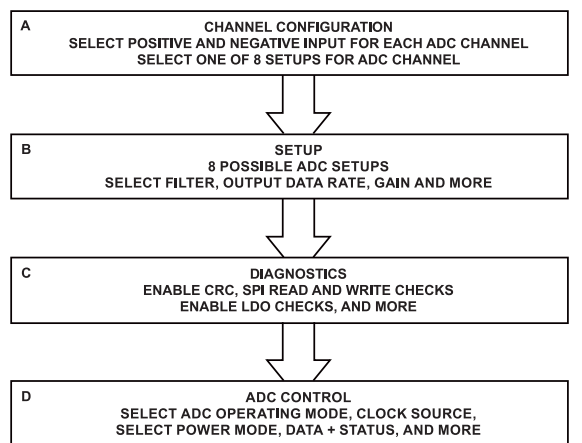

Figure 68. Suggested ADC Configuration Flow

Table 39. Channel 0 Register

Reg.	Name	Bits	Bit 7	Bit 6	Bit 5	Bit 4	Bit 3	Bit 2	Bit 1	Bit 0	Reset	RW
0x09	CHANNEL_0	[15:8] [7:0]	Enable		Setup AINP[2:0]			0		AINP[4:3] AINM[4:0]	0x8001	RW



GETTING STARTED

ADC Setups

The ADFS7124-8 has eight independent setups. Each setup consists of the following four registers:

- ▶ Configuration register
- ▶ Filter register
- ▶ Offset register
- ▶ Gain register

For example, Setup 0 consists of Configuration Register 0, Filter Register 0, Offset Register 0, and Gain Register 0. The setup is selectable from the channel registers detailed in the [Channel Configuration](#) section. This allows each channel to be assigned to one of eight separate setups.

Configuration Registers

The configuration registers allow the user to select the output coding of the ADC by selecting between bipolar and unipolar. In bipolar mode, the ADC accepts negative differential input voltages, and the output coding is offset binary. In unipolar mode, the ADC accepts only positive differential voltages, and the coding is straight binary. In either case, the input voltage must be within the  $AV_{DD}$  and  $AV_{SS}$  supply voltages. The user can also select the reference source using these registers. Four options are available: an internal 2.5 V reference, an external reference connected between REFIN1(+) and REFIN1(-), an external reference connected between REFIN2(+) and REFIN2(-), or  $AV_{DD}$  to  $AV_{SS}$ . The PGA gain is also

set; gains of 1, 2, 4, 8, 16, 32, 64, and 128 are provided. The analog input buffers and reference input buffers for the setup can also be enabled using this register.

Filter Registers

The filter registers select which digital filter is used at the output of the ADC modulator. The filter type and the output data rate are selected by setting the bits in this register. For more information, see the [Digital Filter](#) section.

Offset Registers

The offset registers hold the offset calibration coefficient for the ADC. The power-on reset value of an offset register is 0x800000. The offset registers are 24-bit read/write registers. The power-on reset value is automatically overwritten if an internal or system zero-scale calibration is initiated by the user or if the offset registers are written to by the user.

Gain Registers

The gain registers are 24-bit registers that hold the gain calibration coefficient for the ADC. The gain registers are read/write registers. The gain is factory calibrated at a gain of 1; thus, the default value varies from device to device. The default value is automatically overwritten if an internal or system full-scale calibration is initiated by the user. For more information on calibration, see the [Calibration](#) section.

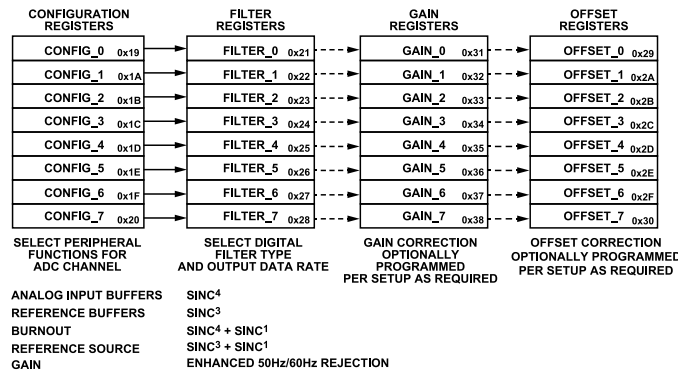

Figure 69. ADC Setup Register Grouping



## GETTING STARTED

Table 40. Configuration 0 Register

Reg.	Name	Bits	Bit 7	Bit 6	Bit 5	Bit 4	Bit 3	Bit 2	Bit 1	Bit 0	Reset	RW
0x19	CONFIG_0	[15:8]	0				Bipolar	Burnout		REF_BUFP	0x0860	RW
		[7:0]	REF_BUFM	AIN_BUFP	AIN_BUFM	REF_SEL	PGA					

Table 41. Filter 0 Register

Reg.	Name	Bits	Bit 7	Bit 6	Bit 5	Bit 4	Bit 3	Bit 2	Bit 1	Bit 0	Reset	RW
0x28	FILTER_0	[23:9]	Filter			REJ60	POST_FILTER		SINGLE_CYCLE		0x060180	RW
		[15:8]	0				FS[10:8]					
		[7:0]	FS[7:0]									

Table 42. Offset 0 Register

Reg.	Name	Bits	Bits[23:0]	Reset	RW
0x29	OFFSET_0	[23:0]	Offset[23:0]	0x800000	RW

Table 43. Gain 0 Register

Reg.	Name	Bits	Bits[23:0]	Reset	RW
0x31	GAIN_0	[23:0]	Gain[23:0]	0x5XXXXX	RW

## GETTING STARTED

### Diagnostics

The ERROR\_EN register enables and disables the numerous diagnostics on the ADFS7124-8. By default, the SPI\_IGNORE function is enabled, which indicates inappropriate times to write to the ADC (for example, during power-up and during a reset). Other diagnostics include:

- ▶ SPI read and write checks, which ensure that only valid registers are accessed.
- ▶ SCLK counter, which ensures that the correct number of SCLK pulses are used.
- ▶ SPI CRC
- ▶ Memory map CRC
- ▶ LDO checks

When a diagnostic is enabled, the corresponding flag is contained in the error register. All enabled flags are OR'ed to control the ERR flag in the status register. Thus, if an error occurs (for example, the SPI CRC check detects an error), the relevant flag (for example, the SPI\_CRC\_ERR flag) in the error register is set. The ERR flag in the status register is also set. This is useful when the status bits are appended to conversions. The ERR bit indicates if an error occurred. Then read the error register for more details on the error source.

The frequency of the on-chip oscillator can also be monitored on the ADFS7124-8. The MCLK\_COUNT register monitors the master clock pulses. [Table 44](#) to [Table 46](#) give more details on the diagnostic registers. See the [Diagnostics](#) section for more details on the diagnostics available.

### ADC Control Register

The ADC control register configures the core peripherals for use by the ADFS7124-8 and the mode for the digital interface. The power mode (full power, mid power, or low power) is selected through this register. Also, the mode of operation is selected, for example, continuous conversion or single conversion. The user can also select the standby and power-down modes, as well as any of the calibration modes. In addition, this register contains the clock source select bits and internal reference enable bits. The reference select bits are contained in the setup configuration registers (see the [ADC Setups](#) section for more information).

The digital interface operation is also selected through the ADC control register. This register allows the user to enable the data plus status read and continuous read mode. For more details, see the [Digital Interface](#) section. The details of this register are shown in [Table 47](#).

## GETTING STARTED

Table 44. Error Register

Reg.	Name	Bits	Bit 7	Bit 6	Bit 5	Bit 4	Bit 3	Bit 2	Bit 1	Bit 0	Reset	RW
0x06	Error	[23:16]	0				LDO_CAP_	ADC_CAL_	ADC_CONV_	ADC_SAT_	0x000000	R
						ERR	ERR	ERR	ERR			
		[15:8]	AINP_OV_	AINP_UV_	AINM_OV_	AINM_	REF_DET_	0	DLDO_PSM_	0		
		[7:0]	ALDO_PSM_	SPI_IGNORE_	SPI_SCLK_	SPI_	SPI_WRITE_	SPI_CRC_	MM_CRC_	ROM_CRC_		
			ERR	_ERR	CNT_ERR	READ_	ERR	ERR	ERR	ERR		
						ERR						

Table 45. Error Enable Register

Reg.	Name	Bits	Bit 7	Bit 6	Bit 5	Bit 4	Bit 3	Bit 2	Bit 1	Bit 0	Reset	RW
0x07	ERROR_	[23:16]	0	MCLK_CNT_	LDO_CAP_	LDO_CAP_CHK		ADC_CAL_	ADC_CONV_	ADC_SAT_	0x000040	RW
				EN	CHK_TEST_			ERR_EN	ERR_EN	ERR_EN		
		[15:8]	AINP_OV_	AINP_UV_	AINM_OV_	AINM_UV_	REF_DET_	DLDO_PSM_	DLDO_PSM_	ALDO_PSM_		
		[7:0]	ALDO_	SPI_	SPI_SCLK_	SPI_	SPI_	SPI_CRC_	MM_CRC_	ROM_CRC_		
			PSM_	IGNORE_	CNT_ERR_	READ_	WRITE_	ERR_EN	ERR_EN	ERR_EN		
			ERR_EN	ERR_EN	EN	ERR_EN	ERR_EN					

Table 46. MCLK Count Register

Reg.	Name	Bits	Bit 7	Bit 6	Bit 5	Bit 4	Bit 3	Bit 2	Bit 1	Bit 0	Reset	RW
0x08	MCLK_COUNT	[7:0]	MCLK_COUNT								0x00	R

Table 47. ADC Control Register

Reg.	Name	Bits	Bit 7	Bit 6	Bit 5	Bit 4	Bit 3	Bit 2	Bit 1	Bit 0	Reset	RW
0x01	ADC_CONTROL	[15:8]	0			DOUT_RDY_DEL	CONT_READ	DATA_STATUS	$\overline{\text{CS}}_EN$	REF_EN	0x0000	RW
		[7:0]	POWER_MODE		Mode				CLK_SEL			

GETTING STARTED

Understanding Configuration Flexibility

In Figure 70, Figure 71, and Figure 72, the registers shown in black font are programmed for this configuration. The registers shown in gray font are redundant.

The most straightforward implementation of the ADFS7124-8 is to use differential inputs with adjacent analog inputs and run all of them with the same setup, gain correction, and offset correction register. For example, for four differential inputs, select the following differential inputs: AIN0/AIN1, AIN2/AIN3, AIN4/AIN5, and AIN6/AIN7.

Programming the gain and offset registers is optional for any use case, as indicated by the dashed lines between the register blocks.

If an internal or system offset or full-scale calibration is performed, the gain and offset registers for the selected channel are automatically updated.

An alternative way to implement these four fully differential inputs is by taking advantage of the eight available setups. Motivation for this includes having a different speed, noise, or gain requirement on some of the four differential inputs vs. other inputs, or there may be a specific offset or gain correction for particular channels. Figure 71 shows how each of the differential inputs can use a separate setup, allowing full flexibility in the configuration of each channel.

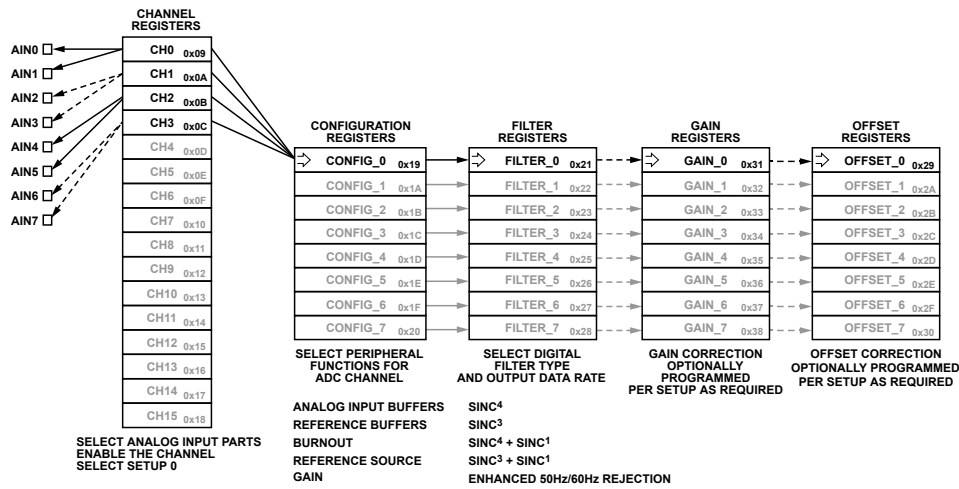

Figure 70. Four Fully Differential Inputs, All Using a Single Setup (CONFIG\_0, FILTER\_0, GAIN\_0, OFFSET\_0)

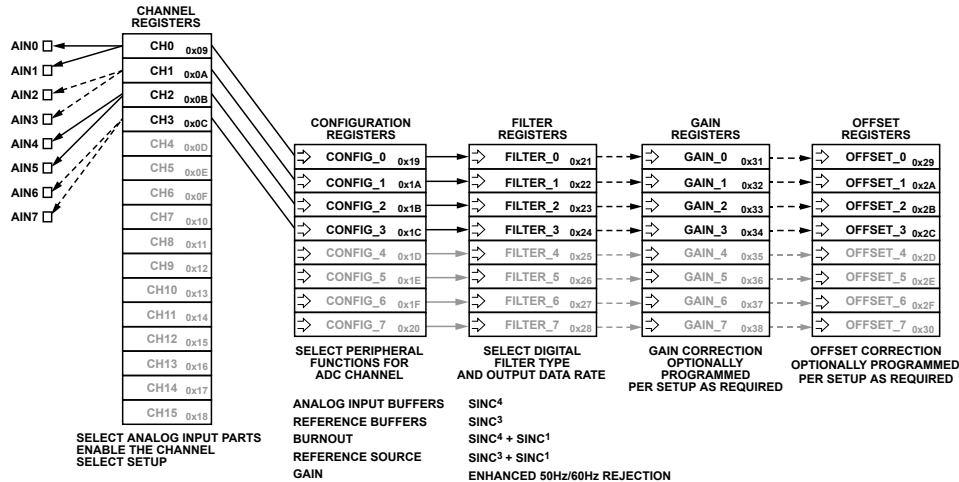

Figure 71. Four Fully Differential Inputs with a Separate Setup per Channel

GETTING STARTED

Figure 72 shows an example of how the channel registers span between the analog input pins and setup configurations downstream. In this random example, two differential inputs and two single-ended inputs are required. The single-ended inputs are the AIN0/AIN7 and AIN6/AIN7 combinations. The first differential input pair (AIN0/AIN1) uses Setup 0. The two single-ended input pairs (AIN0/AIN7 and AIN6/AIN7) are set up as diagnostics; therefore, they use a separate setup (Setup 1). The final differential input (AIN2/AIN3) also uses a separate setup: Setup 2.

Given that three setups are selected for use, the CONFIG\_0, CONFIG\_1, and CONFIG\_2 registers are programmed as required, and the FILTER\_0, FILTER\_1, and FILTER\_2 registers are also

programmed as required. Optional gain and offset correction can be employed on a per setup basis by programming the GAIN\_0, GAIN\_1, and GAIN\_2 registers, and the OFFSET\_0, OFFSET\_1, and OFFSET\_2 registers.

In the example shown in Figure 72, the CHANNEL\_0 to CHANNEL\_3 registers are used. Setting the MSB (the enable bit) in each of these registers enables the four combinations through the cross-point multiplexer. When the ADFS7124-8 converts, the sequencer transitions in ascending sequential order from CHANNEL\_0 to CHANNEL\_1 to CHANNEL\_2, and then on to CHANNEL\_3 before looping back to CHANNEL\_0 to repeat the sequence.

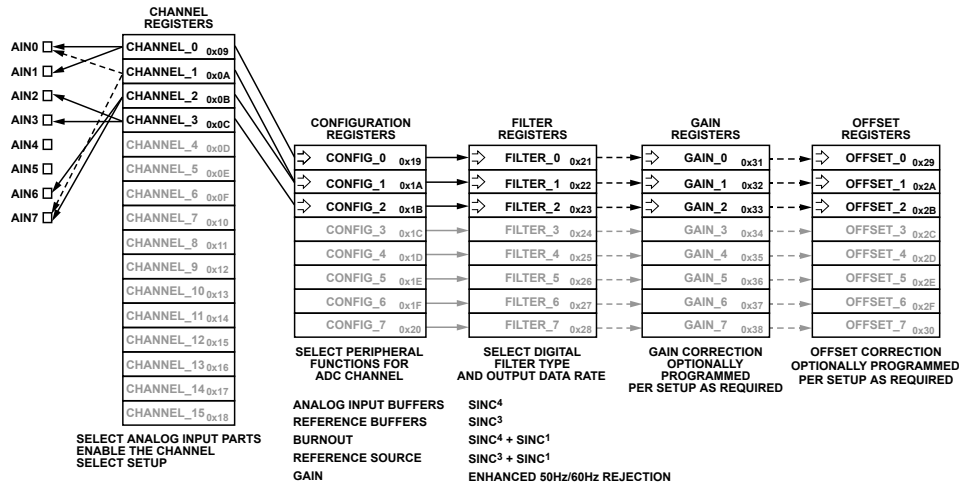

Figure 72. Mixed Differential and Single-Ended Configuration Using Multiple Shared Setups

ADC CIRCUIT INFORMATION

ANALOG INPUT CHANNEL

The uses flexible multiplexing; thus, any of the analog input pins, AIN0 to AIN15, can be selected as a positive or negative input. This feature allows the user to perform diagnostics such as checking that pins are connected. It also simplifies printed circuit board (PCB) design. For example, the same PCB can accommodate 2-wire, 3-wire, and 4-wire resistance temperature detectors (RTDs).

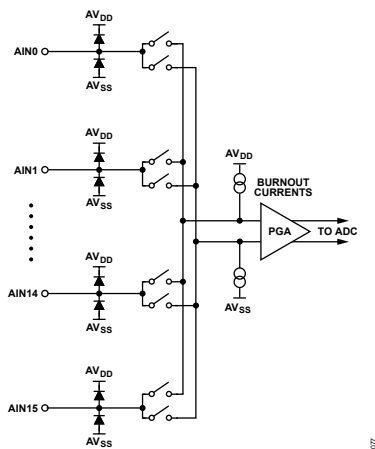

Figure 73. Analog Input Multiplexer Circuit

The channels are configured using the AINP[4:0] bits and the AINM[4:0] bits in the channel registers (see Table 48). The device can be configured to have 8 differential inputs, 15 pseudo differential inputs, or a combination of both. When using differential

Table 48. Channel Register

Reg.	Name	Bits	Bit 7	Bit 6	Bit 5	Bit 4	Bit 3	Bit 2	Bit 1	Bit 0	Reset	RW
0x09 to 0x18	CHANNEL_0 to CHANNEL_15	[15:8] [7:0]	Enable	Setup				0	AINP[4:3]		0x8001	RW
				AINP[2:0]				AINM[4:0]				

Table 49. Configuration Register

Reg.	Name	Bits	Bit 7	Bit 6	Bit 5	Bit 4	Bit 3	Bit 2	Bit 1	Bit 0	Reset	RW
0x19 to 0x20	CONFIG_0 to CONFIG_7	[15:8] [7:0]			0		Bipolar	Burnout	REF_BUFP		0x0860	RW
			REF_BUFM	AIN_BUFP	AIN_BUFM	REF_SEL		PGA				

inputs, use adjacent analog input pins to form the input pair. Using adjacent pins minimizes any mismatch between the channels.

The inputs can be buffered or unbuffered at a gain of 1 but are automatically buffered when the gain exceeds 1. The AINP and AINM buffers are enabled/disabled separately using the AIN\_BUFPM and AIN\_BUFM bits in the configuration register (see Table 49). In buffered mode, the input channel feeds into a high impedance input stage of the buffer amplifier. Therefore, the input can tolerate significant source impedances and is tailored for direct connection to external resistive type sensors such as strain gages or RTDs.

When the device is operated in unbuffered mode, the device has a higher analog input current. Note that this unbuffered input path provides a dynamic load to the driving source. Therefore, resistor/capacitor (RC) combinations on the input pins can cause gain errors, depending on the output impedance of the source driving the ADC input.

The absolute input voltage in unbuffered mode (gain = 1) includes the range between  $AV_{SS} - 50\text{ mV}$  and  $AV_{DD} + 50\text{ mV}$ . The absolute input voltage range in buffered mode at a gain of 1 is restricted to a range between  $AV_{SS} + 100\text{ mV}$  and  $AV_{DD} - 100\text{ mV}$ . The common-mode voltage must not exceed these limits; otherwise, linearity and noise performance degrade.

When the gain is greater than 1, the analog input buffers are automatically enabled. The PGA placed in front of the input buffers is rail-to-rail; thus, in this case, the absolute input voltage includes the range from  $AV_{SS} - 50\text{ mV}$  to  $AV_{DD} + 50\text{ mV}$ .

## ADC CIRCUIT INFORMATION

### PROGRAMMABLE GAIN AMPLIFIER (PGA)

When the gain stage is enabled, the output from the multiplexer is applied to the input of the PGA. The presence of the PGA means that signals of small amplitude can be gained within the ADFS7124-8 and still maintain excellent noise performance.

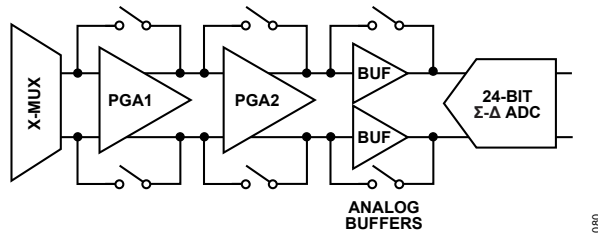

Figure 74. Programmable Gain Amplifier (PGA)

The ADFS7124-8 can be programmed to have a gain of 1, 2, 4, 8, 16, 32, 64, or 128 by using the PGA bits in the configuration register (see Table 49). The PGA consists of two stages. For a gain of 1, both stages are bypassed. For gains of 2 to 8, a single stage is used, whereas for gains greater than 8, both stages are used.

The analog input range is  $\pm V_{REF}/\text{gain}$ . Therefore, with an external 2.5 V reference, the unipolar ranges are from 0 mV to 19.53 mV to 0 V to 2.5 V, and the bipolar ranges are from  $\pm 19.53$  mV to  $\pm 2.5$  V. For high reference values, for example,  $V_{REF} = AV_{DD}$ , the analog input range must be limited. Consult the Specifications section for more details on these limits.

### REFERENCE

The ADFS7124-8 has an embedded 2.5 V reference. The embedded reference is a low noise, low drift reference with 15 ppm/ $^{\circ}\text{C}$  drift maximum. Including the reference on the ADFS7124-8 reduces the number of external components needed in applications such as thermocouples, leading to a reduced PCB size.

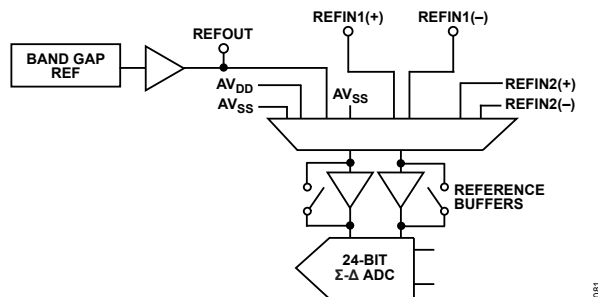

Figure 75. Reference Connections

This reference can be used to supply the ADC (by setting the REF\_EN bit in the ADC\_CONTROL register to 1) or an external reference can be applied. For external references, the ADC has a fully differential input capability for the channel. In addition, the user can select one of two external reference options (REFIN1 or REFIN2). The reference source for the ADFS7124-8 is selected using the REF\_SEL bits in the configuration register (see Table 49).

When the internal reference is selected, it is internally connected to the modulator. It can also be made available on the REFOUT pin. A 0.1  $\mu\text{F}$  decoupling capacitor is required on REFOUT when the internal reference is active.

The common-mode range for the differential reference inputs is from  $AV_{SS} - 50$  mV to  $AV_{DD} + 50$  mV when the reference buffers are disabled. The reference inputs can also be buffered on-chip. The buffers require 100 mV of headroom. The reference voltage of REFIN (REFINx(+)) - REFINx(-)) is 2.5 V nominal, but the ADFS7124-8 is functional with reference voltages from 0.5 V to  $AV_{DD}$ .

In applications where the excitation (voltage or current) for the transducer on the analog input also drives the reference voltage for the devices, the effect of the low frequency noise in the excitation source is removed, because the application is ratiometric. If the ADFS7124-8 is used in nonratiometric applications, use a low noise reference.

The recommended 2.5 V reference voltage sources for the ADFS7124-8 include the ADR4525, which is a low noise, low power reference. Note that the reference input provides a high impedance, dynamic load when unbuffered. Because the input impedance of each reference input is dynamic, resistor/capacitor combinations on these inputs can cause DC gain errors if the reference inputs are unbuffered, depending on the output impedance of the source driving the reference inputs.

Reference voltage sources typically have low output impedances and are, therefore, tolerant to having decoupling capacitors on REFINx(+) without introducing gain errors in the system. Deriving the reference input voltage across an external resistor means that the reference input sees a significant external source impedance. In this situation, using the reference buffers is required.

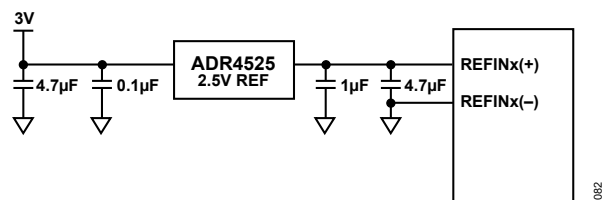

Figure 76. ADR4525 to ADFS7124-8 Connections

### BIPOLAR/UNIPOLAR CONFIGURATION

The analog input to the ADFS7124-8 can accept either unipolar or bipolar input voltage ranges, which allows the user to tune the ADC input range to the sensor output range. When a split power supply is used, the device accepts truly bipolar inputs. When a single power supply is used, a bipolar input range does not imply that the device can tolerate negative voltages with respect to system  $AV_{SS}$ . Unipolar and bipolar signals on the AINP input are referenced to the voltage on the AINM input. For example, if AINM is 1.5 V and the ADC is configured for unipolar mode with a gain of 1, the input voltage range on the AINP input is 1.5 V to 3 V when  $V_{REF} =$

**ADC CIRCUIT INFORMATION**

$AV_{DD} = 3\text{ V}$ . If the ADC is configured for bipolar mode, the analog input range on the AINP input is 0 V to  $AV_{DD}$ . The bipolar/unipolar option is chosen by programming the bipolar bit in the configuration register.

**DATA OUTPUT CODING**

When the ADC is configured for unipolar operation, the output code is natural (straight) binary with a zero differential input voltage resulting in a code of 00 ... 00, a midscale voltage resulting in a code of 100 ... 000, and a full-scale input voltage resulting in a code of 111 ... 111. The output code for any analog input voltage can be represented as

$$Code = (2^N \times A_{IN} \times Gain) / V_{REF}$$

When the ADC is configured for bipolar operation, the output code is offset binary with a negative full-scale voltage resulting in a code of 000 ... 000, a zero differential input voltage resulting in a code of 100 ... 000, and a positive full-scale input voltage resulting in a code of 111 ... 111. The output code for any analog input voltage can be represented as

$$Code = 2^{N-1} \times [(A_{IN} \times Gain / V_{REF}) + 1]$$

where:

$N = 24$ .

$A_{IN}$  is the analog input voltage.

$Gain$  is the gain setting (1 to 128).

**EXCITATION CURRENTS**

The ADFS7124-8 also contains two matched, software configurable, constant current sources that can be programmed to equal 0.1  $\mu\text{A}$ , 50  $\mu\text{A}$ , 100  $\mu\text{A}$ , 250  $\mu\text{A}$ , 500  $\mu\text{A}$ , 750  $\mu\text{A}$ , or 1 mA. These current sources can be used to excite external resistive bridges or RTD sensors. Both current sources source currents from  $AV_{DD}$  and can be directed to any of the analog input pins (see Figure 77).

The pins on which the currents are made available are programmed using the IOUT1\_CH and IOUT0\_CH bits in the IO\_CONTROL\_1 register (see Table 50). The magnitude of each current source is individually programmable using the IOUT1 and IOUT0 bits in the IO\_CONTROL\_1 register. In addition, both currents can be output to the same analog input pin.

**Table 50. Input/Output Control 1 Register**

Reg.	Name	Bits	Bit 7	Bit 6	Bit 5	Bit 4	Bit 3	Bit 2	Bit 1	Bit 0	Reset	RW
0x03	IO_CONTROL_1	[23:16]	GPIO_DAT4	GPIO_DAT3	GPIO_DAT2	GPIO_DAT1	GPIO_CTRL 4	GPIO_CTRL 3	GPIO_CTRL 2	GPIO_CTRL 1	0x000000	RW
[15:8]		PDSW	0	IOUT1		IOUT0						
[7:0]		IOUT1_CH				IOUT0_CH						

Note that the on-chip reference does not need to be enabled when using the excitation currents.

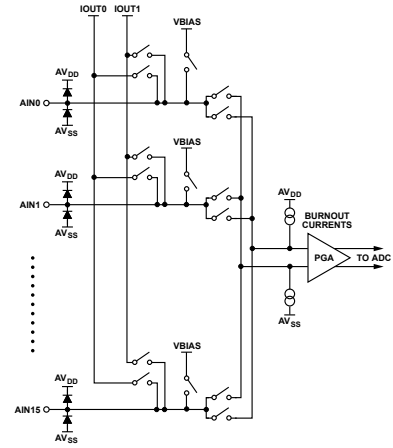

**Figure 77. Excitation Current and Bias Voltage Connections**

**BRIDGE POWER-DOWN SWITCH**

In bridge applications such as strain gages and load cells, the bridge itself consumes the majority of the current in the system. For example, a 350  $\Omega$  load cell requires 8.6 mA of current when excited with a 3 V supply. To minimize the current consumption of the system, the bridge can be disconnected (when it is not being used) using the bridge power-down switch. The switch can withstand 30 mA of continuous current, and it has an on-resistance of 10  $\Omega$  maximum. The PDSW bit in the IO\_CONTROL\_1 register controls the switch.

**LOGIC OUTPUTS**

The ADFS7124-8 has four general-purpose digital outputs: P1 to P4. These are enabled using the GPIO\_CTRL bits in the IO\_CONTROL\_1 register (see Table 50). The pins can be pulled high or low using the GPIO\_DATx bits in the register; that is, the value at the pin is determined by the setting of the GPIO\_DATx bits. The logic levels for these pins are determined by  $AV_{DD}$  rather than by  $IOV_{DD}$ .



## ADC CIRCUIT INFORMATION

These pins can be used to drive external circuitry, for example, an external multiplexer. If an external multiplexer is used to increase the channel count, the multiplexer logic pins can be controlled through the ADFS7124-8 general-purpose output pins. The general-purpose output pins can be used to select the active multiplexer pin. Because the operation of the multiplexer is independent of the ADFS7124-8, reset the modulator and filter using the SYNC pin or by writing to the mode or configuration register each time that the multiplexer channel is changed.

### BIAS VOLTAGE GENERATOR

A bias voltage generator is included on the ADFS7124-8 (see Figure 77). It biases the negative terminal of the selected input channel to  $(AV_{DD} - AV_{SS})/2$ . This function is useful in thermocouple applications, as the voltage generated by the thermocouple must be biased around some DC voltage if the ADC operates from a single power supply. The bias voltage generator is controlled using the VBIASx bits in the IO\_CONTROL\_2 register (see Table 52). The power-up time of the bias voltage generator is dependent on the load capacitance. Consult the Specifications section for more details.

### CLOCK

The ADFS7124-8 includes an internal 614.4 kHz clock on chip. This internal clock has a tolerance of  $\pm 5\%$ . Use either the internal clock or an external clock as the clock source to the ADFS7124-8. The clock source is selected using the CLK\_SEL bits in the ADC\_CONTROL register (see Table 53).

The internal clock can also be made available at the CLK pin. This is useful when several ADCs are used in an application and the devices must be synchronized. The internal clock from one device can be used as the clock source for all ADCs in the system. Using a common clock, the devices can be synchronized by applying a common reset to all devices, or the SYNC pin can be pulsed.

### POWER MODES

The ADFS7124-8 has three power modes: full power mode, mid power mode, and low power mode. The mode is selected using the POWER\_MODE bits in the ADC\_CONTROL register. The power mode affects the power consumption of the device as well as changing the controller clock frequency. A 614.4 kHz clock is used

by the device. However, this clock is internally divided, the division factor being dependent on the power mode. Thus, the range of output data rates and performance is affected by the power mode.

Table 51. Power Modes

Power Mode	Controller Clock (kHz)	Output Data Rate <sup>1</sup> (SPS)	Current
Full Power	614.4	9.37 to 19,200	See the Specifications section
Mid Power	153.6	2.34 to 4800	
Low Power	76.8	1.17 to 2400	

<sup>1</sup> Unsettled, using a  $\text{sinc}^3/\text{sinc}^4$  filter.

### STANDBY AND POWER-DOWN MODES

In the standby mode, most blocks are powered down. The LDOs remain active so that registers maintain their contents. If enabled, the reference, internal oscillator, digital outputs P1 to P4, bias voltage generator, and low-side power switch remain active. The excitation currents, if enabled, also remain active in the standby mode. These blocks can be disabled, if required, by setting the corresponding bits appropriately. The reference detection and LDO capacitor detection functions are disabled in the standby mode.

Other diagnostics remain active if enabled when the ADC is in the standby mode. Diagnostics can be enabled or disabled while in the standby mode. However, any diagnostics that require the controller clock (reference detect, undervoltage/overvoltage detection, LDO trip tests, memory map CRC, and MCLK counter) must be enabled when the ADC is in the continuous conversion mode or idle mode; these diagnostics do not function if enabled in the standby mode.

The standby current is typically 15  $\mu\text{A}$  when the LDOs only are enabled. If functions such as the bias voltage generator remain active in the standby mode, the current increases by 36  $\mu\text{A}$  typically. If the internal oscillator remains active in the standby mode, the current increases by 22  $\mu\text{A}$  typically. When exiting the standby mode, the ADFS7124-8 requires 130 MCLK cycles to power up and settle. The internal oscillator, if disabled in the standby mode, requires an additional 40  $\mu\text{s}$  to power up and settle. If an external controller clock is being used, ensure that it is active before issuing the command to exit the standby mode. Do not write to the ADC\_CONTROL register again until the ADC has powered up and settled.

Table 52. Input/Output Control 2 Register

Reg.	Name	Bit 7	Bit 6	Bit 5	Bit 4	Bit 3	Bit 2	Bit 1	Bit 0	Reset	RW
0x04	IO_CONTROL_2	VBIAS15	VBIAS14	VBIAS13	VBIAS12	VBIAS11	VBIAS10	VBIAS9	VBIAS8	0x0000	RW
		VBIAS7	VBIAS6	VBIAS5	VBIAS4	VBIAS3	VBIAS2	VBIAS1	VBIAS0		

Table 53. ADC Control Register

Reg.	Name	Bit 7	Bit 6	Bit 5	Bit 4	Bit 3	Bit 2	Bit 1	Bit 0	Reset	RW
0x01	ADC_CONTROL	0			DOUT_RDY_DEL	CONT_READ	DATA_STATUS	CS_EN	REF_EN	0x0000	RW
		POWER_MODE		Mode			CLK_SEL				

## ADC CIRCUIT INFORMATION

In the power-down mode, all blocks are powered down, including the LDOs. All registers lose their contents, and the digital outputs P1 to P4 are placed in tristate. To prevent accidental entry to the power-down mode, the ADC must first be placed into the standby mode. If an external controller clock is being used, keep it active until the device is placed in the power-down mode. Exiting the power-down mode requires 64 SCLK cycles with  $\overline{CS} = 0$  and  $DIN = 1$ , that is, a serial interface reset. The ADFS7124-8 requires 2 ms typically to power up and settle. After this time, the user can access the on-chip registers. The power-down current is 2  $\mu$ A typically.

### DIGITAL INTERFACE

The programmable functions of the ADFS7124-8 are controlled using a set of on-chip registers. Data is written to these registers through the serial interface. Read access to the on-chip registers is also provided by this interface. All communications with the device must start with a write to the communications register. After power-on or reset, the device expects a write to its communications register. The data written to this register determines whether the next operation is a read operation or a write operation, and determines to which register this read or write operation occurs. Therefore, write access to any of the other registers on the devices begins with a write operation to the communications register, followed by a write to the selected register. A read operation from any other register (except when continuous read mode is selected) starts with a write to the communications register, followed by a read operation from the selected register.

The serial interface of the ADFS7124-8 consists of four signals:  $\overline{CS}$ , DIN, SCLK, and DOUT/RDY. The DIN line transfers data into the on-chip registers, whereas DOUT/RDY accesses data from the on-chip registers. SCLK is the serial clock input for the device, and all data transfers (either on DIN or DOUT/RDY) occur with respect to the SCLK signal. The DOUT/RDY pin also operates as a data ready signal; the line goes low when a new data-word is available in the output register. It is reset high when a read operation from the data register is complete. It also goes high before the data register updates to indicate when not to read from the device, to ensure that a data read is not attempted while the register is being updated.  $\overline{CS}$  is used to select a device. It can decode the ADFS7124-8 in systems where several components are connected to the serial bus.

Figure 3 and Figure 4 show timing diagrams for interfacing to the ADFS7124-8 with  $\overline{CS}$  decoding the devices. Figure 3 shows the timing for a read operation from the output shift register of the ADFS7124-8. Figure 4 shows the timing for a write operation to the input shift register. A delay is required between consecutive SPI communications. Figure 5 shows the delay required between SPI read/write operations. It is possible to read the same word from the data register several times, even though the DOUT/RDY line returns high after the first read operation. However, care must be taken to ensure that the read operations are complete before the next output update occurs. In the continuous read mode, the data register can be read only once.

The serial interface can operate in the 3-wire mode by tying  $\overline{CS}$  low. In this case, the SCLK, DIN, and DOUT/RDY lines communicate with the ADFS7124-8. The end of the conversion can be monitored using the RDY bit in the status register. This scheme is suitable for interfacing to microcontrollers. If  $\overline{CS}$  is required as a decoding signal, it can be generated from a port pin. For microcontroller interfaces, it is recommended that SCLK is idle high between data transfers.

The ADFS7124-8 can be operated with  $\overline{CS}$  being used as a frame synchronization signal. This scheme is useful for digital signal processing (DSP) interfaces. In this case, the first bit (MSB) is effectively clocked out by  $\overline{CS}$ , because  $\overline{CS}$  normally occurs after the falling edge of SCLK in DSPs. SCLK can continue to run between data transfers, provided the timing numbers are obeyed.

$\overline{CS}$  must be used to frame read and write operations and the  $\overline{CS\_EN}$  bit in the ADC\_CONTROL register must be set when the diagnostics SPI\_READ\_ERR, SPI\_WRITE\_ERR, or SPI\_SCLK\_CNT\_ERR are enabled.

The serial interface can be reset by writing a series of 1s on the DIN input. See the Reset section for more details. Reset returns the interface to the state in which it is expecting a write to the communications register.

The ADFS7124-8 can be configured to continuously convert or perform a single conversion (see Figure 78 through Figure 80).

### Single Conversion Mode

In the single conversion mode, the ADFS7124-8 performs a single conversion and is placed in the standby mode after the conversion is complete. If a controller clock is present (external controller clock or the internal oscillator is enabled), DOUT/RDY goes low to indicate the completion of a conversion. When the data-word is read from the data register, DOUT/RDY goes high. The data register can be read several times, if required, even when DOUT/RDY is high. Do not read the ADC\_CONTROL register close to the completion of a conversion because the mode bits are being updated by the ADC to indicate that the ADC is in the standby mode.

If several channels are enabled, the ADC automatically sequences through the enabled channels and performs a conversion on each channel. When a conversion is started, DOUT/RDY goes high and remains high until a valid conversion is available and  $\overline{CS}$  is low. As soon as the conversion is available, DOUT/RDY goes low. The ADC then selects the next channel and begins a conversion. Read the present conversion while the next conversion is being performed. As soon as the next conversion is complete, the data register is updated; therefore, there is a limited period in which to read the conversion. When the ADC has performed a single conversion on each of the selected channels, it returns to the standby mode.

If the DATA\_STATUS bit in the ADC\_CONTROL register is set to 1, the contents of the status register are output along with

**ADC CIRCUIT INFORMATION**

the conversion each time that the data read is performed. The four LSBs of the status register indicate the channel to which the conversion corresponds.

**Continuous Conversion Mode**

Continuous conversion is the default power-up mode. The ADFS7124-8 converts continuously, and the  $\overline{RDY}$  bit in the status register goes low each time a conversion is complete. If  $\overline{CS}$  is low, the  $\overline{DOUT}/\overline{RDY}$  line also goes low when a conversion is complete. To read a conversion, write to the communications register, indicating that the next operation is a read of the data register. When the data-word is read from the data register,  $\overline{DOUT}/\overline{RDY}$  goes high. Read this register additional times, if required. However, ensure that the data register is not being accessed at the completion of the next conversion; otherwise the new conversion word is lost.

When several channels are enabled, the ADC automatically sequences through the enabled channels, performing one conversion on each channel. When all channels are converted, the sequence starts again with the first channel. The channels are converted in order from the lowest enabled channel to the highest enabled channel. The data register is updated as soon as each conversion is available. The  $\overline{DOUT}/\overline{RDY}$  pin pulses low each time a conversion is available. Then read the conversion while the ADC converts the next enabled channel.

If the `DATA_STATUS` bit in the `ADC_CONTROL` register is set to 1, the contents of the status register, along with the conversion data, are output each time the data register is read. The status register indicates the channel to which the conversion corresponds.

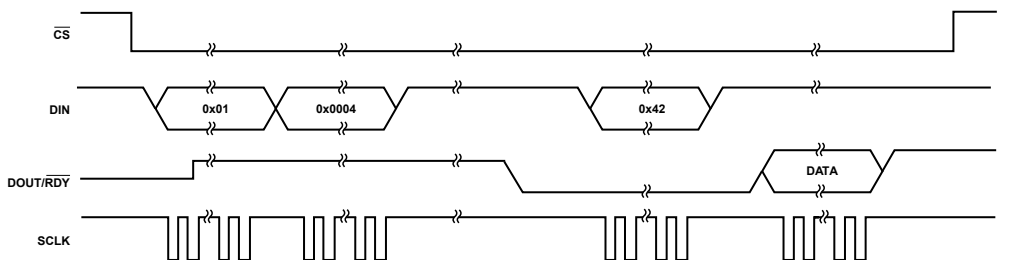

Figure 78. Single Conversion Configuration

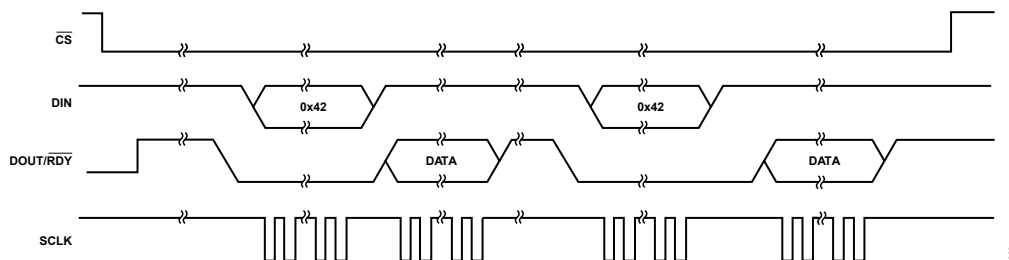

Figure 79. Continuous Conversion Configuration

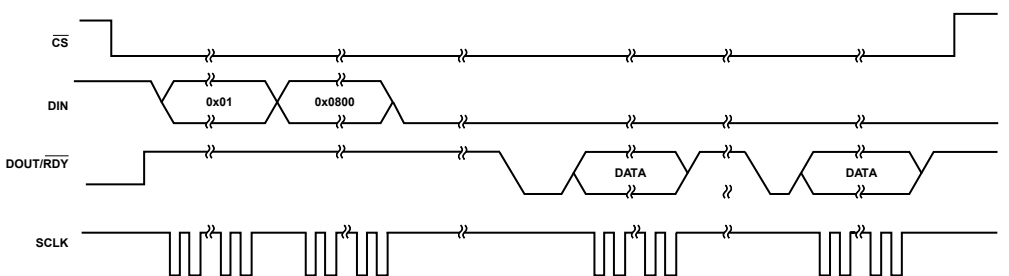

Figure 80. Continuous Read Configuration

## ADC CIRCUIT INFORMATION

### Continuous Read Mode

In the continuous read mode, it is not required to write to the communications register before reading ADC data; apply the required number of SCLKs after DOUT/RDY goes low to indicate the end of a conversion. When the conversion is read, DOUT/RDY returns high until the next conversion is available. In this mode, the data can be read only once. Ensure that the data-word is read before the next conversion is complete. If the conversion is not read before the completion of the next conversion, or if insufficient serial clocks are applied to the ADFS7124-8 to read the word, the serial output register is reset when the next conversion is complete, and the new conversion is placed in the output serial register. The ADC must be configured for the continuous conversion mode to use the continuous read mode.

To enable the continuous read mode, set the CONT\_READ bit in the ADC\_CONTROL register. When this bit is set, the only serial interface operations possible are reads from the data register. To exit the continuous read mode, write a read data command (0x42) while the DOUT/RDY pin is low. Alternatively, apply a software reset, that is, 64 SCLKs with CS = 0 and DIN = 1. This resets the ADC and all register contents. These are the only commands that the interface recognizes after it is placed in the continuous read mode. DIN must be held low in the continuous read mode until an instruction is to be written to the device.

If multiple ADC channels are enabled, each channel is output in turn, with the status bits being appended to the data if DATA\_STATUS is set in the ADC\_CONTROL register. The status register indicates the channel to which the conversion corresponds.

### DATA\_STATUS

The contents of the status register can be appended to each conversion on the ADFS7124-8. This is a useful function if several channels are enabled. Each time a conversion is output, the contents of the status register are appended. The four LSBs of the status register indicate to which channel the conversion corresponds. In addition, determine if any errors are being flagged through the ERROR\_FLAG bit. To append the status register contents to every conversion, the DATA\_STATUS bit in the ADC\_CONTROL register is set to 1.

### SERIAL INTERFACE RESET (DOUT\_RDY\_DEL AND CS\_EN BITS)

The instant at which the DOUT/RDY pin changes from being a DOUT pin to a RDY pin is programmable on the ADFS7124-8. By default, the DOUT/RDY pin changes functionality after a period of time following the last SCLK rising edge, the SCLK edge on which the LSB is read by the processor. This time is 10 ns minimum by default and, by setting the DOUT\_RDY\_DEL bit in the ADC\_CONTROL register to 1, can be extended to 110 ns minimum.

By setting the CS\_EN bit in the ADC\_CONTROL register to 1, the DOUT/RDY pin continues to output the LSB of the register being

read until CS is taken high. This configuration is useful if the CS signal is used to frame all read operations. If CS is not used to frame all read operations, set CS\_EN to 0 so that DOUT/RDY changes functionality following the last SCLK edge in the read operation.

CS\_EN must be set to 1 and the CS signal must be used to frame all read and write operations when the SPI\_READ\_ERR, SPI\_WRITE\_ERR, and SPI\_SCLK\_CNT\_ERR diagnostic functions are enabled.

The serial interface is always reset on the CS rising edge, that is, the interface is reset to a known state whereby it awaits a write to the communications register. Therefore, if a read or write operation is performed by performing multiple 8-bit data transfers, CS must be held low until the all bits are transferred.

### RESET

The circuitry and serial interface of the ADFS7124-8 can be reset by writing 64 consecutive 1s to the device. This resets the logic, digital filter, and analog modulator, and all on-chip registers are reset to their default values. A reset is automatically performed on power-up. A reset requires a time of 90 MCLK cycles. A reset is useful if the serial interface becomes asynchronous due to noise on the SCLK line.

### CALIBRATION

The ADFS7124-8 provides four calibration modes to eliminate the offset and gain errors on a per setup basis:

- ▶ Internal zero-scale calibration mode
- ▶ Internal full-scale calibration mode
- ▶ System zero-scale calibration mode
- ▶ System full-scale calibration mode

Only one channel can be active during calibration. After each conversion, the ADC conversion result is scaled using the ADC calibration registers before being written to the data register.

The default value of the offset register is 0x800000, and the nominal value of the gain register is 0x5XXXXX. The calibration range of the ADC gain is from  $0.4 \times V_{REF}/\text{gain}$  to  $1.05 \times V_{REF}/\text{gain}$ .

The following equations show the calculations that are used in each calibration mode. In the unipolar mode, the ideal relationship (that is, not taking into account the ADC gain error and offset error) is as follows:

$$Data = \left( \frac{0.75 \times V_{IN}}{V_{REF}} \times 2^{23} - (Offset - 0x800000) \right) \times \frac{Gain}{0x400000} \times 2 \quad (1)$$

In the bipolar mode, the ideal relationship (that is, not taking into account the ADC gain error and offset error) is as follows:



## ADC CIRCUIT INFORMATION

$$Data = \left( \frac{0.75 \times V_{IN}}{V_{REF}} \times 2^{23} - (Offset - 0x800000) \right) \times \frac{Gain}{0x400000} + 0x800000 \quad (2)$$

To start a calibration, write the relevant value to the mode bits in the ADC\_CONTROL register. The DOUT/RDY pin and the RDY bit in the status register go high when the calibration initiates. When the calibration is complete, the contents of the corresponding offset or gain register are updated, the RDY bit in the status register is reset, the DOUT/RDY pin returns low (if CS is low), and the ADFS7124-8 reverts to the idle mode.

During an internal offset calibration, the selected positive analog input pin is disconnected, and it is connected internally to the selected negative analog input pin. So, it is necessary to ensure that the voltage on the selected negative analog input pin does not exceed the allowed limits and is free from excessive noise and interference.

To perform an internal full-scale calibration, a full-scale input voltage is automatically connected to the selected analog input for this calibration. A full-scale calibration is recommended each time the gain of a channel is changed to minimize the full-scale error. When performing internal calibrations, the internal full-scale calibration must be performed before the internal zero-scale calibration. Therefore, write the value 0x800000 to the offset register before performing the internal full-scale calibration, which ensures that the offset register is at its default value. The ADFS7124-8 is factory calibrated at a gain of 1, and the resulting gain coefficient is the default gain coefficient on the device. The device does not support further internal full-scale calibrations at a gain of 1.

System calibrations expect the system zero-scale (offset) and system full-scale (gain) voltages to be applied to the ADC pins before initiating the calibration modes. As a result, errors external to the ADC are removed. The system zero-scale calibration must be performed before the system full-scale calibration.

From an operational point of view, treat a calibration like another ADC conversion. Set the system software to monitor the RDY bit in the status register or the DOUT/RDY pin to determine the end of a calibration through a polling sequence or an interrupt-driven routine.

An internal/system offset calibration and system full-scale calibration requires a time equal to the settling time of the selected filter to be completed. The internal full-scale calibration requires a time equal to four settling periods (gain > 1).

A calibration can be performed at any output data rate. Using lower output data rates results in better calibration accuracy and is accurate for all output data rates. A new calibration is required for a given channel if the reference source or the gain for that channel is changed.

Offset and system full-scale calibrations can be performed in any power mode. Internal full-scale calibrations can be performed in the low power or mid power modes only. Thus, when using the full

power mode, select the mid power or low power mode to perform the internal full-scale calibration. However, an internal full-scale calibration performed in the low power or mid power mode is valid in the full power mode, if the same gain is used.

The offset error is typically  $\pm 15 \mu\text{V}$  for gains of 1 to 8 and  $\pm 200/\text{gain} \mu\text{V}$  for higher output data rates. An internal or system offset calibration reduces the offset error to the order of the noise. The gain error is factory calibrated at ambient temperature and at a gain of 1. Following this calibration, the gain error is  $\pm 0.0025\%$  maximum. Therefore, internal full-scale calibrations at a gain of 1 are not supported on the ADFS7124-8. For other gains, the gain error is  $-0.3\%$ . An internal full-scale calibration at ambient temperature reduces the gain error to  $\pm 0.016\%$  maximum for gains of 2 to 8 and  $\pm 0.025\%$  typically for higher gains. A system full-scale calibration reduces the gain error to the order of the noise.

The ADFS7124-8 provides access to the on-chip calibration registers, allowing the microprocessor to read the calibration coefficients of the device and to write its own calibration coefficients from pre-stored values in the EEPROM. A read or write of the offset and gain registers can be performed at any time except during an internal or self-calibration. The values in the calibration registers are 24 bits wide. The span and offset of the device can also be manipulated using the registers.

### SPAN AND OFFSET LIMITS

Whenever a system calibration mode is used, the amount of offset and span that can be accommodated is limited. The overriding requirement in determining the amount of offset and gain that can be accommodated by the device is the requirement that the positive full-scale calibration limit is  $\leq 1.05 \times V_{REF}/\text{gain}$ . This allows the input range to go 5% above the nominal range. The built-in headroom in the ADFS7124-8 analog modulator ensures that the device still operates correctly with a positive full-scale voltage, which is 5% beyond the nominal.

The range of input span in both the unipolar and bipolar modes has a minimum value of  $0.8 \times V_{REF}/\text{gain}$  and a maximum value of  $2.1 \times V_{REF}/\text{gain}$ . However, the span, which is the difference between the bottom of the ADFS7124-8 input range and the top of its input range, must account for the limitation on the positive full-scale voltage. The amount of offset that can be accommodated depends on whether the unipolar or bipolar mode is being used. The offset must account for the limitation on the positive full-scale voltage. In the unipolar mode, there is considerable flexibility in handling negative (with respect to AINM) offsets. In both the unipolar and bipolar modes, the range of positive offsets that can be handled by the device depends on the selected span. Therefore, in determining the limits for system zero-scale and full-scale calibrations, ensure that the offset range plus the span range does not exceed  $1.05 \times V_{REF}/\text{gain}$ . This is best illustrated by looking at a few examples.

If the device is used in the unipolar mode with a required span of  $0.8 \times V_{REF}/\text{gain}$ , the offset range that the system calibration can handle is from  $-1.05 \times V_{REF}/\text{gain}$  to  $+0.25 \times V_{REF}/\text{gain}$ . If the device

## ADC CIRCUIT INFORMATION

is used in the unipolar mode with a required span of  $V_{REF}/\text{gain}$ , the offset range that the system calibration can handle is from  $-1.05 \times V_{REF}/\text{gain}$  to  $+0.05 \times V_{REF}/\text{gain}$ . Similarly, if the device is used in the unipolar mode and required to remove an offset of  $0.2 \times V_{REF}/\text{gain}$ , the span range that the system calibration can handle is  $0.85 \times V_{REF}/\text{gain}$ .

If the device is used in the bipolar mode with a required span of  $\pm 0.4 \times V_{REF}/\text{gain}$ , then the offset range that the system calibration can handle is from  $-0.65 \times V_{REF}/\text{gain}$  to  $+0.65 \times V_{REF}/\text{gain}$ . If the device is used in the bipolar mode with a required span of  $\pm V_{REF}/\text{gain}$ , the offset range the system calibration can handle is from  $-0.05 \times V_{REF}/\text{gain}$  to  $+0.05 \times V_{REF}/\text{gain}$ . Similarly, if the device is used in the bipolar mode and required to remove an offset of  $\pm 0.2 \times V_{REF}/\text{gain}$ , the span range that the system calibration can handle is  $\pm 0.85 \times V_{REF}/\text{gain}$ .

## SYSTEM SYNCHRONIZATION

The  $\overline{\text{SYNC}}$  input allows the user to reset the modulator and digital filter without affecting any of the setup conditions on the device. This allows the user to start gathering samples of the analog input from a known point in time, that is, the rising edge of  $\overline{\text{SYNC}}$ . Take  $\overline{\text{SYNC}}$  low for at least four controller clock cycles to implement the synchronization function.

If multiple ADFS7124-8 devices are operated from a common controller clock, they can be synchronized so that their data registers are updated simultaneously. A falling edge on the  $\overline{\text{SYNC}}$  pin resets the digital filter and analog modulator, and places the ADFS7124-8 into a consistent, known state. While the  $\overline{\text{SYNC}}$  pin is low, the ADFS7124-8 is maintained in this state. On the  $\overline{\text{SYNC}}$  rising edge, the modulator and filter exit this reset state and, on the next clock edge, the device starts to gather input samples again. In a system using multiple ADFS7124-8 devices, a common signal to their  $\overline{\text{SYNC}}$  pins synchronizes their operation. This is normally performed after each ADFS7124-8 has performed its own calibration or has calibration coefficients loaded into its calibration registers. The conversions from the ADFS7124-8 devices are then synchronized.

The device exits reset on the controller clock falling edge following the  $\overline{\text{SYNC}}$  low to high transition. Therefore, when multiple devices are being synchronized, pull the  $\overline{\text{SYNC}}$  pin high on the controller clock rising edge to ensure that all devices begin sampling on the controller clock falling edge. If the  $\overline{\text{SYNC}}$  pin is not taken high in sufficient time, it is possible to have a difference of one controller clock cycle between the devices; that is, the instant at which conversions are available differs from device to device by a maximum of one controller clock cycle.

The  $\overline{\text{SYNC}}$  pin can also be used as a start conversion command. In this mode, the rising edge of  $\overline{\text{SYNC}}$  starts conversion and the falling edge of  $\overline{\text{RDY}}$  indicates when the conversion is complete. The settling time of the filter must be allowed for each data register update. For example, if the ADC is configured to use the  $\text{sinc}^4$  filter and zero latency is disabled, the settling time equals  $4/f_{\text{ADC}}$ ,

where  $f_{\text{ADC}}$  is the output data rate when continuously converting on a single channel.

DIGITAL FILTER

Table 54. Filter Registers

Reg.	Name	Bit 7	Bit 6	Bit 5	Bit 4	Bit 3	Bit 2	Bit 1	Bit 0	Reset	RW
0x21 to 0x28	FILTER_0 to FILTER_7	Filter			REJ60	POST_FILTER			SINGLE_CYCLE	0x060180	RW
		0						FS[10:8]			
		FS[7:0]									

The ADFS7124-8 offers a great deal of flexibility in the digital filter. The device has several filter options. The option selected affects the output data rate, settling time, and 50 Hz and 60 Hz rejection. The following sections describe each filter type, indicating the available output data rates for each filter option. The filter response along with the settling time and 50 Hz and 60 Hz rejection is also discussed.

The filter bits in the filter register select between the sinc type filter.

SINC<sup>4</sup> FILTER

When the ADFS7124-8 is powered up, the sinc<sup>4</sup> filter is selected by default. This filter gives excellent noise performance over the complete range of output data rates. It also gives the best 50 Hz/ 60 Hz rejection, but it has a long settling time. In Figure 81, the blocks shown in gray are unused.

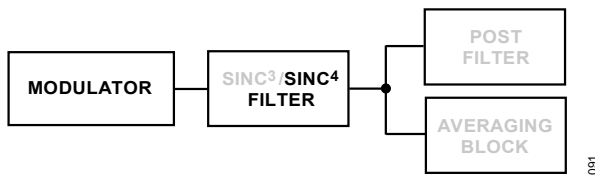

Figure 81. Sinc<sup>4</sup> Filter

Sinc<sup>4</sup> Output Data Rate/Settling Time

The output data rate (the rate at which conversions are available on a single channel when the ADC is continuously converting) is equal to:

$$f_{ADC} = f_{CLK} / (32 \times FS[10:0])$$

where:

$f_{ADC}$  is the output data rate.

$f_{CLK}$  is the controller clock frequency (614.4 kHz in full power mode, 153.6 kHz in mid power mode, and 76.8 kHz in low power mode).

$FS[10:0]$  is the decimal equivalent of the FS[10:0] bits in the filter register. FS[10:0] can have a value from 1 to 2047.

The output data rate can be programmed from:

- ▶ 9.38 SPS to 19,200 SPS for full power mode
- ▶ 2.35 SPS to 4800 SPS for mid power mode
- ▶ 1.17 SPS to 2400 SPS for low power mode

The settling time for the sinc<sup>4</sup> filter is equal to:

$$t_{SETTLE} = (4 \times 32 \times FS[10:0] + Dead\ Time) / f_{CLK}$$

where, *Dead Time* = 61 when  $FS[10:0] = 1$  and 95 when  $FS[10:0] > 1$

When a channel change occurs, the modulator and filter are reset. The settling time is allowed to generate the first conversion after the channel change. Subsequent conversions on this channel occur at  $1/f_{ADC}$ .

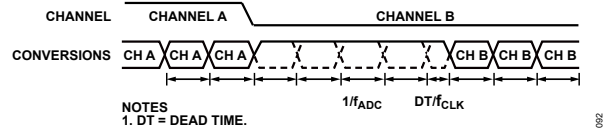

Figure 82. Sinc<sup>4</sup> Channel Change

When conversions are performed on a single channel and a step change occurs, the ADC does not detect the change in the analog input. Therefore, it continues to output conversions at the programmed output data rate. However, it is at least four conversions later before the output data accurately reflects the analog input. If the step change occurs while the ADC is processing a conversion, then the ADC takes five conversions after the step change to generate a fully settled result.

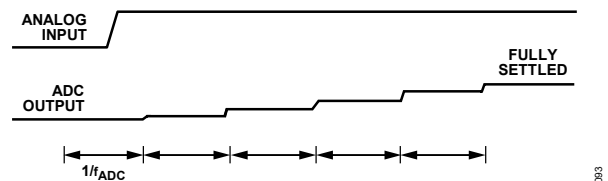

Figure 83. Asynchronous Step Change in the Analog Input

Table 55 gives some examples of the relationship between the values in the FS[10:0] bits and the corresponding output data rate and settling time.

Table 55. Examples of Output Data Rates and the Corresponding Settling Times for the Sinc<sup>4</sup> Filter

Power Mode	FS[10:0]	Output Data Rate (SPS)	Settling Time (ms)
Full Power ( $f_{CLK} = 614.4\text{ kHz}$ )	1920	10	400.15
	384	50	80.15
	320	60	66.82
Mid Power ( $f_{CLK} = 153.6\text{ kHz}$ )	480	10	400.61
	96	50	80.61
	80	60	67.28
Low Power ( $f_{CLK} = 76.8\text{ kHz}$ )	240	10	401.22
	48	50	81.22
	40	60	67.89

## DIGITAL FILTER

Sinc<sup>4</sup> Zero Latency

Zero latency is enabled by setting the SINGLE\_CYCLE bit in the filter register to 1. With zero latency, the conversion time when continuously converting on a single channel approximately equals the settling time. The benefit of this mode is that a similar period of time elapses between all conversions irrespective of whether the conversions occur on one channel or whether several channels are used. When the analog input is continuously sampled on a single channel, the output data rate equals:

$$f_{ADC} = f_{CLK} / (4 \times 32 \times FS[10:0])$$

where:

$f_{ADC}$  is the output data rate.

$f_{CLK}$  is the controller clock frequency.

$FS[10:0]$  is the decimal equivalent of the FS[10:0] bits in the setup filter register.

When selecting another channel, there is an extra delay in the first conversion of:

$$Dead\ Time / f_{CLK}$$

where, *Dead Time* = 61 when FS[10:0] = 1 and 95 when FS[10:0] > 1.

At low output data rates, this extra delay has little impact on the value of the settling time. However, at high output data rates, the delay must be considered. Table 56 summarizes the output data rate when continuously converting on a single channel and the settling time when switching between channels for a sample of FS[10:0] values.

When switching between channels, the ADFS7124-8 allows the complete settling time to generate the first conversion after the channel change. Therefore, the ADC automatically operates in zero latency mode when several channels are enabled (setting the SINGLE\_CYCLE bit has no benefits).

**Table 56. Examples of Output Data Rates and the Corresponding Settling Times for the Sinc<sup>4</sup> Filter (Zero Latency)**

Power Mode	FS[10:0]	Output Data Rate (SPS)	Settling Time (ms)
Full Power ( $f_{CLK} = 614.4$ kHz)	1920	2.5	400.15
	384	12.5	80.15
	320	15	66.82
Mid Power ( $f_{CLK} = 153.6$ kHz)	480	2.5	400.61
	96	12.5	80.61
	80	15	67.28
Low Power ( $f_{CLK} = 76.8$ kHz)	240	2.5	401.22
	48	12.5	81.22
	40	15	67.89

When the analog input is constant or a channel change occurs, valid conversions are available at a near constant output data rate. When conversions are being performed on a single channel and a step change occurs on the analog input, the ADC continues to

output fully settled conversions if the step change is synchronized with the conversion process. If the step change is asynchronous, one conversion is output from the ADC, which is not completely settled (see Figure 84).

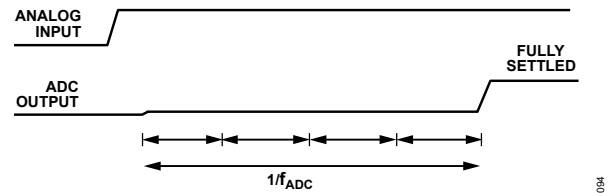

**Figure 84. Sinc<sup>4</sup> Zero Latency Operation**

## Sequencer

The description in the Sinc<sup>4</sup> Filter section is valid when manually switching channels, for example, writing to the device to change channels. When multiple channels are enabled, the on-chip sequencer is automatically used; the device automatically sequences all enabled channels. In this case, the first conversion takes the complete settling time, as listed in Table 55. For all subsequent conversions, the time needed for each conversion is the settling time also, but the dead time is reduced to:

- ▶ 30 when the old channel and the new channel both have an FS[10:0] > 1 or both have an FS[10:0] = 1.
- ▶ -4 when the old channel has an FS[10:0] > 1 and the new channel has an FS[10:0] = 1.
- ▶ 64 when the old channel has an FS[10:0] = 1 and the new channel has an FS[10:0] > 1.

Sinc<sup>4</sup> 50 Hz and 60 Hz Rejection

Figure 85 shows the frequency response of the sinc<sup>4</sup> filter when the output data rate is programmed to 50 SPS and zero latency is disabled. For the same configuration but with zero latency enabled, the filter response remains the same but the output data rate is 12.5 SPS. The sinc<sup>4</sup> filter provides 50 Hz (±1 Hz) rejection in excess of 120 dB minimum, assuming a stable controller clock.



DIGITAL FILTER

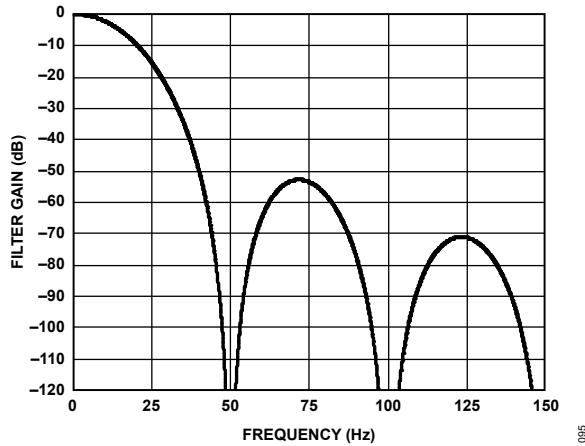

Figure 85. Sinc<sup>4</sup> Filter Response (50 SPS Output Data Rate, Zero Latency Disabled or 12.5 SPS Output Data Rate, Zero Latency Enabled)

Figure 86 shows the frequency response of the sinc<sup>4</sup> filter when the output data rate is programmed to 60 SPS and zero latency is disabled. For the same configuration but with zero latency enabled, the filter response remains the same but the output data rate is 15 SPS. The sinc<sup>4</sup> filter provides 60 Hz (±1 Hz) rejection of 120 dB minimum, assuming a stable controller clock.

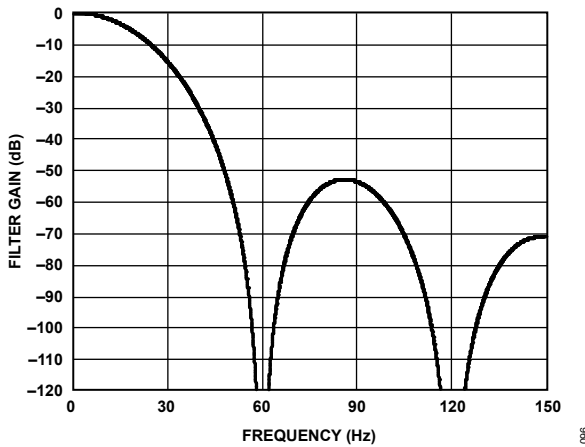

Figure 86. Sinc<sup>4</sup> Filter Response (60 SPS Output Data Rate, Zero Latency Disabled or 15 SPS Output Data Rate, Zero Latency Enabled)

When the output data rate is 10 SPS with zero latency disabled or 2.5 SPS with zero latency enabled, simultaneous 50 Hz and 60 Hz rejection is obtained. The sinc<sup>4</sup> filter provides 50 Hz (±1 Hz) and 60 Hz (±1 Hz) rejection of 120 dB minimum, assuming a stable controller clock.

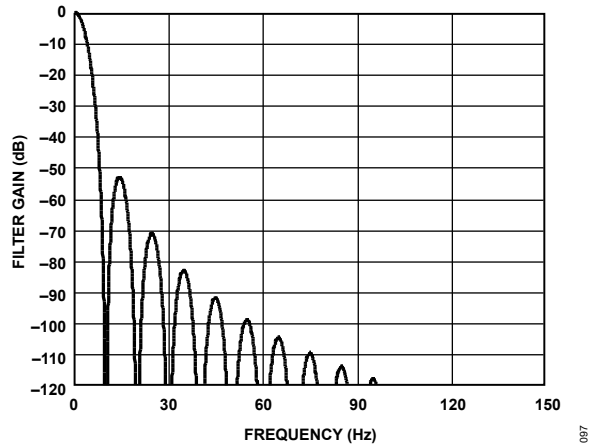

Figure 87. Sinc<sup>4</sup> Filter Response (10 SPS Output Data Rate, Zero Latency Disabled or 2.5 SPS Output Data Rate, Zero Latency Enabled)

Simultaneous 50 Hz/60 Hz rejection can also be achieved using the REJ60 bit in the filter register. When the sinc filter places a notch at 50 Hz, the REJ60 bit places a first order notch at 60 Hz. The output data rate is 50 SPS when zero latency is disabled and 12.5 SPS when zero latency is enabled. Figure 88 shows the frequency response of the sinc<sup>4</sup> filter. The filter provides 50 Hz ± 1 Hz and 60 Hz ± 1 Hz rejection of 82 dB minimum, assuming a stable controller clock.

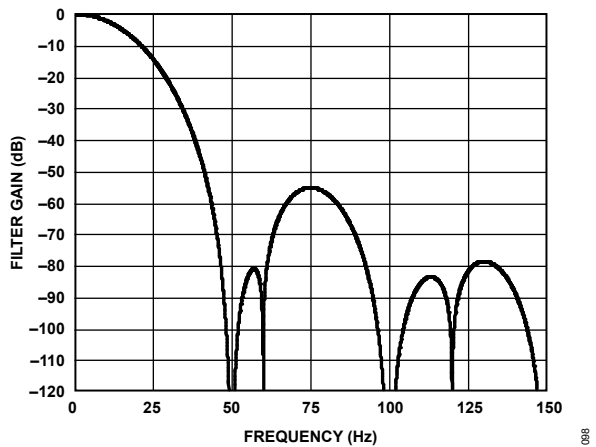

Figure 88. Sinc<sup>4</sup> Filter Response (50 SPS Output Data Rate, Zero Latency Disabled or 12.5 SPS Output Data Rate, Zero Latency Enabled, REJ60 = 1)

SINC<sup>3</sup> FILTER

A sinc<sup>3</sup> filter can be used instead of the sinc<sup>4</sup> filter. The filter is selected using the filter bits in the filter register. This filter has good noise performance, moderate settling time, and moderate 50 Hz and 60 Hz (±1 Hz) rejection. In Figure 89, the blocks shown in gray are unused.

DIGITAL FILTER

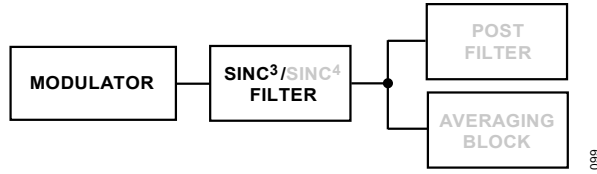

Figure 89. Sinc<sup>3</sup> Filter

Sinc<sup>3</sup> Output Data Rate and Settling Time

The output data rate (the rate at which conversions are available on a single channel when the ADC is continuously converting) equals:

$$f_{ADC} = f_{CLK} / (32 \times FS[10:0])$$

where:

$f_{ADC}$  is the output data rate.

$f_{CLK}$  is the controller clock frequency (614.4 kHz in full power mode, 153.6 kHz in mid power mode and 76.8 kHz in low power mode).

$FS[10:0]$  is the decimal equivalent of the FS[10:0] bits in the filter register. FS[10:0] can have a value from 1 to 2047.

The output data rate can be programmed from:

- ▶ 9.38 SPS to 19,200 SPS for full power mode
- ▶ 2.35 SPS to 4800 SPS for mid power mode
- ▶ 1.17 SPS to 2400 SPS for low power mode

The settling time for the sinc<sup>3</sup> filter is equal to:

$$t_{SETTLE} = (3 \times 32 \times FS[10:0] + Dead\ Time) / f_{CLK}$$

where,  $Dead\ Time = 61$  when  $FS[10:0] = 1$  and  $95\ FS[10:0] > 1$ .

Table 57 gives some examples of FS[10:0] settings and the corresponding output data rates and settling times.

Table 57. Examples of Output Data Rates and the Corresponding Settling Times for the Sinc<sup>3</sup> Filter

Power Mode	FS[10:0]	Output Data Rate (SPS)	Settling Time (ms)
Full Power ( $f_{CLK} = 614.4\ kHz$ )	1920	10	300.15
	384	50	60.15
	320	60	50.15
Mid Power ( $f_{CLK} = 153.6\ kHz$ )	480	10	300.61
	96	50	60.61
	80	60	50.61
Low Power ( $f_{CLK} = 76.8\ kHz$ )	240	10	301.22
	48	50	61.22
	40	60	51.22

When a channel change occurs, the modulator and filter are reset. The complete settling time is allowed to generate the first conversion after the channel change (see Figure 90). Subsequent conversions on this channel are available at  $1/f_{ADC}$ .

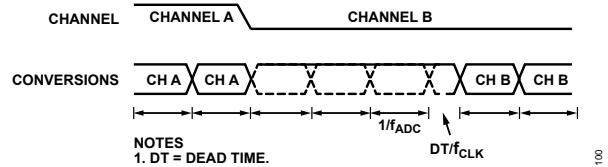

Figure 90. Sinc<sup>3</sup> Channel Change

When conversions are performed on a single channel and a step change occurs, the ADC does not detect the change in the analog input. Therefore, it continues to output conversions at the programmed output data rate. However, it is at least three conversions later before the output data accurately reflects the analog input. If the step change occurs while the ADC is processing a conversion, the ADC takes four conversions after the step change to generate a fully settled result.

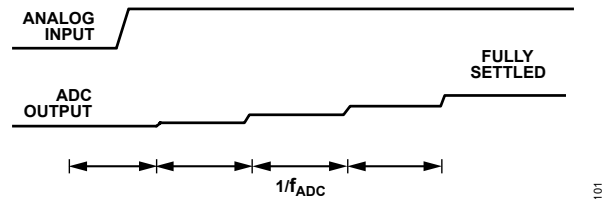

Figure 91. Asynchronous Step Change in the Analog Input

Sinc<sup>3</sup> Zero Latency

Zero latency is enabled by setting the SINGLE\_CYCLE bit in the filter register to 1. With zero latency, the conversion time when continuously converting on a single channel approximately equals the settling time. The benefit of this mode is that a similar period of time elapses between all conversions irrespective of whether the conversions occur on one channel or whether several channels are used.

When the analog input is continuously sampled on a single channel, the output data rate equals:

$$f_{ADC} = f_{CLK} / (3 \times 32 \times FS[10:0])$$

where:

$f_{ADC}$  is the output data rate.

$f_{CLK}$  is the controller clock frequency.

$FS[10:0]$  is the decimal equivalent of the FS[10:0] bits in the filter register.

When switching channels, there is an extra delay in the first conversion of:

$$Dead\ Time / f_{CLK}$$

where  $Dead\ Time = 61$  when  $FS[10:0] = 1$  or  $95$  when  $FS[10:0] > 1$ .

At low output data rates, this extra delay has little impact on the value of the settling time. However, at high output data rates, the delay must be considered. Table 58 summarizes the output data rate when continuously converting on a single channel and the

**DIGITAL FILTER**

settling time when switching between channels for a sample of FS[10:0].

When selecting another channel, the ADFS7124-8 allows the complete settling time to generate the first conversion after the channel change. Therefore, the ADC automatically operates in the zero latency mode when several channels are enabled (setting the SINGLE\_CYCLE bit has no benefits).

When the analog input is constant or a channel change occurs, valid conversions are available at a near constant output data rate. When conversions are being performed on a single channel and a step change occurs on the analog input, the ADC continues to output fully settled conversions if the step change is synchronized with the conversion process. If the step change is asynchronous, one conversion is output from the ADC that is not completely settled (see Figure 92).

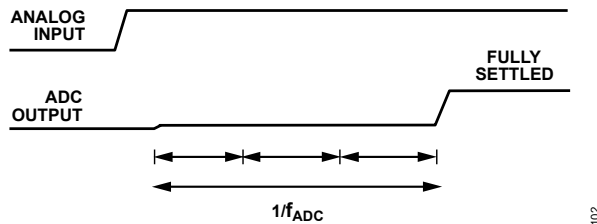

Figure 92. Sinc<sup>3</sup> Zero Latency Operation

Table 58. Examples of Output Data Rates and the Corresponding Settling Times for the Sinc<sup>3</sup> Filter (Zero Latency)

Power Mode	FS[10:0]	Output Data Rate (SPS)	Settling Time (ms)
Full Power (f <sub>CLK</sub> = 614.4 kHz)	1920	3.33	300.15
	384	16.67	60.15
	320	20	50.15
Mid Power (f <sub>CLK</sub> = 153.6 kHz)	480	3.33	300.61
	96	16.67	60.61
	80	20	50.61
Low Power (f <sub>CLK</sub> = 76.8 kHz)	240	3.33	301.22
	48	16.67	61.22
	40	20	51.22

**Sequencer**

The description in the Sinc<sup>3</sup> Filter section is valid when manually switching channels, for example, writing to the device to change channels. When multiple channels are enabled, the on-chip sequencer is automatically used; the device automatically sequences between all enabled channels. In this case, the first conversion takes the complete settling time, as listed in Table 57. For all subsequent conversions, the time needed for each conversion is also the settling time, but the dead time is reduced to:

- ▶ 30 when the old channel and new channel both have an FS[10:0] > 1 or FS[10:0] = 1.

- ▶ -4 when the old channel has an FS[10:0] > 1 and the new channel has an FS[10:0] = 1.
- ▶ 64 when the old channel has an FS[10:0] = 1 and the new channel has an FS[10:0] > 1.

**Sinc<sup>3</sup> 50 Hz and 60 Hz Rejection**

Figure 93 shows the frequency response of the sinc<sup>3</sup> filter when the output data rate is programmed to 50 SPS and zero latency is disabled. For the same configuration but with zero latency enabled, the filter response remains the same but the output data rate is 16.67 SPS. The sinc<sup>3</sup> filter gives 50 Hz ± 1 Hz rejection of 95 dB minimum for a stable controller clock.

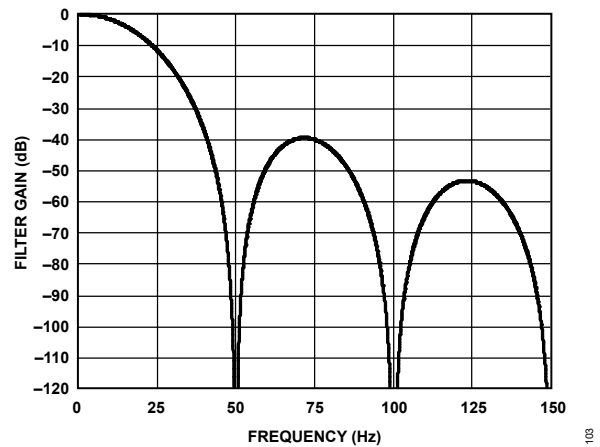

Figure 93. Sinc<sup>3</sup> Filter Response (50 SPS Output Data Rate, Zero Latency Disabled or 16.67 SPS Output Data Rate, Zero Latency Enabled)

Figure 94 shows the frequency response of the sinc<sup>3</sup> filter when the output data rate is programmed to 60 SPS and zero latency is disabled. For the same configuration but with zero latency enabled, the filter response remains the same but the output data rate is 20 SPS. The sinc<sup>3</sup> filter has rejection of 95 dB minimum at 60 Hz ± 1 Hz, assuming a stable controller clock.

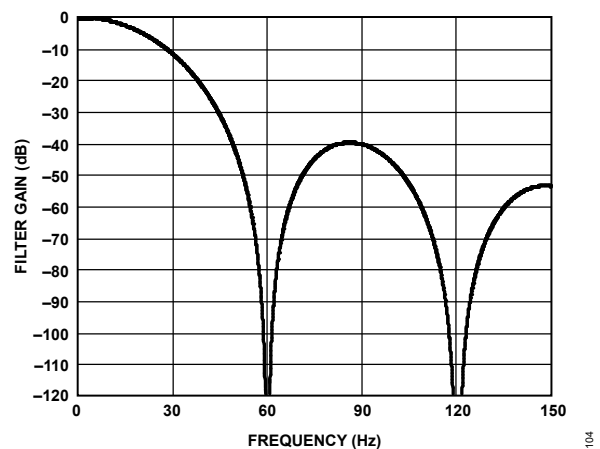

Figure 94. Sinc<sup>3</sup> Filter Response (60 SPS Output Data Rate, Zero Latency Disabled or 20 SPS Output Data Rate, Zero Latency Enabled)

DIGITAL FILTER

When the output data rate is 10 SPS with zero latency disabled or 3.33 SPS with zero latency enabled, simultaneous 50 Hz and 60 Hz rejection is obtained. The sinc<sup>3</sup> filter has rejection of 100 dB minimum at 50 Hz ± 1 Hz and 60 Hz ± 1 Hz (see Figure 95).

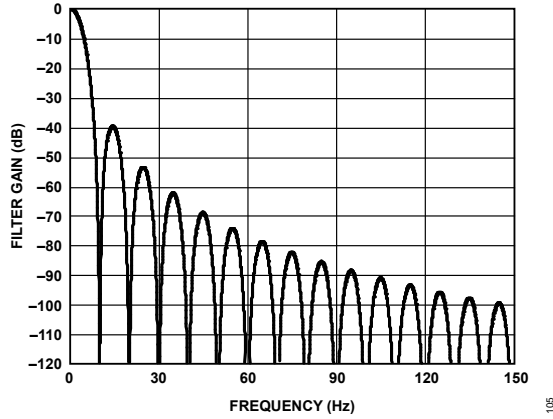

Figure 95. Sinc<sup>3</sup> Filter Response (10 SPS Output Data Rate, Zero Latency Disabled or 3.33 SPS Output Data Rate, Zero Latency Enabled)

Simultaneous 50 Hz and 60 Hz rejection can also be achieved using the REJ60 bit in the filter register. When the sinc filter places a notch at 50 Hz, the REJ60 bit places a first order notch at 60 Hz. The output data rate is 50 SPS when zero latency is disabled and 16.67 SPS when zero latency is enabled. Figure 96 shows the frequency response of the sinc<sup>3</sup> filter with this configuration. Assuming a stable clock, the rejection at 50 Hz and 60 Hz (± 1 Hz) is in excess of 67 dB minimum.

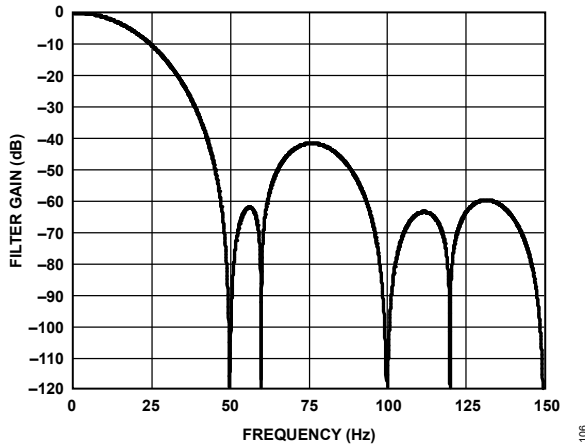

Figure 96. Sinc<sup>3</sup> Filter Response (50 SPS Output Data Rate, Zero Latency Disabled or 16.67 SPS Output Data Rate, Zero Latency Enabled, REJ60 = 1)

FAST SETTLING MODE (SINC<sup>4</sup> + SINC<sup>1</sup> FILTER)

In the fast settling mode, the settling time is close to the inverse of the first filter notch; therefore, it is possible to achieve 50 Hz and/or 60 Hz rejection at an output data rate close to 1/50 Hz or 1/60 Hz. The settling time is approximately equal to 1/output data rate.

Therefore, the conversion time is near constant when converting on a single channel or when converting on several channels.

Enable the fast settling mode using the filter bits in the filter register. In the fast settling mode, a sinc<sup>1</sup> filter is included after the sinc<sup>4</sup> filter. The sinc<sup>1</sup> filter averages by 16 in the full power and mid power modes, and averages by 8 in the low power mode. In Figure 97, the blocks shown in gray are unused.

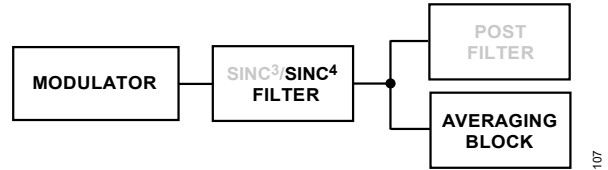

Figure 97. Fast Settling Mode, Sinc<sup>4</sup> + Sinc<sup>1</sup> Filter

Output Data Rate and Settling Time, Sinc<sup>4</sup> + Sinc<sup>1</sup> Filter

When continuously converting on a single channel, the output data rate is:

$$f_{ADC} = f_{CLK} / (Avg \times 32 \times FS[10:0])$$

where:

$f_{ADC}$  is the output data rate.

$f_{CLK}$  is the controller clock frequency (614.4 kHz in full power mode, 153.6 kHz in mid power mode, and 76.8 kHz in low power mode).

Avg is 16 for the full or mid power mode and 8 for low power mode.

FS[10:0] is the decimal equivalent of the FS[10:0] bits in the filter register. FS[10:0] can have a value from 1 to 2047.

When another channel is selected, there is an extra delay in the first conversion. The settling time is equal to:

$$t_{SETTLE} = ((4 + Avg - 1) \times 32 \times FS[10:0] + Dead Time) / f_{CLK}$$

where, Dead Time = 95.

Table 59 lists sample FS[10:0] settings and the corresponding output data rates and settling times.

Table 59. Examples of Output Data Rates and the Corresponding Settling Times (Fast Settling Mode, Sinc<sup>4</sup> + Sinc<sup>1</sup>)

Power Mode	FS[10:0]	First Notch (Hz)	Output Data Rate (SPS)	Settling Time (ms)
Full Power ( $f_{CLK} = 614.4$ kHz, Average by 16)	120	10	10	118.9
	24	50	50	23.9
	20	60	60	19.94
Mid Power ( $f_{CLK} = 153.6$ kHz, Average by 16)	30	10	10	119.36
	6	50	50	24.36
	5	60	60	20.4
Low Power ( $f_{CLK} = 76.8$ kHz, Average by 8)	30	10	10	138.72
	6	50	50	28.72
	5	60	60	24.14

**DIGITAL FILTER**

When the analog input is constant or a channel change occurs, valid conversions are available at a near constant output data rate.

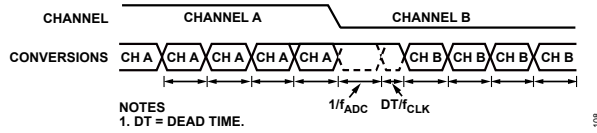

Figure 98. Fast Settling,  $Sinc^4 + Sinc^1$  Filter

When the device is converting on a single channel and a step change occurs on the analog input, the ADC does not detect the change and continues to output conversions. If the step change is synchronized with the conversion, there is one intermediate result, which is not completely settled (see Figure 99). If the step change is asynchronous to the conversion process, there is one or two intermediate results, which are not completely settled.

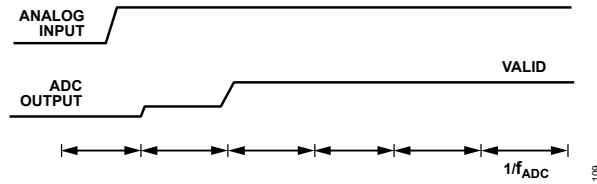

Figure 99. Step Change on the Analog Input,  $Sinc^4 + Sinc^1$  Filter

**Sequencer**

The description in the [Fast Settling Mode \(Sinc4 + Sinc1 Filter\)](#) section is valid when manually switching channels, for example, writing to the device to change channels. When multiple channels are enabled, the on-chip sequencer is automatically used; the device automatically sequences between all enabled channels. In this case, the first conversion takes the complete settling time, as listed in [Table 59](#). For all subsequent conversions, the time needed for each conversion is also the settling time, but the dead time is reduced to 30.

**50 Hz and 60 Hz Rejection,  $Sinc^4 + Sinc^1$  Filter**

Figure 100 shows the frequency response when FS[10:0] is set to 24 in the full power mode, or 6 in the mid power mode or low power mode. [Table 59](#) lists the corresponding output data rate. The sinc filter places the first notch at:

$$f_{NOTCH} = f_{CLK} / (32 \times FS[10:0])$$

The  $sinc^1$  filter places notches at  $f_{NOTCH}/Avg$  (Avg equaling 16 for the full power mode and mid power mode, and equaling 8 for the low power mode). Notches are also placed at multiples of this frequency; therefore, when FS[10:0] is set to 24 in the full power mode or 6 in the mid power mode, a notch is placed at 800 Hz due to the sinc filter, and notches are placed at 50 Hz and multiples of 50 Hz due to the averaging. In the low power mode, a notch is placed at 400 Hz due to the sinc filter, and notches are placed at 50 Hz and multiples of 50 Hz due to the averaging.

The notch at 50 Hz is a first-order notch; therefore, the notch is not wide. This means that the rejection at 50 Hz exactly is good, assuming a stable controller clock. However, in a band of  $50\text{ Hz} \pm 1\text{ Hz}$ , the rejection degrades significantly. The rejection at  $50\text{ Hz} \pm 0.5\text{ Hz}$  is 40 dB minimum, assuming a stable clock; therefore, a good controller clock source is recommended when using the fast settling mode.

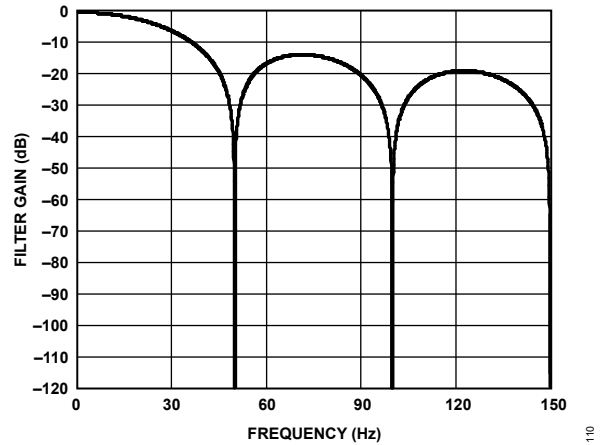

Figure 100. 50 Hz Rejection

Figure 101 shows the filter response when FS[10:0] is set to 20 in the full power mode, or 5 in the mid power and low power modes. In this case, a notch is placed at 60 Hz and multiples of 60 Hz. The rejection at  $60\text{ Hz} \pm 0.5\text{ Hz}$  is equal to 40 dB minimum.

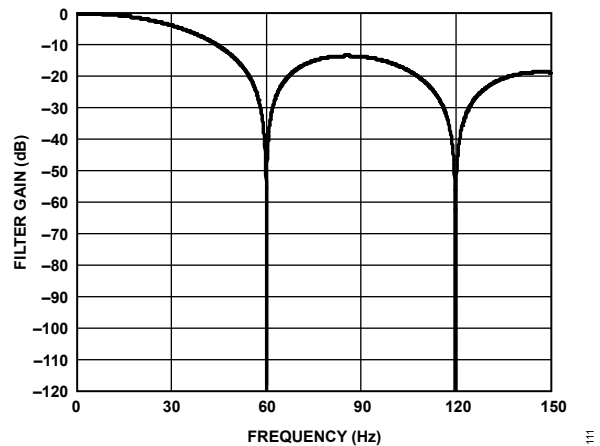

Figure 101. 60 Hz Rejection

Simultaneous 50 Hz/60 Hz rejection is achieved when FS[10:0] is set to 120 in the full power mode, or 30 in the mid power and low power modes. Notches are placed at 10 Hz and multiples of 10 Hz, thereby giving simultaneous 50 Hz and 60 Hz rejection. The rejection at  $50\text{ Hz} \pm 0.5\text{ Hz}$  and  $60\text{ Hz} \pm 0.5\text{ Hz}$  is 44 dB typically.

DIGITAL FILTER

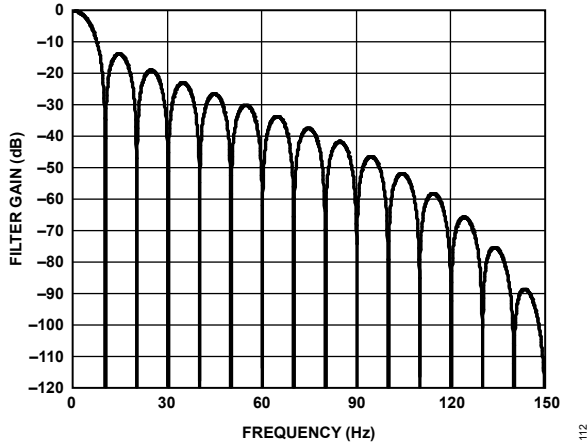

Figure 102. Simultaneous 50 Hz and 60 Hz Rejection

FAST SETTLING MODE (SINC<sup>3</sup> + SINC<sup>1</sup> FILTER)

In the fast settling mode, the settling time is close to the inverse of the first filter notch; therefore, it is possible to achieve 50 Hz and/or 60 Hz rejection at an output data rate close to 1/50 Hz or 1/60 Hz. The settling time is approximately equal to 1/output data rate. Therefore, the conversion time is near constant when converting on a single channel or when converting on several channels.

Enable the fast settling mode using the filter bits in the filter register. In the fast settling mode, a sinc<sup>1</sup> filter is included after the sinc<sup>3</sup> filter. The sinc<sup>1</sup> filter averages by 16 in the full power and mid power modes, and averages by 8 in the low power mode. In Figure 103, the blocks shown in gray are unused.

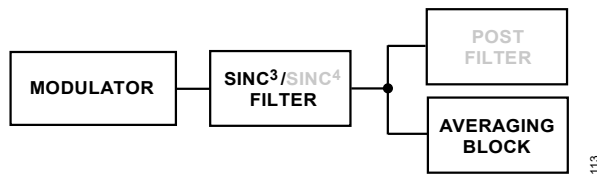

Figure 103. Fast Settling Mode, Sinc<sup>3</sup> + Sinc<sup>1</sup> Filter

Output Data Rate and Settling Time, Sinc<sup>3</sup> + Sinc<sup>1</sup> Filter

When continuously converting on a single channel, the output data rate is:

$$f_{ADC} = f_{CLK} / (Avg \times 32 \times FS[10:0])$$

where:

$f_{ADC}$  is the output data rate.

$f_{CLK}$  is the controller clock frequency (614.4 kHz in full power mode, 153.6 kHz in mid power mode, and 76.8 kHz in low power mode).

$Avg$  is 16 in full or mid power mode and 8 in low power mode.

$FS[10:0]$  is the decimal equivalent of the FS[10:0] bits in the filter register. FS[10:0] can have a value from 1 to 2047.

When another channel is selected, there is an extra delay in the first conversion. The settling time is equal to:

$$t_{SETTLE} = ((3 + Avg - 1) \times 32 \times FS[10:0] + Dead Time) / f_{CLK}$$

where,  $Dead\ Time = 95$ .

Table 60 lists some sample FS[10:0] settings and the corresponding output data rates and settling times.

Table 60. Examples of Output Data Rates and the Corresponding Settling Times (Fast Settling Mode, Sinc<sup>3</sup> + Sinc<sup>1</sup>)

Power Mode	FS[10:0]	First Notch (Hz)	Output Data Rate (SPS)	Settling Time (ms)
Full Power ( $f_{CLK} = 614.4\text{ kHz}$ , Average by 16)	120	10	10	112.65
	24	50	50	22.65
	20	60	60	18.9
Mid Power ( $f_{CLK} = 153.6\text{ kHz}$ , Average by 16)	30	10	10	113.11
	6	50	50	23.11
	5	60	60	19.36
Low Power ( $f_{CLK} = 76.8\text{ kHz}$ , Average by 8)	30	10	10	126.22
	6	50	50	26.22
	5	60	60	22.06

When the analog input is constant or a channel change occurs, valid conversions are available at a near constant output data rate.

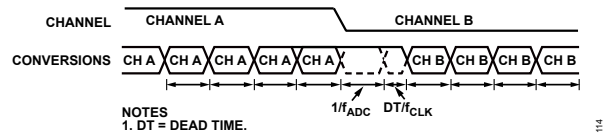

Figure 104. Fast Settling, Sinc<sup>3</sup> + Sinc<sup>1</sup> Filter

When the device is converting on a single channel and a step change occurs on the analog input, the ADC does not detect the change and continues to output conversions. When the step change is synchronized with the conversion, one intermediate result is not completely settled (see Figure 105). If the step change is asynchronous to the conversion process, one or two intermediate results are not completely settled.

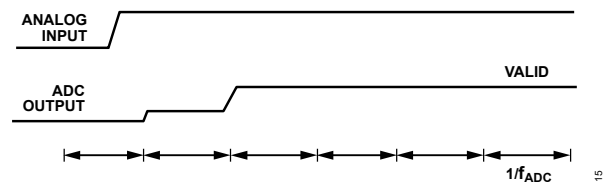

Figure 105. Step Change on the Analog Input, Sinc<sup>3</sup> + Sinc<sup>1</sup> Filter

Sequencer

The description in the Fast Settling Mode (Sinc<sup>3</sup> + Sinc<sup>1</sup> Filter) section is valid when manually switching channels, for example, writing to the device to change channels. When multiple channels are enabled, the on-chip sequencer is automatically used; the device automatically sequences between all enabled channels. In this case, the first conversion takes the complete settling time, as listed in Table 60. For all subsequent conversions, the time needed



**DIGITAL FILTER**

for each conversion is also the settling time, but the dead time is reduced to 30.

**50 Hz and 60 Hz Rejection, Sinc<sup>3</sup> + Sinc<sup>1</sup> Filter**

Figure 106 shows the frequency response when FS[10:0] is set to 24 in the full power mode, or 6 in the mid power mode or low power mode. Table 60 lists the corresponding output data rate.

The sinc filter places the first notch at:

$$f_{NOTCH} = f_{CLK} / (32 \times FS[10:0])$$

The averaging block places notches at  $f_{NOTCH} / Avg$  (Avg equaling 16 for the full power mode and mid power mode, and equaling 8 for the low power mode). Notches are also placed at multiples of this frequency; therefore, when FS[10:0] is set to 24 in the full power mode or 6 in the mid power mode, a notch is placed at 800 Hz due to the sinc filter, and notches are placed at 50 Hz and multiples of 50 Hz due to the averaging. In the low power mode, a notch is placed at 400 Hz due to the sinc filter when FS[10:0] is set to 6, and notches are placed at 50 Hz and multiples of 50 Hz due to the averaging.

The notch at 50 Hz is a first-order notch; therefore, the notch is not wide. This means that the rejection at 50 Hz exactly is good, assuming a stable controller clock. However, in a band of 50 Hz ± 1 Hz, the rejection degrades significantly. The rejection at 50 Hz ± 0.5 Hz is 40 dB minimum, assuming a stable clock; therefore, a good controller clock source is recommended when using the fast settling mode.

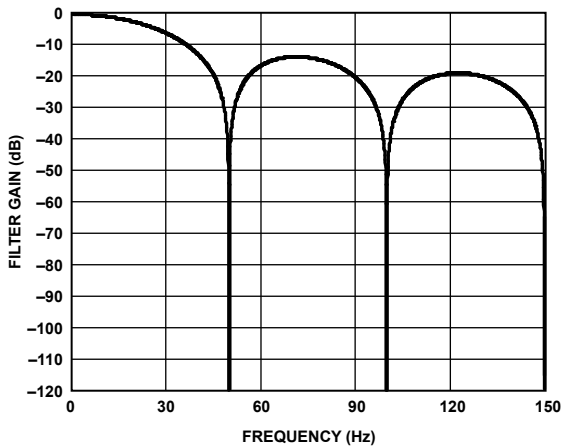

Figure 106. 50 Hz Rejection

Figure 107 shows the filter response when FS[10:0] is set to 20 in the full power mode, or 5 in the mid power and low power modes. In this case, a notch is placed at 60 Hz and multiples of 60 Hz. The rejection at 60 Hz ± 0.5 Hz is equal to 40 dB minimum.

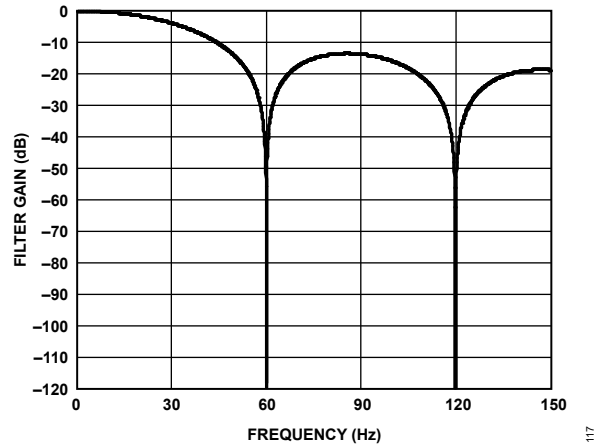

Figure 107. 60 Hz Rejection

Simultaneous 50 Hz/60 Hz rejection is achieved when FS[10:0] is set to 120 in the full power mode, or 30 in the mid power and low power modes. Notches are placed at 10 Hz and multiples of 10 Hz, thereby giving simultaneous 50 Hz and 60 Hz rejection. The rejection at 50 Hz ± 0.5 Hz and 60 Hz ± 0.5 Hz is 42 dB typically.

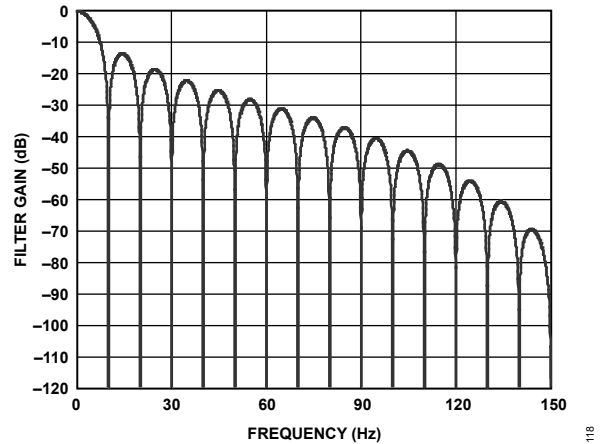

Figure 108. Simultaneous 50 Hz and 60 Hz Rejection

**POST FILTERS**

The post filters provide rejection of 50 Hz and 60 Hz simultaneously and allow the user to trade off settling time and rejection. These filters can operate up to 27.27 SPS or can reject up to 90 dB of 50 Hz ± 1 Hz and 60 Hz ± 1 Hz interference. These filters are realized by post filtering the output of the sinc<sup>3</sup> filter. The filter bits must be set to all 1s to enable the post filter. The post filter option is selected using the POST\_FILTER bits in the filter register. In Figure 109, the blocks shown in gray are unused.

DIGITAL FILTER

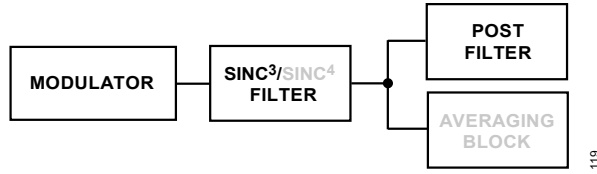

Figure 109. Post Filters

Table 61 shows the output data rates with the accompanying settling times and rejection.

When continuously converting on a single channel, the first conversion requires a time of  $t_{SETTLE}$ . Subsequent conversions occur at  $1/f_{ADC}$ . When multiple channels are enabled (either manually or using the sequencer), the settling time is required to generate a valid conversion on each enabled channel.

Table 61. ADFS7124-8 Post Filters: Output Data Rate, Settling Time ( $t_{SETTLE}$ ), and Rejection

Output Data Rate (SPS)	$f_{3dB}$ (Hz)	$t_{SETTLE}$ , Full Power Mode (ms)	$t_{SETTLE}$ , Mid Power Mode (ms)	$t_{SETTLE}$ , Low Power Mode (ms)	Simultaneous Rejection of 50 Hz $\pm$ 1 Hz and 60 Hz $\pm$ 1 Hz (dB) <sup>1</sup>
27.27	17.28	38.498	38.998	39.662	47
25	15.12	41.831	42.331	42.995	62
20	13.38	51.831	52.331	52.995	86
16.67	12.66	61.831	62.331	62.995	92

<sup>1</sup> Stable controllerclock used.



DIGITAL FILTER

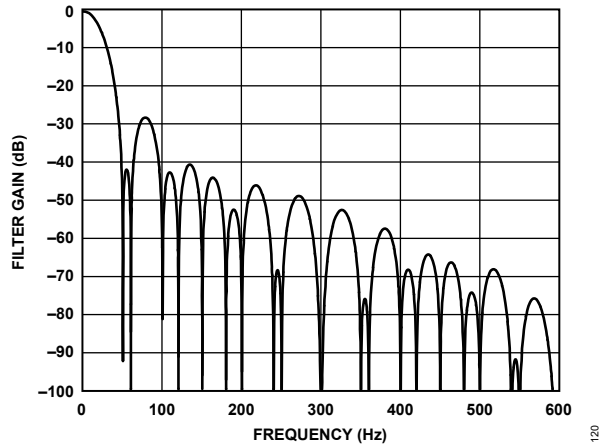

Figure 110. DC to 600 Hz, 27.27 SPS Output Data Rate, 36.67 ms Settling Time

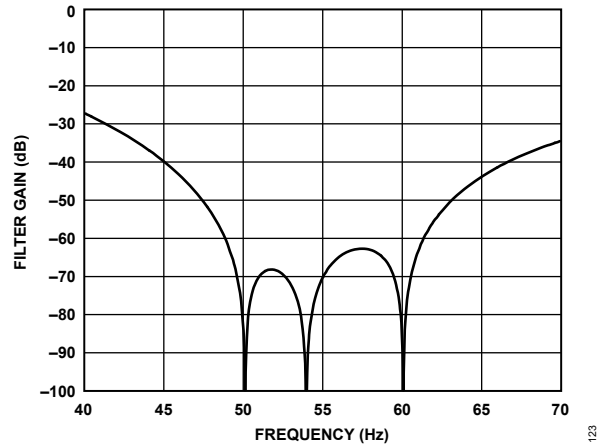

Figure 113. Zoom in 40 Hz to 70 Hz, 25 SPS Output Data Rate, 40 ms Settling Time

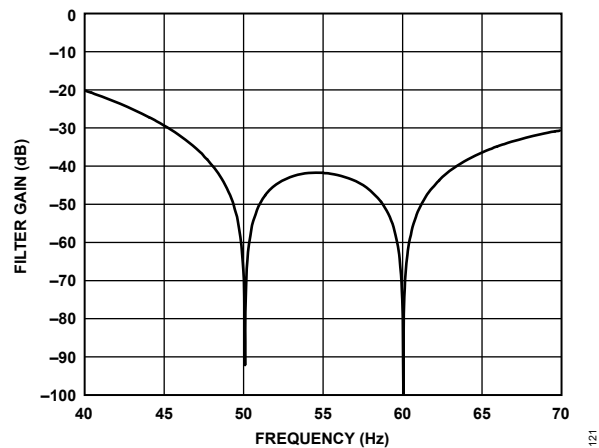

Figure 111. Zoom in 40 Hz to 70 Hz, 27.27 SPS Output Data Rate, 36.67 ms Settling Time

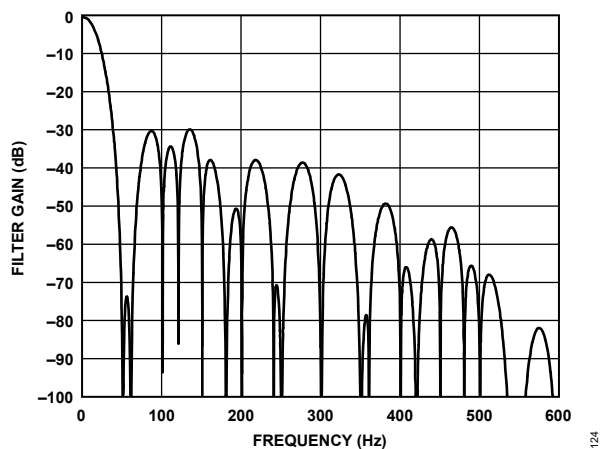

Figure 114. DC to 600 Hz, 20 SPS Output Data Rate, 50 ms Settling Time

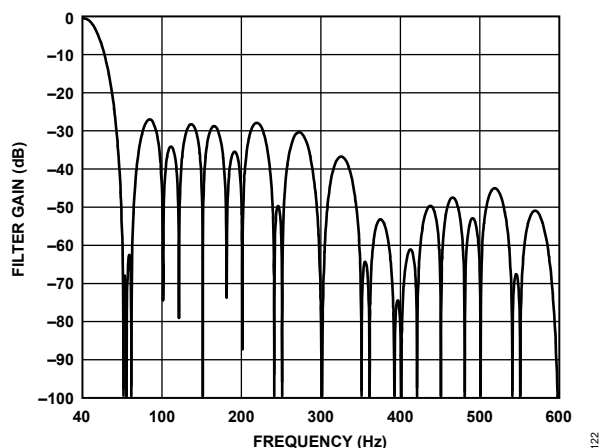

Figure 112. DC to 600 Hz, 25 SPS Output Data Rate, 40 ms Settling Time

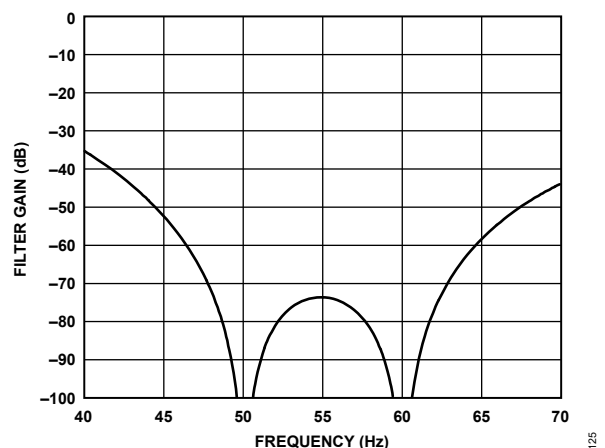

Figure 115. Zoom in 40 Hz to 70 Hz, 20 SPS Output Data Rate, 50 ms Settling Time

DIGITAL FILTER

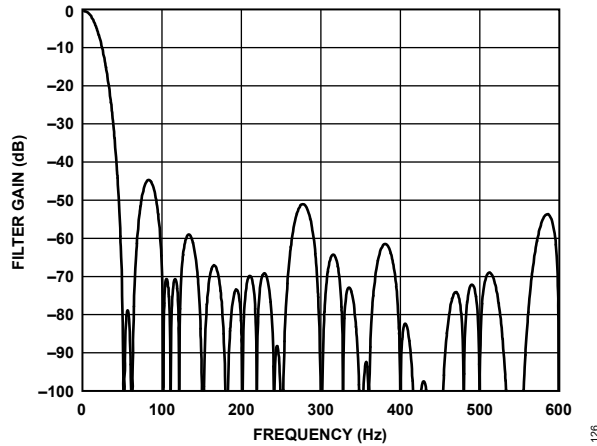

Figure 116. DC to 600 Hz, 16.667 SPS Output Data Rate, 60 ms Settling Time

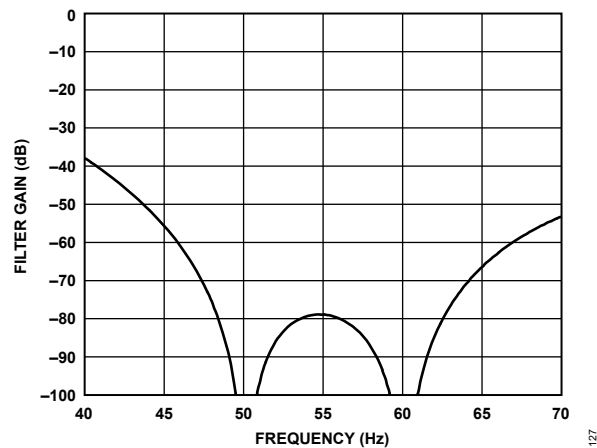

Figure 117. Zoom in 40 Hz to 70 Hz, 16.667 SPS Output Data Rate, 60 ms Settling Time

Table 62. Filter Summary

Filter	Power Mode	Output Data Rate (SPS)	REJ60	50 Hz Rejection (dB) <sup>1,2</sup>
Sinc <sup>4</sup>	All	10	0	120 dB (50 Hz and 60 Hz)
	All	50	0	120 dB (50 Hz only)
	All	50	1	82 dB (50 Hz and 60 Hz)
	All	60	0	120 dB (60 Hz only)
Sinc <sup>4</sup> , Zero Latency	All	12.5	0	120 dB (50 Hz only)
	All	12.5	1	82 dB (50 Hz and 60 Hz)
	All	15	0	120 dB (60 Hz only)
Sinc <sup>3</sup>	All	10	0	100 dB (50 Hz and 60 Hz)
	All	50	0	95 dB (50 Hz only)
	All	50	1	67 dB (50 Hz and 60 Hz)
	All	60	0	95 dB (60 Hz only)
Fast Settling (Sinc <sup>4</sup> + Sinc <sup>1</sup> )	Full/mid	60	0	40 dB (60 Hz only)
	Low	60	0	40 dB (60 Hz only)
	Full/mid	50	0	40 dB (50 Hz only)
	Low	50	0	40 dB (50 Hz only)
	Full/mid	10	0	40 dB (50 Hz and 60 Hz)
	Low	10	0	40 dB (50 Hz and 60 Hz)

SUMMARY OF FILTER OPTIONS

The ADFS7124-8 has several filter options. The chosen filter affects the output data rate, settling time, RMS noise, stop-band attenuation, and the 50 Hz and 60 Hz rejection.

Table 62 shows some sample configurations and the corresponding performance in terms of throughput and 50 Hz and 60 Hz rejection.

## DIGITAL FILTER

Table 62. Filter Summary (Continued)

Filter	Power Mode	Output Data Rate (SPS)	REJ60	50 Hz Rejection (dB) <sup>1, 2</sup>
Fast Settling (Sinc <sup>3</sup> + Sinc <sup>1</sup> )	Full/mid	60	0	40 dB (60 Hz only)
	Low	60	0	40 dB (60 Hz only)
	Full/mid	50	0	40 dB (50 Hz only)
	Low	50	0	40 dB (50 Hz only)
	Full/mid	10	0	40 dB (50 Hz and 60 Hz)
	Low	10	0	40 dB (50 Hz and 60 Hz)
Post Filter	All	27.27	0	47 dB (50 Hz and 60 Hz)
	All	25	0	62 dB (50 Hz and 60 Hz)
	All	20	0	85 dB (50 Hz and 60 Hz)
	All	16.67	0	90 dB (50 Hz and 60 Hz)

<sup>1</sup> These calculations assume a stable controller clock.

<sup>2</sup> For fast settling mode, the 50 Hz/60 Hz rejection is measured in a band of  $\pm 0.5$  Hz around 50 Hz and/or 60 Hz. For all other modes, a region of  $\pm 1$  Hz around 50 Hz and/or 60 Hz is used.

## DIAGNOSTICS

The ADFS7124-8 has numerous diagnostic functions on chip. Use these features to ensure:

- ▶ Read/write operations are to valid registers only.
- ▶ Only valid data is written to the on-chip registers.
- ▶ Appropriate decoupling is used on the LDOs.
- ▶ The external reference, if used, is present.
- ▶ The ADC modulator and filter are working within specification.

### SIGNAL CHAIN CHECK

Functions such as the reference and power supply voltages can be selected as inputs to the ADC. The ADFS7124-8 can therefore check the voltages connected to the device. The ADFS7124-8 also generates an internal 20 mV signal that can be applied internally to a channel by selecting the V\_20MV\_P to V\_20MV\_M channel in the channel register. The internal 20 mV uses a common-mode voltage of 10 mV. Therefore, the absolute voltage of V\_20MV\_M is AV<sub>SS</sub>. If the AINM\_UV\_ERR function is enabled, the AINM\_UV\_ERR flag may be set when the internal 20 mV is being measured. So, ignore the AINM\_UV\_ERR flag status when converting the internal 20 mV signal. The PGA can be checked using this function. As the PGA setting is increased, for example, the signal as a percent of the analog input range is increased by a factor of two. This allows the user to check that the PGA is functioning correctly. Note that the internal 20 mV cannot be used to test the signal chain at a gain of 1, AIN\_BUFM and/or AIN\_BUFM buffer enabled as the buffer requires 100 mV of headroom. To test the signal chain for this configuration, the power supply or LDO can be selected as the analog input.

### REFERENCE DETECT

The ADFS7124-8 includes on-chip circuitry to detect if there is a valid reference for conversions or calibrations when selecting an external reference as the reference source. This is a valuable feature in applications such as RTDs or strain gages where the reference is derived externally.

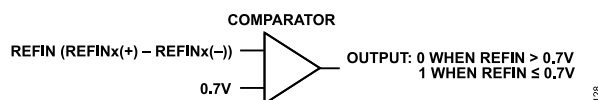

Figure 118. Reference Detect Circuitry

This feature is enabled when the REF\_DET\_ERR\_EN bit in the ERROR\_EN register is set to 1. If the voltage between the selected REFINx(+) and REFINx(-) pins goes below 0.7 V, or either the REFINx(+) or REFINx(-) inputs are open circuit, the ADFS7124-8 detects that it no longer has a valid reference. In this case, the REF\_DET\_ERR bit in the error register is set to 1. The ERR bit in the status register is also set.

If the ADFS7124-8 is performing normal conversions and the REF\_DET\_ERR bit becomes active, the conversion results revert to all 1s. Therefore, it is not necessary to continuously monitor the status of the REF\_DET\_ERR bit when performing conversions. It is

only necessary to verify its status if the conversion result read from the ADC data register is all 1s.

If the ADFS7124-8 is performing either offset or full-scale calibrations and the REF\_DET\_ERR bit becomes active, the updating of the respective calibration register is inhibited to avoid loading incorrect coefficients to the register, and the REF\_DET\_ERR bit is set. If there is a concern about verifying that a valid reference is in place every time a calibration is performed, check the status of the REF\_DET\_ERR bit at the end of the calibration cycle.

The reference detect flag may be set when the device exits the standby mode. Therefore, read the error register after exiting the standby mode to reset the flag to 0.

### CALIBRATION, CONVERSION, AND SATURATION ERRORS

The conversion process and calibration process can also be monitored by the ADFS7124-8. These diagnostics check the analog input used as well as the modulator and digital filter during conversions or calibration. The functions can be enabled using the ADC\_CAL\_ERR\_EN, ADC\_CONV\_ERR\_EN, and ADC\_SAT\_ERR\_EN bits in the ERROR\_EN register. With these functions enabled, the ADC\_CAL\_ERR, ADC\_CONV\_ERR, and ADC\_SAT\_ERR bits are set if an error occurs.

The ADC\_CONV\_ERR flag is set if there is an overflow or underflow in the digital filter. The ADC conversion clamps to all 0s or all 1s also. This flag is updated in conjunction with the update of the data register and can be cleared only by a read of the error register.

The ADC\_SAT\_ERR flag is set if the modulator outputs 20 consecutive 1s or 0s. This indicates that the modulator has saturated.

When an offset calibration is performed, the resulting offset coefficient must be between 0x7FFFF and 0xF80000. If the coefficient is outside this range, the offset register is not updated and the ADC\_CAL\_ERR flag is set. During a full-scale calibration, overflow of the digital filter is checked. If an overflow occurs, the error flag is set and the gain register is not updated.

### OVERVOLTAGE/UNDERVOLTAGE DETECTION

The overvoltage/undervoltage monitors check the absolute voltage on the AINx analog input pins. The absolute voltage must be within specification to meet the data sheet specifications. If the ADC is operated outside the data sheet limits, linearity degrades.

DIAGNOSTICS

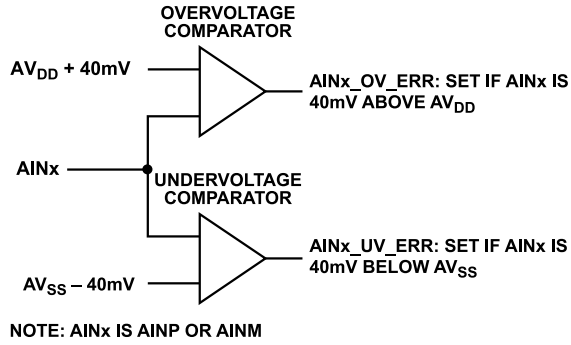

Figure 119. Analog Input Overvoltage/Undervoltage Monitors

The positive (AINP) and negative (AINM) analog inputs can be separately checked for overvoltages and undervoltages. The AINP\_OV\_ERR\_EN and AINP\_UV\_ERR\_EN bits in the ERROR\_EN register enable the overvoltage/undervoltage diagnostics respectively. An overvoltage is flagged when the voltage on AINP exceeds AV<sub>DD</sub>, while an undervoltage is flagged when the voltage on AINP goes below AV<sub>SS</sub>. Similarly, an overvoltage/undervoltage check on the negative analog input pin is enabled using the AINM\_OV\_ERR\_EN and AINM\_UV\_ERR\_EN bits in the ERROR\_EN register. The error flags are AINP\_OV\_ERR, AINP\_UV\_ERR, AINM\_OV\_ERR, and AINM\_UV\_ERR in the error register.

When this function is enabled, the corresponding flags may be set in the error register. Therefore, read the error register when the overvoltage/undervoltage checks are enabled to ensure that the flags are reset to 0.

POWER SUPPLY MONITORS

Along with converting external voltages, the ADC can monitor the voltage on the AV<sub>DD</sub> pin and the IOV<sub>DD</sub> pin. When the inputs of AV<sub>DD</sub> to AV<sub>SS</sub> or IOV<sub>DD</sub> to DGND are selected, the voltage (AV<sub>DD</sub> to AV<sub>SS</sub> or IOV<sub>DD</sub> to DGND) is internally attenuated by 6, and the resulting voltage is applied to the Σ-Δ modulator. This is useful because variations in the power supply voltage can be monitored.

LDO MONITORING

There are several LDO checks included on the ADFS7124-8. Like the external power supplies, the voltage generated by the analog and digital LDOs are selectable as inputs to the ADC. In addition, the ADFS7124-8 can continuously monitor the LDO voltages.

Power Supply Monitor

The voltage generated by the ALDO and DLDO can be monitored by enabling the ALDO\_PSM\_ERR\_EN bit and the DLDO\_PSM\_ERR\_EN bit, respectively, in the ERROR\_EN register. When enabled, the output voltage of the LDO is continuously monitored. If the ALDO voltage drops below 1.6 V, the ALDO\_PSM\_ERR flag is asserted. If the DLDO voltage drops below 1.55 V, the DLDO\_PSM\_ERR flag is asserted. The bit remains set

until the corresponding LDO voltage recovers. However, the bit is only cleared when the error register is read.



Figure 120. Analog LDO Monitor

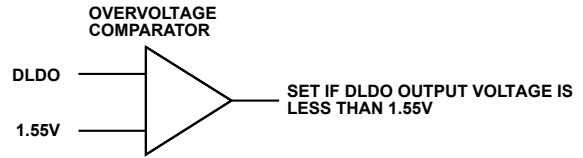

Figure 121. Digital LDO Monitor

The ADFS7124-8 can also test the circuitry used for the power supply monitoring. When the ALDO\_PSM\_TRIP\_TEST\_EN or DLDO\_PSM\_TRIP\_TEST\_EN bits are set, the input to the test circuitry is tied to GND rather than the LDO output. Set the corresponding ALDO\_PSM\_ERR or DLDO\_PSM\_ERR bit.

LDO Capacitor Detect

The analog and digital LDOs require an external decoupling capacitor of 0.1 μF. The ADFS7124-8 can check for the presence of this decoupling capacitor. Using the LDO\_CAP\_CHK bits in the ERROR\_EN register, the LDO being checked is turned off and the voltage at the LDO output is monitored. If the voltage falls, this is considered a fail and the LDO\_CAP\_ERR bit in the error register is set. Note that a missing decoupling capacitor can cause the ADC to reset. However, this is easily detectable at the system level by reading back registers.

Only the analog LDO or digital LDO can be tested for the presence of the decoupling capacitor at any one time. This test also interferes with the conversion process.

The circuitry used to check for missing decoupling capacitors can also be tested by the ADFS7124-8. When the LDO\_CAP\_CHK\_TEST\_EN bit in the ERROR\_EN register is set, the decoupling capacitor is internally disconnected from the LDO, forcing a fault condition. Therefore, when the LDO capacitor test is performed, a fault condition is reported, that is, the LDO\_CAP\_ERR bit in the error register is set.

MCLK COUNTER

A stable controller clock is important as the output data rate, filter settling time, and the filter notch frequencies are dependent on the controller clock. The ADFS7124-8 allows to monitor the controller clock. When the MCLK\_CNT\_EN bit in the ERROR\_EN register is set, the MCLK\_COUNT register increments by 1 every 131 controller clock cycles. Monitor this register over a fixed period of time. The controller clock frequency can be determined from the

## DIAGNOSTICS

result in the MCLK\_COUNT register. The MCLK\_COUNT register wraps around after it reaches its maximum value.

Note that the incrementation of the register is asynchronous to the register read. If a register read coincides with the register incrementation, it is possible to read an invalid value. To prevent this, read the register four times rather than once, then read the register four times again at a later point. By reading four values, it is possible to identify the correct register value at the start and at the end of the timing instants.

### SPI SCLK COUNTER

The SPI SCLK counter counts the number of SCLK pulses used in each read and write operation.  $\overline{CS}$  must frame every read and write operation when this function is used. All read and write operations are multiples of eight SCLK pulses (8, 16, 32, 40, 48). If the SCLK counter counts the SCLK pulses and the result is not a multiple of eight, an error is flagged; the SPI\_SCLK\_CNT\_ERR bit in the error register is set. If a write operation is being performed and the SCLK contains an incorrect number of SCLK pulses, the value is not written to the addressed register and the write operation is aborted.

The SCLK counter is enabled by setting the SPI\_SCLK\_CNT\_ERR\_EN bit in the ERROR\_EN register.

### SPI READ/WRITE ERRORS

Along with the SCLK counter, the ADFS7124-8 can also check the read and write operations to ensure that valid registers are being addressed. When the SPI\_READ\_ERR\_EN bit or the SPI\_WRITE\_ERR\_EN bit in the ERROR\_EN register are set, the ADFS7124-8 checks the address of the read/write operations. If there is an attempt to write to or read from any register other than the user registers described in this data sheet, an error is flagged; the SPI\_READ\_ERR bit or the SPI\_WRITE\_ERR bit in the error register is set and the read/write operation is aborted.

This function, along with the SCLK counter and the CRC, makes the serial interface more robust. Invalid registers are not written to or read from. An incorrect number of SCLK pulses can cause the serial interface to go asynchronous and incorrect registers to be accessed. The ADFS7124-8 protects against these issues via the diagnostics.

### SPI\_IGNORE ERROR

At certain times, the on-chip registers are not accessible. For example, during power-up, the on-chip registers are set to their default values. Wait until this operation is complete before writing to registers. Also, when offset or gain calibrations are being performed, registers cannot be accessed. If writing to registers during these busy periods, the SPI\_IGNORE\_ERR flag is set, indicating that the ADC is busy and the write operation is ignored. The SPI\_IGNORE\_ERR flag is cleared when the bit is read. This diagnostic is enabled by default. The function can be disabled using the SPI\_IGNORE\_ERR\_EN bit in the ERROR\_EN register.

## CHECKSUM PROTECTION

The ADFS7124-8 has a checksum mode that can be used to improve interface robustness. Using the checksum ensures that only valid data is written to a register and allows data read from a register to be validated. If an error occurs during a register write, the CRC\_ERR bit is set in the error register. However, to ensure that the register write was successful, read back the register and verify the checksum.

For CRC checksum calculations, the following polynomial is always used:

$$x^8 + x^2 + x + 1$$

The CRC\_ERR\_EN bit in the ERROR\_EN register enables and disables the checksum.

The checksum is appended to the end of each read and write transaction. The checksum calculation for the write transaction is calculated using the 8-bit command word and the 8-bit to 24-bit data. For a read transaction, the checksum is calculated using the command word and the 8-bit to 32-bit data output. Figure 122 and Figure 123 show SPI write and read transactions, respectively.

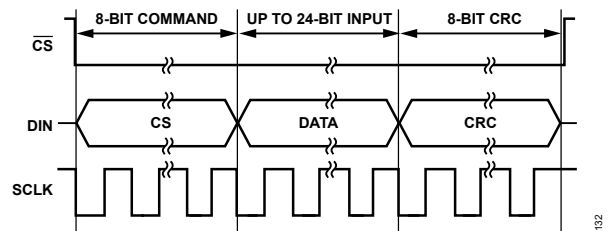

Figure 122. SPI Write Transaction with CRC

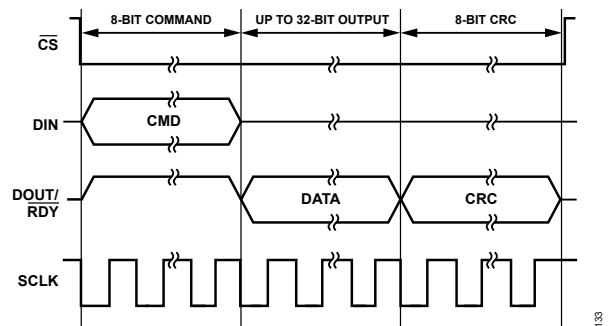

Figure 123. SPI Read Transaction with CRC

If checksum protection is enabled when continuous read mode is active, there is an implied command of 0x99 before every data transmission that must be accounted for when calculating the checksum value. This ensures a nonzero checksum value even if the ADC data equals 0x000000.

## MEMORY MAP CHECKSUM PROTECTION

For added robustness, a CRC calculation is performed on the on-chip registers as well. The status register, data register, error

## DIAGNOSTICS

register, and MCLK counter register are not included in this check because their contents change continuously. The CRC is performed at a rate of 1/2400 seconds. Each time that the memory map is accessed, the CRC is recalculated. Events that cause the CRC to be recalculated are:

- ▶ A user write.
- ▶ An offset/full-scale calibration.
- ▶ When the device is operated in the single conversion mode and the ADC goes into the standby mode following the completion of the conversion.
- ▶ When exiting the continuous read mode (the CONT\_READ bit in the ADC\_CONTROL register is set to 0).

The memory map CRC function is enabled by setting the MM\_CRC\_ERR\_EN bit in the ERROR\_EN register to 1. If an error occurs, the MM\_CRC\_ERR bit in the error register is set to 1.

### ROM CHECKSUM PROTECTION

On power-up, all registers are set to default values. These default values are held in read-only memory (ROM). For added robustness, a CRC calculation is performed on the ROM contents as well. The CRC is performed on power-up.

The ROM CRC function is enabled by setting the ROM\_CRC\_ERR\_EN bit in the ERROR\_EN register to 1. If an error occurs, the ROM\_CRC\_ERR bit in the error register is set to 1.

When this function is enabled, the internal controller clock, if enabled, remains active in the standby mode.

### CRC Calculation

The checksum, which is 8 bits wide, is generated using the polynomial

$$x^8 + x^2 + x + 1$$

To generate the checksum, the data is left shifted by eight bits to create a number ending in eight Logic 0s. The polynomial is aligned so that its MSB is adjacent to the leftmost Logic 1 of the data. An XOR (exclusive OR) function is applied to the data to produce a new, shorter number. The polynomial is again aligned so that its MSB is adjacent to the leftmost Logic 1 of the new result, and the procedure is repeated. This process is repeated until the original data is reduced to a value less than the polynomial. This is the 8-bit checksum.

### Example of a Polynomial CRC Calculation (24-Bit Word): 0x654321 (8-Bit Command and 16-Bit Data)

An example of generating the 8-bit checksum using the polynomial based checksum is as follows:

```

Initial value      011001010100001100100001
                  01100101010000110010000100000000      left shifted eight bits
x8 + x2 + x + 1 = 100000111      polynomial
100100100000110010000100000000      XOR result
100000111      polynomial
1000110001100100001000000000      XOR result
100000111      polynomial
111111100100001000000000      XOR result
100000111      polynomial value
111110111000010000000000      XOR result
100000111      polynomial value
1111000000001000000000      XOR result
100000111      polynomial value
1110011100010000000000      XOR result
100000111      polynomial value
11001001001000000000      XOR result
100000111      polynomial value
100101010100000000      XOR result
100000111      polynomial value
1011011000000000      XOR result
100000111      polynomial value
110101100000      XOR result
100000111      polynomial value
101010110000      XOR result
100000111      polynomial value
1010001000      XOR result
100000111      polynomial value
10000110      checksum = 0x86
  
```



## DIAGNOSTICS

### BURNOUT CURRENTS

The ADFS7124-8 contains two constant current generators that can be programmed to 0.5  $\mu\text{A}$ , 2  $\mu\text{A}$ , or 4  $\mu\text{A}$ . One generator sources current from  $\text{AV}_{\text{DD}}$  to  $\text{AINP}$ , and one sinks current from  $\text{AINM}$  to  $\text{AV}_{\text{SS}}$ . These currents enable open wire detection.

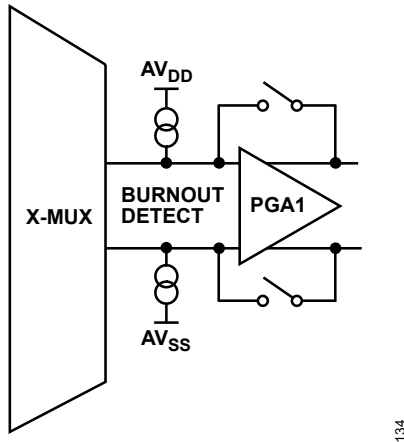

Figure 124. Burnout Currents

The currents are switched to the selected analog input pair. Both currents are either on or off. The burnout bits in the configuration register enable/disable the burnout currents along with setting the amplitude. Use these currents to verify that an external transducer is still operational before attempting to take measurements on that channel. After the burnout currents are turned on, they flow in the external transducer circuit, and a measurement of the input voltage on the analog input channel can be taken. If the resulting voltage measured is near full scale, verify why this is the case. A near full-scale reading can mean that the front-end sensor is open circuit. It can also mean that the front-end sensor is overloaded and is justified in outputting full scale, or that the reference may be absent and the  $\text{REF\_DET\_ERR}$  bit is set, thus clamping the data to all 1s.

When a conversion is close to full scale, check these three cases before making a judgment. If the voltage measured is 0 V, it may indicate that the transducer has short circuited. For normal operation, these burnout currents are turned off by setting the burnout bits to zero. The current sources work over the normal absolute input voltage range specifications with buffers on.

### TEMPERATURE SENSOR

The ADFS7124-8 has an embedded temperature sensor useful to monitor the die temperature. This is selected using the  $\text{AINP}[4:0]$  and  $\text{AINM}[4:0]$  bits in the channel register. Thus, the analog input is Temperature Sensor –  $\text{AV}_{\text{SS}}$ . Because  $\text{AINM}$  is connected to  $\text{AV}_{\text{SS}}$  for the measurement, the  $\text{AINM\_UV\_ERR}$  flag may be set when the internal temperature measurement is being performed if the flag is enabled. Therefore, ignore the  $\text{AINM\_UV\_ERR}$  flag for the temperature sensor measurement.

The sensitivity is 13,584 codes/ $^{\circ}\text{C}$ , approximately. The equation for the temperature sensor is:

$$\text{Temperature } (^{\circ}\text{C}) = ((\text{Conversion} - 0x800000)/13,584) - 272.5$$

The temperature sensor has an accuracy of  $\pm 0.5^{\circ}\text{C}$  typically.

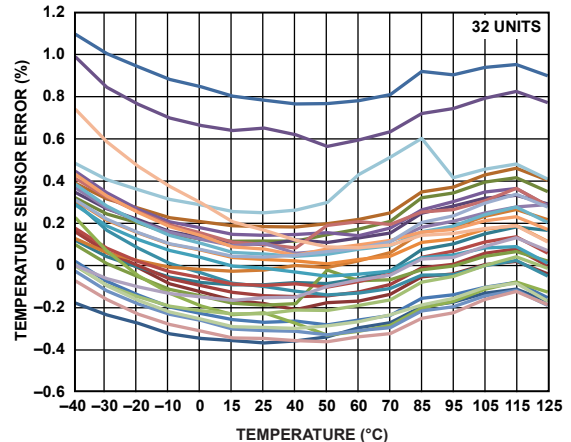

Figure 125. Temperature Sensor Error vs. Temperature



## GROUNDING AND LAYOUT

The analog inputs and reference inputs are differential and, therefore, most of the voltages in the analog modulator are common-mode voltages. The high common-mode rejection of the device removes common-mode noise on these inputs. The analog and digital supplies to the ADFS7124-8 are independent and separately pinned out to minimize coupling between the analog and digital sections of the device. The digital filter provides rejection of broadband noise on the power supplies, except at integer multiples of the controller clock frequency.

The digital filter also removes noise from the analog and reference inputs, provided that these noise sources do not saturate the analog modulator. As a result, the ADFS7124-8 is more immune to noise interference than a conventional high resolution converter. However, because the resolution of the ADFS7124-8 is high and the noise levels from the converter are so low, care must be taken with regard to grounding and layout.

The PCB that houses the ADC must be designed so that the analog and digital sections are separated and confined to certain areas of the board. A minimum etch technique is generally best for ground planes because it results in the best shielding.

In any layout, keep in mind the flow of currents in the system, ensuring that the paths for all return currents are as close as possible to the paths the currents took to reach their destinations.

Avoid running digital lines under the device because this couples noise onto the die and allows the analog ground plane to run under the ADFS7124-8 to prevent noise coupling. The power supply lines to the ADFS7124-8 must use as wide a trace as possible to provide

low impedance paths and reduce glitches on the power supply line. Shield fast switching signals like clocks with digital ground to prevent radiating noise to other sections of the board and never run clock signals near the analog inputs. Avoid crossover of digital and analog signals. Run traces on opposite sides of the board at right angles to each other. This reduces the effects of feedthrough on the board. A microstrip technique is by far the best but is not always possible with a double-sided board. In this technique, the component side of the board is dedicated to ground planes, whereas signals are placed on the solder side.

Good decoupling is important when using high resolution ADCs. The ADFS7124-8 has two power supply pins,  $AV_{DD}$  and  $IOV_{DD}$ . The  $AV_{DD}$  pin is referenced to  $AV_{SS}$ , and the  $IOV_{DD}$  pin is referenced to DGND. Decouple  $AV_{DD}$  with a 1  $\mu$ F tantalum capacitor in parallel with a 0.1  $\mu$ F capacitor to  $AV_{SS}$  on each pin. Place the 0.1  $\mu$ F capacitor as close as possible to the device on each supply, ideally right up against the device. Decouple  $IOV_{DD}$  with a 1  $\mu$ F tantalum capacitor in parallel with a 0.1  $\mu$ F capacitor to DGND. All analog inputs must be decoupled to  $AV_{SS}$ . If an external reference is used, decouple the  $REFINx(+)$  and  $REFINx(-)$  pins to  $AV_{SS}$ .

The ADFS7124-8 also has two on-board LDO regulators, one that regulates the  $AV_{DD}$  supply and one that regulates the  $IOV_{DD}$  supply. For the REGCAPA pin, it is recommended that a 0.1  $\mu$ F capacitor to  $AV_{SS}$  be used. Similarly, for the REGCAPD pin, it is recommended that a 0.1  $\mu$ F capacitor to DGND be used.

If using the ADFS7124-8 with split supply operation, a separate plane must be used for  $AV_{SS}$ .

## APPLICATIONS INFORMATION

The ADFS7124-8 offers a low cost, high resolution analog-to-digital function. Because the analog-to-digital function is provided by a  $\Sigma$ - $\Delta$  architecture, the device is more immune to noisy environments, making it ideal for use in sensor measurement, and industrial and process control applications.

### TEMPERATURE MEASUREMENT USING A THERMOCOUPLE

Figure 126 outlines a connection from a thermocouple to the ADFS7124-8. In a thermocouple application, the voltage generated by the thermocouple is measured with respect to an absolute reference; thus, the internal reference is used for this conversion. The cold junction measurement uses a ratiometric configuration, so the reference is provided externally.

Because the signal from the thermocouple is small, the ADFS7124-8 is operated with the PGA enabled to amplify the signal from the thermocouple. As the input channel is buffered, large decoupling capacitors can be placed on the front end to eliminate any noise pickup that may be present in the thermocouple leads. The bias voltage generator provides a common-mode voltage so that the voltage generated by the thermocouple is biased up to  $(AV_{DD} - AV_{SS})/2$ . For thermocouple voltages that are centered about ground, the ADFS7124-8 can be operated with a split power supply ( $\pm 1.8$  V).

The cold junction compensation is performed using a thermistor in Figure 126. The on-chip excitation current supplies the thermistor. In addition, the reference voltage for the cold junction measurement is derived from a precision resistor in series with the thermistor. This allows a ratiometric measurement so that variation of the excitation current has no effect on the measurement (it is the ratio of the precision reference resistance to the thermistor resistance that is measured).

Most conversions are read from the thermocouple, with the cold junction being read only periodically as the cold junction temperature is stable or slow moving. If a T-type thermocouple is used, it can measure a temperature from  $-200^{\circ}\text{C}$  to  $+400^{\circ}\text{C}$ . The voltage generated over this temperature range is  $-8.6$  mV to  $+17.2$  mV. The ADFS7124-8 internal reference equals 2.5 V. Therefore, the PGA is set to 128. If the thermocouple uses the AIN0/AIN1 channel and the thermistor is connected to the AIN12/AIN13 channel, the conversion process is as follows:

1. Reset the ADC.
2. Select the power mode. Set the CHANNEL\_0 register analog input to AIN0/AIN1. Assign Setup 0 to this channel. Configure Setup 0 to have a gain of 128 and select the internal reference. Select the filter type and set the output data rate.
3. Enable VBIAS on AIN0.
4. Set the CHANNEL\_1 register analog input to AIN12/AIN13. Assign Setup 1 to this channel. Configure Setup 1 to have a gain of 1 and select the external reference REFIN2( $\pm$ ). Select the filter type and set the output data rate.
5. Enable the excitation current (IOUTx) and select a suitable value. Output this current to the AIN4 pin.
6. Enable the AIN0/AIN1 channel. Wait until  $\overline{\text{RDY}}$  goes low. Read the conversion.
7. Continue to read nine further conversions from the AIN0/AIN1 channel.
8. Disable CHANNEL\_0 and enable CHANNEL\_1.
9. Wait until  $\overline{\text{RDY}}$  goes low. Read one conversion.
10. Repeat Step 5 to Step 8.

Using the linearization equation for the T-type thermocouple, process the thermocouple voltage along with the thermistor voltage and compute the actual temperature at the thermocouple head.

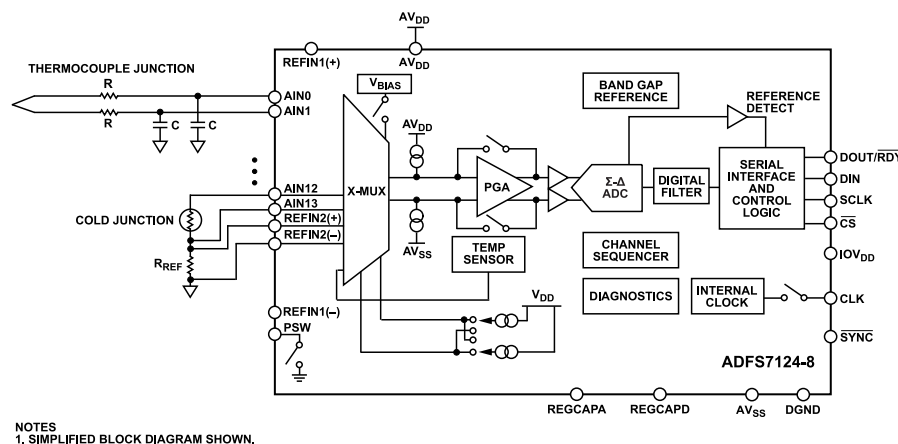

Figure 126. Thermocouple Application

## APPLICATIONS INFORMATION

The external antialias filter is omitted for clarity. However, such a filter is required to reject any interference at the modulator frequency and multiples of the modulator frequency. In addition, some filtering may be needed for EMI purposes. Both the analog inputs and reference inputs can be buffered, which allows the user to connect any RC combination to the reference or analog input pins. Note that the reference inputs require 100 mV of headroom when buffered so a headroom resistor is then needed to bias REFIN2(-) appropriately.

The required power mode depends on the performance required from the system along with the current consumption allowance for the system. In a field transmitter, low current consumption is essential. In this application, the low power mode or mid power mode is most suitable. In process control applications, power consumption is not a priority. Thus, full power mode may be selected. The full power mode offers higher throughput and lower noise.

The ADFS7124-8 on-chip diagnostics allow the user to check the circuit connections, monitor power supply, reference, and LDO voltages, check all conversions and calibrations for any errors, as well as monitor any read/write operations. In thermocouple applications, the circuit connections are verified using the reference detect and burnout currents. The REF\_DET\_ERR flag is set if the external reference REFIN2(±) is missing. The burnout currents (available in the configuration registers) detect an open wire. For example, if the thermocouple is not connected and the burnout currents are enabled on the channel, the ADC outputs a conversion that is equal to or close to full scale. For best performance, enable the burnout currents periodically to check the connections but disable them as soon as the connections are verified for they add an error to the conversions. The decoupling capacitors on the LDOs can also be checked. The ADC indicates if the capacitor is not present.

As part of the conversion process, the analog input overvoltage/undervoltage monitors are useful for detecting any excessive voltages on AINP and AINM. The power supply voltages and reference voltages are selectable as inputs to the ADC. Thus, the voltages can be periodically checked to confirm whether they are within the system specification. Also, it is possible to check that the LDO voltages are within specification. The conversion process and calibration process can also be checked. This ensures that any invalid conversions or calibrations are flagged.

Finally, the CRC check, SCLK counter, and the SPI read/write checks make the interface more robust as any read/write operation that is not valid is detected. The CRC check highlights if any bits are corrupted when being transmitted between the processor and the ADC.

### TEMPERATURE MEASUREMENT USING AN RTD

To optimize a 3-wire RTD configuration, two identically matched current sources are required. The ADFS7124-8, which contains two well matched current sources, is ideally suited to these applications. One possible 3-wire configuration is shown in [Figure 127](#). In this

3-wire configuration, the lead resistances result in errors if only one current (output at AIN0) is used, as the excitation current flows through RL1, developing a voltage error between AIN1 and AIN2. In the scheme outlined, the second RTD current source (available at AIN3) compensates for the error introduced by the excitation current flowing through RL1. The second RTD current flows through RL2. Assuming that RL1 and RL2 are equal (the leads are normally of the same material and of equal length) and that the excitation currents match, the error voltage across RL2 equals the error voltage across RL1, and no error voltage is developed between AIN1 and AIN2. Twice the voltage is developed across RL3; however, because this is a common-mode voltage it does not introduce errors. The reference voltage for the ADFS7124-8 is also generated using one of the matched current sources. It is developed using a precision resistor and applied to the differential reference pins of the ADC. This scheme ensures that the analog input voltage span remains ratiometric to the reference voltage. Any errors in the analog input voltage due to the temperature drift of the excitation current are compensated by the variation of the reference voltage.

As an example, the PT100 measures temperature from  $-200^{\circ}\text{C}$  to  $+600^{\circ}\text{C}$ . The resistance is  $100\ \Omega$  typically at  $0^{\circ}\text{C}$  and  $313.71\ \Omega$  at  $600^{\circ}\text{C}$ . If the  $500\ \mu\text{A}$  excitation currents are used, the maximum voltage generated across the RTD when using the full temperature range of the RTD is:

$$500\ \mu\text{A} \times 313.71\ \Omega = 156.86\ \text{mV}$$

This is amplified to 2.51 V within the ADFS7124-8 if the gain is programmed to 16.

The voltage generated across the reference resistor must be at least 2.51 V. Therefore, the reference resistor value must equal at least:

$$2.51\ \text{V}/500\ \mu\text{A} = 5020\ \Omega$$

Therefore, a 5.11 k $\Omega$  resistor can be used.

$$5.11\ \text{k}\Omega \times \text{Excitation Current} = 5.11\ \text{k}\Omega \times 500\ \mu\text{A} = 2.555\ \text{V}$$

One other consideration is the output compliance. The output compliance equals  $\text{AV}_{\text{DD}} - 0.37\ \text{V}$ . If a 3.3 V analog supply is used, the voltage at AIN0 must be less than  $(3.3\ \text{V} - 0.37\ \text{V}) = 2.93\ \text{V}$ . From the previous calculations, this specification is met because the maximum voltage at AIN0 equals the voltage across the reference resistor plus the voltage across the RTD, which equals:

$$2.555\ \text{V} + 156.86\ \text{mV} = 2.712\ \text{V}$$

A typical procedure for reading the RTD is as follows:

1. Reset the ADC.
2. Select the power mode.
3. Set the CHANNEL\_0 register analog input to AIN1/AIN2. Assign Setup 0 to this channel. Configure Setup 0 to have a gain of 16 and select the reference source REFIN2(±). Select the filter type and set the output data rate.

APPLICATIONS INFORMATION

4. Program the excitation currents to 500  $\mu$ A and output the currents on the AIN0 and AIN3 pins.
5. Wait until  $\overline{\text{RDY}}$  goes low. Read the conversion value.
6. Repeat Step 4.

In the processor, implement the linearization routine for the PT100.

The external antialias filter is omitted for clarity. However, such a filter is required to reject any interference at the modulator frequency and multiples of the modulator frequency. Also, some filtering may be needed for EMI purposes. Both the analog inputs and reference inputs can be buffered, which allows the user to connect any RC combination to the reference or analog input pins.

On the ADFS7124-8, the excitation currents can be made available at the input pins, for example, the AIN3 pin can function as an analog input as well as outputting the current source. This option allows multiple sensors to be connected to the ADC using a minimum pin count. However, the resistor of the antialiasing filter is in series with the RTD. This introduces an error in the conversions as there is a voltage generated across the antialiasing resistor. To minimize the error, minimize the resistance of the antialiasing filter.

The power mode to use depends on the performance required from the system along with the current consumption allowance for the system. In a field transmitter, low current consumption is essential. In this application, the low power mode or mid power mode is most suitable. In process control applications, power consumption is not a priority. Thus, full power mode may be selected. The full power mode offers higher throughput and lower noise.

The ADFS7124-8 on-chip diagnostics allow the user to check the circuit connections, monitor the power supply, reference, and LDO voltages, check all conversions and calibrations for any errors, as well as monitor any read/write operations. In RTD applications, the circuit connections are verified using the reference detect and the burnout currents. The REF\_DET\_ERR flag is set if the external reference REFIN2( $\pm$ ) is missing. The burnout currents (available in the configuration registers) detect an open wire. The decoupling capacitors on the LDOs can also be checked. The ADC indicates if the capacitor is not present.

As part of the conversion process, the analog input overvoltage/undervoltage monitors are useful to detect any excessive voltages on AINP and AINM. The power supply voltages and reference voltages are selectable as inputs to the ADC. Thus, the voltages can be periodically checked to confirm whether they are within the system specification. Also, it is possible to check that the LDO voltages are within specification. The conversion process and calibration process can also be checked. This ensures that any invalid conversions or calibrations are flagged.

Finally, the CRC check, SCLK counter, and the SPI read/write checks make the interface more robust as any read/write operation that is not valid is detected. The CRC check highlights if any bits are corrupted when being transmitted between the processor and the ADC.

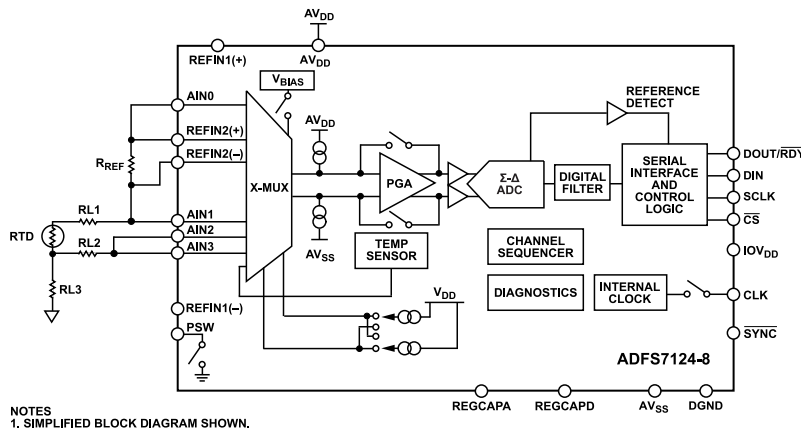

Figure 127. 3-Wire RTD Application

## APPLICATIONS INFORMATION

### FLOWMETER

Figure 128 shows the ADFS7124-8 being used in a flowmeter application that consists of two pressure transducers, with the rate of flow being equal to the pressure difference. The pressure transducers are arranged in a bridge network and give a differential output voltage between its OUT+ and OUT- terminals. With rated full-scale pressure (in this case, 300 mmHg) on the transducer, the differential output voltage is 3 mV/V of the input voltage (that is, the voltage between the IN+ and IN- terminals).

Assuming a 3 V excitation voltage, the full-scale output range from the transducer is 9 mV. The excitation voltage for the bridge can directly provide the reference for the ADC, as the reference input range includes the supply voltage.

A second advantage of using the ADFS7124-8 in transducer-based applications is that the low-side power switch can be fully utilized in low power applications. The low-side power switch is connected in series with the cold side of the bridges. In normal operation, the switch is closed and measurements are taken. In applications where power is of concern, the ADFS7124-8 can be placed in the standby mode, thus significantly reducing the power consumed in the application. In addition, the low-side power switch can be opened while in the standby mode, thus avoiding unnecessary power consumption by the front-end transducers. When the device is taken out of the standby mode, and the low-side power switch is closed, ensure that the front-end circuitry is fully settled before attempting a read from the ADFS7124-8. The power switch can be closed before taking the device out of standby, if needed. This allows time for the sensor to power up and settle before the ADC powers up and begins sampling the analog input.

In the diagram, temperature compensation is performed using a thermistor. The on-chip excitation current supplies the thermistor. In addition, the reference voltage for the temperature measurement is derived from a precision resistor in series with the thermistor. This allows a ratiometric measurement so that variation of the excitation current has no effect on the measurement (it is the ratio of the precision reference resistance to the thermistor resistance that is measured).

If the sensor sensitivity is 3 mV/V and the excitation voltage is 3 V, the maximum output from the sensor is 9 mV. The ADFS7124-8 PGA can be set to 128 to amplify the sensor signal.

The ADFS7124-8 PGA amplifies the signal to:

$$9 \text{ mV} \times 128 = 1.152 \text{ V}$$

This value does not exceed the reference voltage (3 V).

A typical procedure for reading the sensors is as follows:

1. Reset the ADC.
2. Select the power mode.
3. Set the CHANNEL\_0 register analog input to AIN0/AIN1. Assign Setup 0 to this channel. Configure Setup 0 to have a gain

of 128 and select the reference source to REFIN1(±). Select the filter type and set the output data rate.

4. Set the CHANNEL\_1 register analog input to AIN2/AIN3. Assign Setup 0 to this channel (both channels use the same setup).
5. Set the CHANNEL\_2 register analog input to AIN4/AIN5. Assign Setup 1 to this channel. Configure Setup 1 to have a gain of 1 and select the reference source REFIN2(±). Select the filter type and set the output data rate.
6. Program the excitation current and output the current on the AIN4 pin.
7. Enable both CHANNEL\_0 and CHANNEL\_1. Enable the DATA\_STATUS bit to identify the channel from which the conversion originated. The ADC automatically sequences through these channels.
8. Wait until  $\overline{\text{RDY}}$  goes low. Read the conversion value.
9. Repeat Step 8 until the temperature is to be read (every 10 conversions of the pressure sensor readings, for example).
10. Disable CHANNEL\_0 and CHANNEL\_1. Enable CHANNEL\_2.
11. Wait until  $\overline{\text{RDY}}$  goes low. Read the conversion.
12. Repeat Step 6 to Step 10.

In the processor, the conversion information is converted to pressure and the flow rate can be calculated. The processor typically contains a lookup table for each pressure sensor so its variation with temperature can be compensated.

The external antialias filter is omitted for clarity. However, such a filter is required to reject any interference at the modulator frequency and multiples of the modulator frequency. Also, some filtering may be needed for EMI purposes. Both the analog inputs and reference inputs can be buffered, which allows the user to connect any RC combination to the reference or analog input pins. Note that the reference inputs require 100mV of headroom when buffered so headroom resistors are then required.

The power mode to use depends on the performance required from the system along with the current consumption allowance for the system. In a field transmitter, low current consumption is essential. In this application, low power mode or mid power mode is most suitable. In process control applications, power consumption is not a priority. Thus, full power mode may be selected. Full power mode offers higher throughput and lower noise.

The ADFS7124-8 on-chip diagnostics allow the user to check the circuit connections, monitor power supply, reference, and LDO voltages, check all conversions and calibrations for any errors, as well as monitor any read/write operations. The REF\_DET\_ERR flag is set if the external reference REFIN2(±) or REFIN1(±) is missing. The decoupling capacitors on the LDOs can also be checked. The ADC indicates if the capacitor is not present.

As part of the conversion process, the analog input overvoltage/undervoltage monitors are useful to detect any excessive voltages on AINP and AINM. The power supply voltages and reference



**APPLICATIONS INFORMATION**

voltages are selectable as inputs to the ADC. Thus, the voltages can be periodically checked to confirm whether they are within the system specification. In addition, it is possible to check that the LDO voltages are within specification. The conversion process and calibration process can also be checked. This ensures that any invalid conversions or calibrations are flagged.

Finally, the CRC check, SCLK counter, and the SPI read/write checks make the interface more robust as any read/write operation that is not valid is detected. The CRC check highlights if any bits are corrupted when being transmitted between the processor and the ADC.

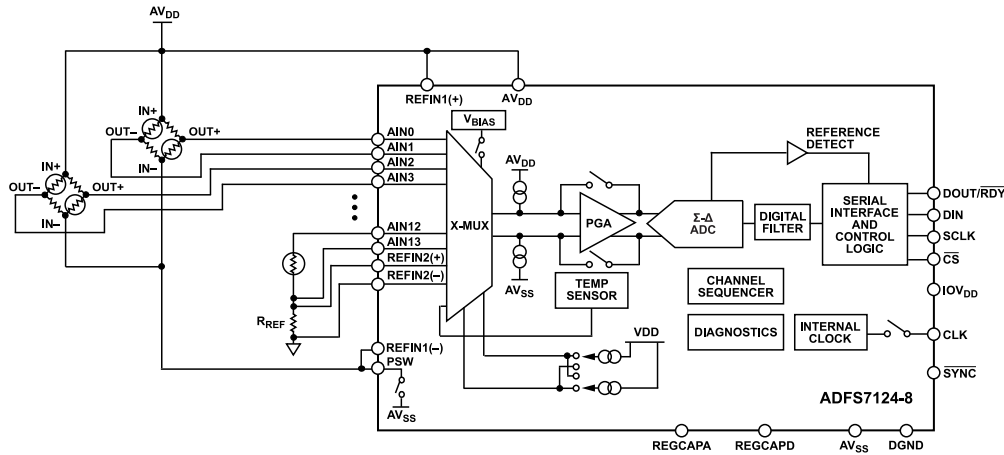

NOTES  
1. SIMPLIFIED BLOCK DIAGRAM SHOWN.

108

**Figure 128. Flowmeter Application**

## ON-CHIP REGISTERS

The ADC is controlled and configured through a number of on-chip registers described in the following sections. In the following descriptions, 'set' implies a Logic 1 state and 'cleared' implies a Logic 0 state, unless otherwise noted.

Table 63. Register Summary

Addr.	Name	Bit 7	Bit 6	Bit 5	Bit 4	Bit 3	Bit 2	Bit 1	Bit 0	Reset	RW	
0x00	COMMS	WEN	R/W	RS[5:0]						0x00	W	
0x00	Status	RDY	ERROR_FLAG	0	POR_FLAG	CH_ACTIVE				0x00	R	
0x01	ADC_CONTROL	0			DOUT_RDY_DEL	CONT_READ	DATA_STATUS	CS_EN	REF_EN	0x0000	RW	
		POWER_MODE		Mode			CLK_SEL					
0x02	Data	Data [23:16]								0x000000	R	
		Data [15:8]										
		Data [7:0]										
0x03	IO_CONTROL_1	GPIO_DAT4	GPIO_DAT3	GPIO_DAT2	GPIO_DAT1	GPIO_CTRL4	GPIO_CTRL3	GPIO_CTRL2	GPIO_CTRL1	0x000000	RW	
		PDSW	0	IOUT1			IOUT0					
		IOUT1_CH				IOUT0_CH						
0x04	IO_CONTROL_2	VBIAS15	VBIAS14	VBIAS13	VBIAS12	VBIAS11	VBIAS10	VBIAS9	VBIAS8	0x0000	RW	
		VBIAS7	VBIAS6	VBIAS5	VBIAS4	VBIAS3	VBIAS2	VBIAS1	VBIAS0			
0x05	ID	DEVICE_ID				SILICON_REVISION				0x17	R	
0x06	Error	0				LDO_CAP_ERR	ADC_CAL_ERR	ADC_CONV_ERR	ADC_SAT_ERR	0x000000	R	
		AINP_OV_ERR	AINP_UV_ERR	AINM_OV_ERR	AINM_UV_ERR	REF_DET_ERR	0	DLDO_PSM_ERR	0			
		ALDO_PSM_ERR	SPI_IGNORE_ERR	SPI_SCLK_CNT_ERR	SPI_READ_ERR	SPI_WRITE_ERR	SPI_CRC_ERR	MM_CRC_ERR	ROM_CRC_ERR			
0x07	ERROR_EN	0	MCLK_CNT_EN	LDO_CAP_CHK_TEST_EN	LDO_CAP_CHK		ADC_CAL_ERR_EN	ADC_CONV_ERR_EN	ADC_SAT_ERR_EN	0x000040	RW	
		AINP_OV_ERR_EN	AINP_UV_ERR_EN	AINM_OV_ERR_EN	AINM_UV_ERR_EN	REF_DET_ERR_EN	DLDO_PSM_TRIP_TEST_EN	DLDO_PSM_ERR_EN	ALDO_PSM_TRIP_TEST_EN			
		ALDO_PSM_ERR_EN	SPI_IGNORE_ERR_EN	SPI_SCLK_CNT_ERR_EN	SPI_READ_ERR_EN	SPI_WRITE_ERR_EN	SPI_CRC_ERR_EN	MM_CRC_ERR_EN	ROM_CRC_ERR_EN			
0x08	MCLK_COUNT	MCLK_COUNT								0x00	R	
0x09 to 0x18	CHANNEL_0 to CHANNEL_15	Enable	Setup			0		AINP[4:3]		0x8001 <sup>1</sup>	RW	
		AINP[2:0]			AINM[4:0]							
0x19 to 0x20	CONFIG_0 to CONFIG_7	0				Bipolar		Burnout		REF_BUF_P	0x0860	RW
		REF_BUF_M	AIN_BUF_P	AIN_BUF_M	REF_SEL		PGA					
0x21 to 0x28	FILTER_0 to FILTER_7	Filter			REJ60	POST_FILTER			SINGLE_CYCLE	0x060180	RW	
		0				FS[10:8]						
		FS[7:0]										
0x29 to 0x30	OFFSET_0 to OFFSET_7	Offset [23:16]								0x800000	RW	
		Offset [15:8]										
		Offset [7:0]										

## ON-CHIP REGISTERS

Table 63. Register Summary (Continued)

Addr.	Name	Bit 7	Bit 6	Bit 5	Bit 4	Bit 3	Bit 2	Bit 1	Bit 0	Reset	RW
0x31 to 0x38	GAIN_0 to GAIN_7					Gain [23:16]				0x5XXXX X	RW
						Gain [15:8]					
						Gain [7:0]					

<sup>1</sup> CHANNEL\_0 is reset to 0x8001. All other channels are reset to 0x0001.

## COMMUNICATIONS REGISTER

RS[5:0] = 0, 0, 0, 0, 0

The communications register is an 8-bit, write only register. All communications to the device must start with a write operation to the communications register. The data written to the communications register determines whether the next operation is a read or write operation, and to which register this operation takes place, the RS[5:0] bits selecting the register to be accessed.

For read or write operations, after the subsequent read or write operation to the selected register is complete, the interface returns to where it expects a write operation to the communications register. This is the default state of the interface and, on power-up or after a reset, the ADC is in this default state waiting for a write operation to the communications register.

In situations where the interface sequence is lost, a write operation of at least 64 serial clock cycles with DIN high returns the ADC to this default state by resetting the entire device. Table 64 outlines the bit designations for the communications register. Bit 7 denotes the first bit of the data stream.

Bit 7	Bit 6	Bit 5	Bit 4	Bit 3	Bit 2	Bit 1	Bit 0
WEN (0)	R/W (0)				RS[5:0] (0)		

Table 64. Communications Register Bit Descriptions

Bits	Bit Name	Description
7	WEN	Write enable bit. A 0 must be written to this bit so that the write to the communications register actually occurs. If a 1 is the first bit written, the device does not clock on to subsequent bits in the register. It stays at this bit location until a 0 is written to this bit. As soon as a 0 is written to the WEN bit, the next seven bits are loaded to the communications register.
6	R/W	A 0 in this bit location indicates that the next operation is a write to a specified register. A 1 in this position indicates that the next operation is a read from the designated register.
5:0	RS[5:0]	Register address bits. These address bits select which registers of the ADC are being selected during this serial interface communication. See Table 63.

## STATUS REGISTER

RS[5:0] = 0, 0, 0, 0, 0

Power-On/Reset = 0x00

The status register is an 8-bit, read only register. To access the ADC status register, write to the communications register, select the next operation to be read, and set the register address bits RS[5:0] to 0.

Table 65 outlines the bit designations for the status register. Bit 7 denotes the first bit of the data stream. The number in parentheses indicates the power-on/reset default status of that bit.

Bit 7	Bit 6	Bit 5	Bit 4	Bit 3	Bit 2	Bit 1	Bit 0
RDY (0)	ERROR_FLAG (0)	0 (0)	POR_FLAG (0)			CH_ACTIVE (0)	

Table 65. Status Register Bit Descriptions

Bits	Bit Name	Description
7	RDY	Ready bit for the ADC. This bit is cleared when data is written to the ADC data register. The RDY bit is set automatically after the ADC data register is read or a period of time before the data register is updated with a new conversion result to indicate not to read the conversion



## ON-CHIP REGISTERS

Table 65. Status Register Bit Descriptions (Continued)

Bits	Bit Name	Description
6	ERROR_FLAG	data. It is also set when the device is placed in the power-down or standby mode. The end of a conversion is also indicated by the DOUT/RDY pin. This pin can be used as an alternative to the status register for monitoring the ADC for conversion data. ADC error bit. This bit indicates if one of the error bits is asserted in the error register. This bit is high if one or more of the error bits in the error register is set. This bit is cleared by a read of the error register.
5	0	This bit is set to 0.
4	POR_FLAG	Power-on reset flag. This bit indicates that a power-on reset occurred. A power-on reset occurs on power-up, when the power supply voltage goes below a threshold voltage, when a reset is performed, and when coming out of power-down mode. The status register must be read to clear the bit.
3:0	CH_ACTIVE	These bits indicate which channel is being converted by the ADC. 0000 = Channel 0. 0001 = Channel 1. 0010 = Channel 2. 0011 = Channel 3. 0100 = Channel 4. 0101 = Channel 5. 0110 = Channel 6. 0111 = Channel 7. 1000 = Channel 8. 1001 = Channel 9. 1010 = Channel 10. 1011 = Channel 11. 1100 = Channel 12. 1101 = Channel 13. 1110 = Channel 14. 1111 = Channel 15.

## ADC\_CONTROL REGISTER

RS[5:0] = 0, 0, 0, 0, 0, 1

Power-On/Reset = 0x0000

Table 66 outlines the bit designations for the register. Bit 15 is the first bit of the data stream. The number in parentheses indicates the power-on/reset default status of that bit.

Bit 7	Bit 6	Bit 5	Bit 4	Bit 3	Bit 2	Bit 1	Bit 0
0 (0)	0 (0)	0 (0)	DOUT_RDY_DEL (0)	CONT_READ (0)	DATA_STATUS (0)	CS_EN (0)	REF_EN (0)
POWER_MODE (0)		Mode (0)				CLK_SEL (0)	

Table 66. ADC Control Register Bit Descriptions

Bits	Bit Name	Description
15:13	0	These bits must be programmed with a Logic 0 for correct operation.
12	DOUT_RDY_DEL	Controls the SCLK inactive edge to DOUT/RDY high time. When DOUT_RDY_DEL is cleared, the delay is 10 ns minimum. When DOUT_RDY_DEL is set, the delay is increased to 100 ns minimum. This function is useful when CS is tied low (the CS_EN bit is set to 0).
11	CONT_READ	Continuous read of the data register. When this bit is set to 1 (and the data register is selected), the serial interface is configured so that the data register can be continuously read; that is, the contents of the data register are automatically placed on the DOUT pin when the SCLK pulses are applied after the RDY pin goes low to indicate that a conversion is complete. The communications register does not have to be written to for subsequent data reads. To enable continuous read, the CONT_READ bit is set. To disable continuous read, write a read data command while the DOUT/RDY pin is low. While continuous read is enabled, the ADC monitors activity on the DIN line so that it can receive the instruction to disable continuous read. Additionally, a reset occurs if 64 consecutive 1s occur on DIN; therefore, hold DIN low until an instruction is written to the device.

## ON-CHIP REGISTERS

Table 66. ADC Control Register Bit Descriptions (Continued)

Bits	Bit Name	Description
10	DATA_STATUS	This bit enables the transmission of the status register contents after each data register read. When DATA_STATUS is set, the contents of the status register are transmitted along with each data register read. This function is useful when several channels are selected because the status register identifies the channel to which the data register value corresponds.
9	CS_EN	This bit controls the operation of the DOUT/RDY pin during read operations. When CS_EN is cleared, the DOUT pin returns to being a RDY pin within nanoseconds of the SCLK inactive edge (the delay is determined by the DOUT_RDY_DEL bit). When set, the DOUT/RDY pin continues to output the LSB of the register being read until CS is taken high. CS must frame all read operations when CS_EN is set. CS_EN must be set to use the diagnostic functions SPI_WRITE_ERR, SPI_READ_ERR, and SPI_SCLK_CNT_ERR.
8	REF_EN	Internal reference voltage enable. When this bit is set, the internal reference is enabled and available at the REFOUT pin. When this bit is cleared, the internal reference is disabled.
7:6	POWER_MODE	Power Mode Select. These bits select the power mode. The current consumption and output data rate ranges are dependent on the power mode. 00 = low power. 01 = mid power. 10 = full power. 11 = full power.
5:2	Mode	These bits control the mode of operation for ADC. See Table 67.
1:0	CLK_SEL	These bits select the clock source for the ADC. Either the on-chip 614.4 kHz clock can be used or an external clock can be used. The ability to use an external clock allows several ADFS7124-8 devices to be synchronized. Also, 50 Hz and 60 Hz rejection is improved when an accurate external clock drives the ADC. 00 = internal 614.4 kHz clock. The internal clock is not available at the CLK pin. 01 = internal 614.4 kHz clock. This clock is available at the CLK pin. 10 = external 614.4 kHz clock. 11 = external clock. The external clock is divided by 4 within the ADFS7124-8.

Table 67. Operating Modes

Mode Value	Description
0000	Continuous conversion mode (default). In the continuous conversion mode, the ADC continuously performs conversions and places the result in the data register. RDY goes low when a conversion is complete. Read these conversions by placing the device in the continuous read mode, whereby the conversions are automatically placed on the DOUT line when SCLK pulses are applied. Alternatively, instruct the ADC to output the conversion by writing to the communications register. After power-on, a reset, or a reconfiguration of the ADC, the complete settling time of the filter is required to generate the first valid conversion. Subsequent conversions are available at the selected output data rate, which is dependent on filter choice.
0001	Single conversion mode. When the single conversion mode is selected, the ADC powers up and performs a single conversion on the selected channel. The conversion requires the complete settling time of the filter. The conversion result is placed in the data register, RDY goes low, and the ADC returns to the standby mode. The conversion remains in the data register and RDY remains active (low) until the data is read or another conversion is performed.
0010	Standby mode. In the standby mode, all sections of the ADFS7124-8 can be powered down except the LDOs. The internal reference, on-chip oscillator, low-side power switch, and bias voltage generator can be enabled or disabled while in the standby mode. The on-chip registers retain their contents in the standby mode. Any enabled diagnostics remain active when the ADC is in the standby mode. The diagnostics can be enabled/disabled while in the standby mode. However, any diagnostics that require the controller clock (reference detect, undervoltage/overvoltage detection, LDO trip tests, memory map CRC, and MCLK counter) must be enabled when the ADC is in the continuous conversion mode or idle mode; these diagnostics do not function if enabled in the standby mode.
0011	Power-down mode. In the power-down mode, all the ADFS7124-8 circuitry is powered down, including the current sources, power switch, burnout currents, bias voltage generator, and clock circuitry. The LDOs are also powered down. In the power-down mode, the on-chip registers do not retain their contents. Therefore, coming out of power-down mode, all registers must be reprogrammed.
0100	Idle mode. In the idle mode, the ADC filter and modulator are held in a reset state even though the modulator clocks continue to be provided.
0101	Internal zero-scale (offset) calibration. An internal short is automatically connected to the input. RDY goes high when the calibration is initiated and returns low when the calibration is complete. The ADC is placed in the idle mode following a calibration. The measured offset coefficient is placed in the offset register of the selected channel. Select only one channel when zero-scale calibration is being performed. An internal zero-scale calibration takes a time of one settling period to be performed.
0110	Internal full-scale (gain) calibration. A full-scale input voltage is automatically connected to the selected analog input for this calibration. RDY goes high when the calibration is initiated and returns low when the calibration is complete. The ADC is placed in the idle mode following a calibration. The measured full-scale coefficient is placed in the gain register of the selected channel. A full-scale calibration is required each time the gain of a channel is changed to minimize the

## ON-CHIP REGISTERS

Table 67. Operating Modes (Continued)

Mode Value	Description
	full-scale error. Select only one channel when full-scale calibration is being performed. The ADFS7124-8 is factory calibrated at a gain of 1. Further internal full-scale calibrations at a gain of 1 are not supported. An internal full-scale calibration (gain > 1) takes a time of four settling periods. Internal full-scale calibrations cannot be performed in the full power mode. So, if using the full-power mode, select mid or low power mode for the internal full-scale calibration. This calibration is valid in the full power mode as the same reference and gain are used. When performing internal zero-scale and internal full-scale calibrations, the internal full-scale calibration must be performed before the internal zero-scale calibration. Therefore, write 0x800000 to the offset register before performing any internal full-scale calibration, which resets the offset register to its default value.
0111	System zero-scale (offset) calibration. Connect the system zero-scale input to the channel input pins of the selected channel. $\overline{RDY}$ goes high when the calibration is initiated and returns low when the calibration is complete. The ADC is placed in the idle mode following a calibration. The measured offset coefficient is placed in the offset register of the selected channel. A system zero-scale calibration is required each time the gain of a channel is changed. Select only one channel when full-scale calibration is being performed. A system zero-scale calibration takes a time of one settling period to be performed.
1000	System full-scale (gain) calibration. Connect the system full-scale input to the channel input pins of the selected channel. $\overline{RDY}$ goes high when the calibration is initiated and returns low when the calibration is complete. The ADC is placed in the idle mode following a calibration. The measured full-scale coefficient is placed in the gain register of the selected channel. A full-scale calibration is required each time the gain of a channel is changed. Select only one channel when full-scale calibration is being performed. A system full-scale calibration takes a time of one settling period to be performed.
1001 to 1111	Reserved.

## DATA REGISTER

RS[5:0] = 0, 0, 0, 0, 1, 0

Power-On/Reset = 0x000000

The conversion result from the ADC is stored in this data register. This is a read-only register. On completion of a read operation from this register, the  $\overline{RDY}$  bit/pin is set.

## IO\_CONTROL\_1 REGISTER

RS[5:0] = 0, 0, 0, 0, 1, 1 Power-On/Reset = 0x000000

Table 68 outlines the bit designations for the register. Bit 23 is the first bit of the data stream. The number in parentheses indicates the power-on/reset default status of that bit.

Bit 7	Bit 6	Bit 5	Bit 4	Bit 3	Bit 2	Bit 1	Bit 0
GPIO_DAT4 (0)	GPIO_DAT3 (0)	GPIO_DAT2 (0)	GPIO_DAT1 (0)	GPIO_CTRL4 (0)	GPIO_CTRL3 (0)	GPIO_CTRL2 (0)	GPIO_CTRL1 (0)
PDSW (0)	0 (0)	IOUT1 (0)			IOUT0 (0)		
IOUT1_CH (0)				IOUT0_CH (0)			

Table 68. IO\_CONTROL\_1 Register Bit Descriptions

Bits	Bit Name	Description
23	GPIO_DAT4	Digital Output P4. When GPIO_CTRL4 is set, the GPIO_DAT4 bit sets the value of the P4 general-purpose output pin. When GPIO_DAT4 is high, the P4 output pin is high. When GPIO_DAT4 is low, the P4 output pin is low.
22	GPIO_DAT3	Digital Output P3. When GPIO_CTRL3 is set, the GPIO_DAT3 bit sets the value of the P3 general-purpose output pin. When GPIO_DAT3 is high, the P3 output pin is high. When GPIO_DAT3 is low, the P3 output pin is low.
21	GPIO_DAT2	Digital Output P2. When GPIO_CTRL2 is set, the GPIO_DAT2 bit sets the value of the P2 general-purpose output pin. When GPIO_DAT2 is high, the P2 output pin is high. When GPIO_DAT2 is low, the P2 output pin is low.
20	GPIO_DAT1	Digital Output P1. When GPIO_CTRL1 is set, the GPIO_DAT1 bit sets the value of the P1 general-purpose output pin. When GPIO_DAT1 is high, the P1 output pin is high. When GPIO_DAT1 is low, the P1 output pin is low.
19	GPIO_CTRL4	Digital Output P4 enable. When GPIO_CTRL4 is set, the digital output P4 is active. When GPIO_CTRL4 is cleared, the pin functions as analog input pin AIN5.
18	GPIO_CTRL3	Digital Output P3 enable. When GPIO_CTRL3 is set, the digital output P3 is active. When GPIO_CTRL3 is cleared, the pin functions as analog input pin AIN4.
17	GPIO_CTRL2	Digital Output P2 enable. When GPIO_CTRL2 is set, the digital output P2 is active. When GPIO_CTRL2 is cleared, the pin functions as analog input pin AIN3.

## ON-CHIP REGISTERS

Table 68. IO\_CONTROL\_1 Register Bit Descriptions (Continued)

Bits	Bit Name	Description
16	GPIO_CTRL1	Digital Output P1 enable. When GPIO_CTRL1 is set, the digital output P1 is active. When GPIO_CTRL1 is cleared, the pin functions as analog input pin AIN2.
15	PDSW	Bridge power-down switch control bit. Set this bit to close the bridge power-down switch PDSW to AGND. The switch can sink up to 30 mA. Clear this bit to open the bridge power-down switch. When the ADC is placed in standby mode, the bridge power-down switch remains active.
14	0	This bit must be programmed with a Logic 0 for correct operation.
13:11	IOUT1	These bits set the value of the excitation current for IOUT1. 000 = off. 001 = 50 $\mu$ A. 010 = 100 $\mu$ A 011 = 250 $\mu$ A. 100 = 500 $\mu$ A. 101 = 750 $\mu$ A. 110 = 1000 $\mu$ A 111 = 0.1 $\mu$ A.
10:8	IOUT0	These bits set the value of the excitation current for IOUT0. 000 = off. 001 = 50 $\mu$ A. 010 = 100 $\mu$ A 011 = 250 $\mu$ A. 100 = 500 $\mu$ A. 101 = 750 $\mu$ A. 110 = 1000 $\mu$ A 111 = 0.1 $\mu$ A.
7:4	IOUT1_CH	Channel select bits for the excitation current for IOUT1. 0000 = IOUT1 is available on the AIN0 pin. 0001 = IOUT1 is available on the AIN1 pin. 0010 = IOUT1 is available on the AIN2 pin. 0011 = IOUT1 is available on the AIN3 pin. 0100 = IOUT1 is available on the AIN4 pin. 0101 = IOUT1 is available on the AIN5 pin. 0110 = IOUT1 is available on the AIN6 pin. 0111 = IOUT1 is available on the AIN7 pin. 1000 = IOUT1 is available on the AIN8 pin. 1001 = IOUT1 is available on the AIN9 pin. 1010 = IOUT1 is available on the AIN10 pin. 1011 = IOUT1 is available on the AIN11 pin. 1100 = IOUT1 is available on the AIN12 pin. 1101 = IOUT1 is available on the AIN13 pin. 1110 = IOUT1 is available on the AIN14 pin. 0111 = IOUT1 is available on the AIN15 pin.
3:0	IOUT0_CH	Channel select bits for the excitation current for IOUT0. 0000 = IOUT0 is available on the AIN0 pin. 0001 = IOUT0 is available on the AIN1 pin. 0010 = IOUT0 is available on the AIN2 pin. 0011 = IOUT0 is available on the AIN3 pin. 0100 = IOUT0 is available on the AIN4 pin. 0101 = IOUT0 is available on the AIN5 pin. 0110 = IOUT0 is available on the AIN6 pin.

## ON-CHIP REGISTERS

**Table 68. IO\_CONTROL\_1 Register Bit Descriptions (Continued)**

Bits	Bit Name	Description
		0111 = IOUT0 is available on the AIN7 pin. 1000 = IOUT0 is available on the AIN8 pin. 1001 = IOUT0 is available on the AIN9 pin. 1010 = IOUT0 is available on the AIN10 pin. 1011 = IOUT0 is available on the AIN11 pin. 1100 = IOUT0 is available on the AIN12 pin. 1101 = IOUT0 is available on the AIN13 pin. 1110 = IOUT0 is available on the AIN14 pin. 1111 = IOUT0 is available on the AIN15 pin.

### IO\_CONTROL\_2 REGISTER

**RS[5:0] = 0, 0, 0, 1, 0, 0**

**Power-On/Reset = 0x0000**

Table 69 outlines the bit designations for the register. Bit 15 is the first bit of the data stream. The number in parentheses indicates the power-on/reset default status of that bit. The internal bias voltage can be enabled on multiple channels.

Bit 7	Bit 6	Bit 5	Bit 4	Bit 3	Bit 2	Bit 1	Bit 0
VBIAS15 (0)	VBIAS14 (0)	VBIAS13 (0)	VBIAS12 (0)	VBIAS11 (0)	VBIAS10 (0)	VBIAS9 (0)	VBIAS8 (0)
VBIAS7 (0)	VBIAS6 (0)	VBIAS5 (0)	VBIAS4 (0)	VBIAS3 (0)	VBIAS2 (0)	VBIAS1 (0)	VBIAS0 (0)

**Table 69. IO\_CONTROL\_2 Register Bit Descriptions**

Bits	Bit Name	Description
15	VBIAS15	Enable the bias voltage on the AIN15 channel. When set, the internal bias voltage is available on AIN15.
14	VBIAS14	Enable the bias voltage on the AIN14 channel. When set, the internal bias voltage is available on AIN14.
13	VBIAS13	Enable the bias voltage on the AIN13 channel. When set, the internal bias voltage is available on AIN13.
12	VBIAS12	Enable the bias voltage on the AIN12 channel. When set, the internal bias voltage is available on AIN12.
11	VBIAS11	Enable the bias voltage on the AIN11 channel. When set, the internal bias voltage is available on AIN11.
10	VBIAS10	Enable the bias voltage on the AIN10 channel. When set, the internal bias voltage is available on AIN10.
9	VBIAS9	Enable the bias voltage on the AIN9 channel. When set, the internal bias voltage is available on AIN9.
8	VBIAS8	Enable the bias voltage on the AIN8 channel. When set, the internal bias voltage is available on AIN8.
7	VBIAS7	Enable the bias voltage on the AIN7 channel. When set, the internal bias voltage is available on AIN7.
6	VBIAS6	Enable the bias voltage on the AIN6 channel. When set, the internal bias voltage is available on AIN6.
5	VBIAS5	Enable the bias voltage on the AIN5 channel. When set, the internal bias voltage is available on AIN5.
4	VBIAS4	Enable the bias voltage on the AIN4 channel. When set, the internal bias voltage is available on AIN4.
3	VBIAS3	Enable the bias voltage on the AIN3 channel. When set, the internal bias voltage is available on AIN3.
2	VBIAS2	Enable the bias voltage on the AIN2 channel. When set, the internal bias voltage is available on AIN2.
1	VBIAS1	Enable the bias voltage on the AIN1 channel. When set, the internal bias voltage is available on AIN1.
0	VBIAS0	Enable the bias voltage on the AIN0 channel. When set, the internal bias voltage is available on AIN0.

### ID REGISTER

**RS[5:0] = 0, 0, 0, 1, 0, 1 Power-On/Reset = 0x17**

The identification number for the [ADFS7124-8](#) is stored in the ID register. This is a read only register.

### ERROR REGISTER

**RS[5:0] = 0, 0, 0, 1, 1, 0**

**Power-On/Reset = 0x000000**

## ON-CHIP REGISTERS

Diagnostics, such as checking overvoltages and checking the SPI, are included on the ADFS7124-8. The error register contains the flags for the different diagnostic functions. The functions are enabled and disabled using the ERROR\_EN register.

Table 70 outlines the bit designations for the register. Bit 23 is the first bit of the data stream. The number in parentheses indicates the power-on/reset default status of that bit.

Bit 7	Bit 6	Bit 5	Bit 4	Bit 3	Bit 2	Bit 1	Bit 0
		0 (0)		LDO_CAP_ERR (0)	ADC_CAL_ERR (0)	ADC_CONV_ERR (0)	ADC_SAT_ERR (0)
AINP_OV_ERR (0)	AINP_UV_ERR (0)	AINM_OV_ERR (0)	AINM_UV_ERR (0)	REF_DET_ERR (0)	0 (0)	DLDO_PSM_ERR (0)	0 (0)
ALDO_PSM_ERR (0)	SPI_IGNORE_ERR (0)	SPI_SCLK_CNT_ERR (0)	SPI_READ_ERR (0)	SPI_WRITE_ERR (0)	SPI_CRC_ERR (0)	MM_CRC_ERR (0)	ROM_CRC_ERR (0)

**Table 70. Error Register Bit Descriptions**

Bits	Bit Name	Description
23:20	0	These bits must be programmed with a Logic 0 for correct operation.
19	LDO_CAP_ERR	Analog/digital LDO decoupling capacitor check. This flag is set if the decoupling capacitors required for the analog and digital LDOs are not connected to the ADFS7124-8. Note that a missing decoupling capacitor can cause the ADC to reset. However, this is easily detectable at the system level.
18	ADC_CAL_ERR	Calibration check. If a calibration is initiated but not completed, this flag is set to indicate that an error occurred during the calibration. The associated calibration register is not updated.
17	ADC_CONV_ERR	This bit indicates whether a conversion is valid. This flag is set if an error occurs during a conversion.
16	ADC_SAT_ERR	ADC saturation flag. This flag is set if the modulator is saturated during a conversion.
15	AINP_OV_ERR	Overvoltage detection on AINP.
14	AINP_UV_ERR	Undervoltage detection on AINP.
13	AINM_OV_ERR	Overvoltage detection on AINM.
12	AINM_UV_ERR	Undervoltage detection on AINM.
11	REF_DET_ERR	Reference detection. This flag indicates when the external reference being used by the ADC is open circuit or less than 0.7 V.
10	0	This bit must be programmed with a Logic 0 for correct operation.
9	DLDO_PSM_ERR	Digital LDO error. This flag is set if an error is detected with the digital LDO.
8	0	This bit must be programmed with a Logic 0 for correct operation.
7	ALDO_PSM_ERR	Analog LDO error. This flag is set if an error is detected with the analog LDO voltage.
6	SPI_IGNORE_ERR	During power-on reset and calibrations, the on-chip registers cannot be written to. User write instructions are ignored by the ADC. This bit is set, indicating that the ADC is busy and the write instruction has been ignored. The SPI_IGNORE_ERR bit is cleared when read.
5	SPI_SCLK_CNT_ERR	All serial communications are some multiple of eight bits. This bit is set when the number of SCLK cycles is not a multiple of eight.
4	SPI_READ_ERR	This bit is set when an error occurs during an SPI read operation.
3	SPI_WRITE_ERR	This bit is set when an error occurs during an SPI write operation.
2	SPI_CRC_ERR	This bit is set if an error occurs in the CRC check of the serial communications.
1	MM_CRC_ERR	Memory map error. A CRC calculation is performed on the memory map each time that the registers are written to. Following this, periodic CRC checks are performed on the on-chip registers. If the register contents have changed, the MM_CRC_ERR bit is set.
0	ROM_CRC_ERR	ROM error. A CRC calculation is performed on the ROM contents (contains the default register values) on power-up. If the contents have changed, the ROM_CRC_ERR bit is set.

## ERROR\_EN REGISTER

**RS[5:0] = 0, 0, 0, 1, 1, 1**

**Power-On/Reset = 0x000040**

All the diagnostic functions can be enabled or disabled by setting the appropriate bits in this register.

Table 71 outlines the bit designations for the register. Bit 23 is the first bit of the data stream. The number in parentheses indicates the power-on/reset default status of that bit.

## ON-CHIP REGISTERS

Bit 7	Bit 6	Bit 5	Bit 4	Bit 3	Bit 2	Bit 1	Bit 0
0 (0)	MCLK_CNT_EN (0)	LDO_CAP_CHK_TEST_EN (0)	LDO_CAP_CHK (0)		ADC_CAL_ERR_EN (0)	ADC_CONV_ERR_EN (0)	ADC_SAT_ERR_EN (0)
AINP_OV_ERR_EN (0)	AINP_UV_ERR_EN (0)	AINM_OV_ERR_EN (0)	AINM_UV_ERR_EN (0)	REF_DET_ERR_EN (0)	DLDO_PSM_TRIP_TEST_EN (0)	DLDO_PSM_ERR_EN (0)	ALDO_PSM_TRIP_TEST_EN (0)
ALDO_PSM_ERR_EN (0)	SPI_IGNORE_ERR_EN (1)	SPI_SCLK_CNT_ERR_EN (0)	SPI_READ_ERR_EN (0)	SPI_WRITE_ERR_EN (0)	SPI_CRC_ERR_EN (0)	MM_CRC_ERR_EN (0)	ROM_CRC_ERR_EN (0)

Table 71. ERROR\_EN Register Bit Descriptions

Bits	Bit Name	Description
23	0	This bit must be programmed with a Logic 0 for correct operation.
22	MCLK_CNT_EN	Controller clock counter. When this bit is set, the controller clock counter is enabled and the result is reported through the MCLK_COUNT register. The counter monitors the controller clock being used by the ADC. If an external clock is the clock source, the MCLK counter monitors this external clock. Similarly, if the on-chip oscillator is selected as the clock source to the ADC, the MCLK counter monitors the on-chip oscillator.
21	LDO_CAP_CHK_TEST_EN	Test of analog/digital LDO decoupling capacitor check. When this bit is set, the decoupling capacitor is internally disconnected from the LDO, forcing a fault condition. This allows the user to test the circuitry that is used for the analog and digital LDO decoupling capacitor check.
20:19	LDO_CAP_CHK	Analog/digital LDO decoupling capacitor check. These bits enable the capacitor check. When a check is enabled, the ADC checks for the presence of the external decoupling capacitor on the selected supply. When the check is complete, the LDO_CAP_CHK bits are both reset to 0. Note that a missing decoupling capacitor can cause the ADC to reset. However, a missing capacitor is easily detectable at the system level. 00 = check is not enabled. 01 = check the analog LDO capacitor. 10 = check the digital LDO capacitor. 11 = check is not enabled.
18	ADC_CAL_ERR_EN	When this bit is set, the calibration fail check is enabled.
17	ADC_CONV_ERR_EN	When this bit is set, the conversions are monitored and the ADC_CONV_ERR bit is set when a conversion fails.
16	ADC_SAT_ERR_EN	When this bit is set, the ADC modulator saturation check is enabled.
15	AINP_OV_ERR_EN	When this bit is set, the overvoltage monitor on all enabled AINP channels is enabled.
14	AINP_UV_ERR_EN	When this bit is set, the undervoltage monitor on all enabled AINP channels is enabled.
13	AINM_OV_ERR_EN	When this bit is set, the overvoltage monitor on all enabled AINM channels is enabled.
12	AINM_UV_ERR_EN	When this bit is set, the undervoltage monitor on all enabled AINM channels is enabled.
11	REF_DET_ERR_EN	When this bit is set, any external reference being used by the ADC is continuously monitored. An error is flagged if the external reference is open circuit or has a value of less than 0.7 V.
10	DLDO_PSM_TRIP_TEST_EN	Checks the test mechanism that monitors the digital LDO. When this bit is set, the input to the test circuit is tied to DGND instead of the LDO output. Set the DLDO_PSM_ERR bit in the error register.
9	DLDO_PSM_ERR_ERR_EN	When this bit is set, the digital LDO voltage is continuously monitored. The DLDO_PSM_ERR bit in the error register is set if the voltage being output from the digital LDO is outside specification.
8	ALDO_PSM_TRIP_TEST_EN	Checks the test mechanism that monitors the analog LDO. When this bit is set, the input to the test circuit is tied to AV <sub>SS</sub> instead of the LDO output. Set the ALDO_PSM_ERR bit in the error register.
7	ALDO_PSM_ERR_EN	When this bit is set, the analog LDO voltage is continuously monitored. The ALDO_PSM_ERR bit in the error register is set if the voltage being output from the analog LDO is outside specification.
6	SPI_IGNORE_ERR_EN	During power-on reset and calibrations, the on-chip registers cannot be written to. User write instructions are ignored by the ADC. Set this bit so that the SPI_IGNORE_ERR bit in the error register informs when write operations are ignored.
5	SPI_SCLK_CNT_ERR_EN	When this bit is set, the SCLK counter is enabled. All read and write operations to the ADC are multiples of eight bits. For every serial communication, the SCLK counter counts the number of SCLK pulses. $\overline{CS}$ must be used to frame each read and write operation. If the number of SCLK pulses used during a communication is not a multiple of eight, the SPI_SCLK_CNT_ERR bit in the error register is set. For example, a glitch on the SCLK pin during a read or write operation can be interpreted as an SCLK pulse. In this case, the SPI_SCLK_CNT_ERR bit is set as there is an excessive number of SCLK pulses detected. $\overline{CS}_{EN}$ in the ADC_CONTROL register must be set to 1 when the SCLK counter function is being used.



## ON-CHIP REGISTERS

Table 71. ERROR\_EN Register Bit Descriptions (Continued)

Bits	Bit Name	Description
4	SPI_READ_ERR_EN	When this bit is set, the SPI_READ_ERR bit in the error register is set when an error occurs during a read operation. An error occurs if there is an attempt to read from invalid addresses. $\overline{CS\_EN}$ in the ADC_CONTROL register must be set to 1 when the SPI read check function is being used.
3	SPI_WRITE_ERR_EN	When this bit is set, the SPI_WRITE_ERR bit in the error register is set when an error occurs during a write operation. An error occurs if there is an attempt to write to invalid addresses or write to read-only registers. $\overline{CS\_EN}$ in the ADC_CONTROL register must be set to 1 when the SPI write check function is being used.
2	SPI_CRC_ERR_EN	This bit enables a CRC check of all read and write operations. The SPI_CRC_ERR bit in the error register is set if the CRC check fails. In addition, an 8-bit CRC word is appended to all data read from the ADFS7124-8.
1	MM_CRC_ERR_EN	When this bit is set, a CRC calculation is performed on the memory map each time that the registers are written to. Following this, periodic CRC checks are performed on the on-chip registers. If the register contents have changed, the MM_CRC_ERR bit is set.
0	ROM_CRC_ERR_EN	When this bit is set, a CRC calculation is performed on the ROM contents on power-on. If the ROM contents have changed, the ROM_CRC_ERR bit is set.

## MCLK\_COUNT REGISTER

RS[5:0] = 0, 0, 1, 0, 0, 0

Power-On/Reset = 0x00

The controller clock frequency can be monitored using this register.

Table 72 outlines the bit designations for the register. Bit 7 is the first bit of the data stream. The number in parentheses indicates the power-on/reset default status of that bit.

Bit 7	Bit 6	Bit 5	Bit 4	Bit 3	Bit 2	Bit 1	Bit 0
MCLK_COUNT (0)							

Table 72. MCLK\_COUNT Register Bit Descriptions

Bits	Bit Name	Description
7:0	MCLK_COUNT	This register allows the user to determine the frequency of the internal/external oscillator. Internally, a clock counter increments every 131 pulses of the sampling clock (614.4 kHz in the full power mode, 153.6 kHz in the mid power mode, and 768 kHz in the low power mode). The 8-bit counter wraps around on reaching its maximum value. The counter output is read back through this register.  Note that the incrementation of the register is asynchronous to the register read. If a register read coincides with the register incrementation, it is possible to read an invalid value. To prevent this, read the register four times rather than once, then read the register four times again at a later point. By reading four values, it is possible to identify the correct register value at the start and at the end of the timing instants.

## CHANNEL REGISTERS

RS[5:0] = 0, 0, 1, 0, 0, 1 to 0, 1, 1, 0, 0, 0

Power-On/Reset = 0x8001 for CHANNEL\_0; all other channel registers are set to 0x0001

Sixteen channel registers are included on the ADFS7124-8, CHANNEL\_0 to CHANNEL\_15. The channel registers begin at Address 0x09 (CHANNEL\_0) and end at Address 0x18 (CHANNEL\_15). Through each register, configure the channel (AINP input and AINM input), enable or disable the channel, and select the setup. The setup is selectable from eight different options. When the ADC converts, it automatically sequences through all enabled channels. This allows the user to sample some channels multiple times in a sequence, if required. In addition, it allows the user to include diagnostic functions in a sequence also.

Table 73 outlines the bit designations for the register. Bit 15 is the first bit of the data stream. The number in parentheses indicates the power-on/reset default status of that bit.

Bit 7	Bit 6	Bit 5	Bit 4	Bit 3	Bit 2	Bit 1	Bit 0
Enable (1)	Setup (0)			(0)	0 (0)	AINP[4:3] (00)	
AINP[2:0] (000)				AINM[4:0] (00001)			

## ON-CHIP REGISTERS

Table 73. Channel Register Bit Descriptions

Bits	Bit Name	Description
15	Enable	<p>Channel enable bit. Setting this bit enables the device channel for the conversion sequence. By default, only the enable bit for Channel 0 is set. The order of conversions starts with the lowest enabled channel, then cycles through successively higher channel numbers, before wrapping around to the lowest channel again.</p> <p>When the ADC writes a result for a particular channel, the four LSBs of the status register are set to the channel number, 0 to 15. This allows the channel the data corresponds to be identified. When the DATA_STATUS bit in the ADC_CONTROL register is set, the contents of the status register are appended to each conversion when it is read. Use this function when several channels are enabled to determine to which channel the conversion value read corresponds.</p>
14:12	Setup	Setup select. These bits identify which of the eight setups are used to configure the ADC for this channel. A setup comprises a set of four registers: analog configuration, output data rate/filter selection, offset register, and gain register. All channels can use the same setup, in which case the same 3-bit value must be written to these bits on all active channels. Alternatively, up to eight channels can be configured differently.
11:10	0	These bits must be programmed with a Logic 0 for correct operation.
9:5	AINP[4:0]	<p>Positive analog input AINP input select. These bits select which of the analog inputs is connected to the positive input for this channel.</p> <p>00000 = AIN0 (default).  00001 = AIN1.  00010 = AIN2.  00011 = AIN3.  00100 = AIN4.  00101 = AIN5.  00110 = AIN6.  00111 = AIN7.  01000 = AIN8.  01001 = AIN9.  01010 = AIN10.  01011 = AIN11.  01100 = AIN12.  01101 = AIN13.  01110 = AIN14.  01111 = AIN15.  10000 = temperature sensor.  10001 = AV<sub>SS</sub>.  10010 = internal reference.  10011 = DGND.  10100 = (AV<sub>DD</sub> - AV<sub>SS</sub>)/6+. Use in conjunction with (AV<sub>DD</sub> - AV<sub>SS</sub>)/6- to monitor supply AV<sub>DD</sub> - AV<sub>SS</sub>.  10101 = (AV<sub>DD</sub> - AV<sub>SS</sub>)/6-. Use in conjunction with (AV<sub>DD</sub> - AV<sub>SS</sub>)/6+ to monitor supply AV<sub>DD</sub> - AV<sub>SS</sub>.  10110 = (IOV<sub>DD</sub> - DGND)/6+. Use in conjunction with (IOV<sub>DD</sub> - DGND)/6- to monitor IOV<sub>DD</sub> - DGND.  10111 = (IOV<sub>DD</sub> - DGND)/6-. Use in conjunction with (IOV<sub>DD</sub> - DGND)/6+ to monitor IOV<sub>DD</sub> - DGND.  11000 = (ALDO - AV<sub>SS</sub>)/6+. Use in conjunction with (ALDO - AV<sub>SS</sub>)/6- to monitor the analog LDO.  11001 = (ALDO - AV<sub>SS</sub>)/6-. Use in conjunction with (ALDO - AV<sub>SS</sub>)/6+ to monitor the analog LDO.  11010 = (DLDO - DGND)/6+. Use in conjunction with (DLDO - DGND)/6- to monitor the digital LDO.  11011 = (DLDO - DGND)/6-. Use in conjunction with (DLDO - DGND)/6+ to monitor the digital LDO.  11100 = V_20MV_P. Use in conjunction with V_20MV_M to apply a 20 mV p-p signal to the ADC.  11101 = V_20MV_M. Use in conjunction with V_20MV_P to apply a 20 mV p-p signal to the ADC.  11110 = Reserved.  11111 = Reserved.</p>
4:0	AINM[4:0]	<p>Negative analog input AINM input select. These bits select which of the analog inputs is connected to the negative input for this channel.</p> <p>00000 = AIN0.  00001 = AIN1 (default).  00010 = AIN2.</p>

## ON-CHIP REGISTERS

Table 73. Channel Register Bit Descriptions (Continued)

Bits	Bit Name	Description
		00011 = AIN3.
		00100 = AIN4.
		00101 = AIN5.
		00110 = AIN6.
		00111 = AIN7.
		01000 = AIN8.
		01001 = AIN9.
		01010 = AIN10.
		01011 = AIN11.
		01100 = AIN12.
		01101 = AIN13.
		01110 = AIN14.
		01111 = AIN15.
		10000 = temperature sensor.
		10001 = AV <sub>SS</sub> .
		10010 = internal reference.
		10011 = DGND.
		10100 = (AV <sub>DD</sub> - AV <sub>SS</sub> )/6+. Use in conjunction with (AV <sub>DD</sub> - AV <sub>SS</sub> )/6- to monitor supply AV <sub>DD</sub> - AV <sub>SS</sub> .
		10101 = (AV <sub>DD</sub> - AV <sub>SS</sub> )/6-. Use in conjunction with (AV <sub>DD</sub> - AV <sub>SS</sub> )/6+ to monitor supply AV <sub>DD</sub> - AV <sub>SS</sub> .
		10110 = (IOV <sub>DD</sub> - DGND)/6+. Use in conjunction with (IOV <sub>DD</sub> - DGND)/6- to monitor IOV <sub>DD</sub> - DGND.
		10111 = (IOV <sub>DD</sub> - DGND)/6-. Use in conjunction with (IOV <sub>DD</sub> - DGND)/6+ to monitor IOV <sub>DD</sub> - DGND.
		11000 = (ALDO - AV <sub>SS</sub> )/6+. Use in conjunction with (ALDO - AV <sub>SS</sub> )/6- to monitor the analog LDO.
		11001 = (ALDO - AV <sub>SS</sub> )/6-. Use in conjunction with (ALDO - AV <sub>SS</sub> )/6+ to monitor the analog LDO.
		11010 = (DLDO - DGND)/6+. Use in conjunction with (DLDO - DGND)/6- to monitor the digital LDO.
		11011 = (DLDO - DGND)/6-. Use in conjunction with (DLDO - DGND)/6+ to monitor the digital LDO.
		11100 = V_20MV_P. Use in conjunction with V_20MV_M to apply a 20 mV p-p signal to the ADC.
		11101 = V_20MV_M. Use in conjunction with V_20MV_P to apply a 20 mV p-p signal to the ADC.
		11110 = Reserved.
		11111 = Reserved.

## CONFIGURATION REGISTERS

RS[5:0] = 0, 1, 1, 0, 0, 1 to 1, 0, 0, 0, 0, 0

Power-On/Reset = 0x0860

The ADFS7124-8 has eight configuration registers, CONFIG\_0 to CONFIG\_7. Each configuration register is associated with a setup; CONFIG\_x is associated with Setup x. In the configuration register, the reference source, polarity, reference buffers are configured. Table 74 outlines the bit designations for the register. Bit 15 is the first bit of the data stream. The number in parentheses indicates the power-on/ reset default status of that bit.

Bit 7	Bit 6	Bit 5	Bit 4	Bit 3	Bit 2	Bit 1	Bit 0
		0 (0)		Bipolar (1)		Burnout (0)	REF_BUFP (0)
REF_BUFM (0)	AIN_BUFPP (1)	AIN_BUFPM (1)		REF_SEL (0)		PGA (0)	

Table 74. Configuration Register Bit Descriptions

Bits	Bit Name	Description
15:12	0	These bits must be programmed with a Logic 0 for correct operation.
11	Bipolar	Polarity select bit. When this bit is set, bipolar operation is selected. When this bit is cleared, unipolar operation is selected.
10:9	Burnout	These bits select the magnitude of the sensor burnout detect current source.

## ON-CHIP REGISTERS

Table 74. Configuration Register Bit Descriptions (Continued)

Bits	Bit Name	Description	
		00 = burnout current source off (default). 01 = burnout current source on, 0.5 $\mu$ A. 10 = burnout current source on, 2 $\mu$ A. 11 = burnout current source on, 4 $\mu$ A.	
8	REF_BUFPP	Buffer enable on REFINx(+). When this bit is set, the positive reference input (internal or external) is buffered. When this bit is cleared, the positive reference input (internal or external) is unbuffered.	
7	REF_BUFNM	Buffer enable on REFINx(-). When this bit is set, the negative reference input (internal or external) is buffered. When this bit is cleared, the negative reference input (internal or external) is unbuffered.	
6	AIN_BUFPP	Buffer enable on AINP. When this bit is set, the selected positive analog input pin is buffered. When this bit is cleared, the selected positive analog input pin is unbuffered.	
5	AIN_BUFNM	Buffer enable on AINM. When this bit is set, the selected negative analog input pin is buffered. When this bit is cleared, the selected negative analog input pin is unbuffered.	
4:3	REF_SEL	Reference source select bits. These bits select the reference source to use when converting on any channels using this configuration register. 00 = REF1N1(+)/REF1N1(-). 01 = REF1N2(+)/REF1N2(-). 10 = internal reference. 11 = AV <sub>DD</sub> .	
2:0	PGA	Gain select bits. These bits select the gain to use when converting on any channels using this configuration register.	
	<b>PGA</b>	<b>Gain</b>	
		<b>Input Range When V<sub>REF</sub> = 2.5 V (Bipolar Mode)</b>	
	000	1	$\pm$ 2.5 V
	001	2	$\pm$ 1.25 V
	010	4	$\pm$ 625 mV
	011	8	$\pm$ 312.5 mV
	100	16	$\pm$ 156.25 mV
	101	32	$\pm$ 78.125 mV
	110	64	$\pm$ 39.06 mV
	111	128	$\pm$ 19.53 mV

## FILTER REGISTERS

RS[5:0] = 1, 0, 0, 0, 0, 1 to 1, 0, 1, 0, 0, 0

Power-On/Reset = 0x060180

The ADFS7124-8 has eight filter registers, FILTER\_0 to FILTER\_7. Each filter register is associated with a setup; FILTER\_x is associated with Setup x. In the filter register, the filter type and output word rate are set.

Table 75 outlines the bit designations for the register. Bit 15 is the first bit of the data stream. The number in parentheses indicates the power-on/reset default status of that bit.

Bit 7	Bit 6	Bit 5	Bit 4	Bit 3	Bit 2	Bit 1	Bit 0
	Filter (0)		REJ60(0)		POST_FILTER(0)		SINGLE_CYCLE(0)
		0(0)				FS[10:8](0)	
				FS[7:0](0)			

Table 75. Filter Register Bit Descriptions

Bits	Bit Name	Description
23:21	Filter	Filter type select bits. These bits select the filter type. 000 = sinc <sup>4</sup> filter (default). 001 = reserved. 010 = sinc <sup>3</sup> filter.

## ON-CHIP REGISTERS

Table 75. Filter Register Bit Descriptions (Continued)

Bits	Bit Name	Description																											
		011 = reserved. 100 = fast settling filter using the sinc <sup>4</sup> filter. The sinc <sup>4</sup> filter is followed by an averaging block, which results in a settling time equal to the conversion time. In full power and mid power modes, averaging by 16 occurs whereas averaging by 8 occurs in low power mode. 101 = fast settling filter using the sinc <sup>3</sup> filter. The sinc <sup>3</sup> filter is followed by an averaging block, which results in a settling time equal to the conversion time. In full power and mid power modes, averaging by 16 occurs whereas averaging by 8 occurs in low power mode. 110 = reserved. 111 = post filter enabled. The ADFS7124-8 includes several post filters, selectable using the POST_FILTER bits. The post filters have single cycle settling, the settling time being considerably better than a simple sinc <sup>3</sup> /sinc <sup>4</sup> filter. These filters offer excellent 50 Hz and 60 Hz rejection.																											
20	REJ60	When this bit is set, a first order notch is placed at 60 Hz when the first notch of the sinc filter is at 50 Hz. This allows simultaneous 50 Hz and 60 Hz rejection.																											
19:17	POST_FILTER	Post filter type select bits. When the filter bits are set to 1, the sinc <sup>3</sup> filter is followed by a post filter that offers good 50 Hz and 60 Hz rejection at output data rates that have zero latency approximately.																											
		<table border="1"> <thead> <tr> <th>POST_FILTER</th> <th>Output Data Rate (SPS)</th> <th>Rejection at 50 Hz and 60 Hz ± 1 Hz (dB)</th> </tr> </thead> <tbody> <tr> <td>000</td> <td>Reserved</td> <td>Not applicable</td> </tr> <tr> <td>010</td> <td>Reserved</td> <td>Not applicable</td> </tr> <tr> <td>010</td> <td>27.27</td> <td>47</td> </tr> <tr> <td>011</td> <td>25</td> <td>62</td> </tr> <tr> <td>100</td> <td>Reserved</td> <td>Not applicable</td> </tr> <tr> <td>101</td> <td>20</td> <td>86</td> </tr> <tr> <td>110</td> <td>16.7</td> <td>92</td> </tr> <tr> <td>111</td> <td>Reserved</td> <td>Not applicable</td> </tr> </tbody> </table>	POST_FILTER	Output Data Rate (SPS)	Rejection at 50 Hz and 60 Hz ± 1 Hz (dB)	000	Reserved	Not applicable	010	Reserved	Not applicable	010	27.27	47	011	25	62	100	Reserved	Not applicable	101	20	86	110	16.7	92	111	Reserved	Not applicable
POST_FILTER	Output Data Rate (SPS)	Rejection at 50 Hz and 60 Hz ± 1 Hz (dB)																											
000	Reserved	Not applicable																											
010	Reserved	Not applicable																											
010	27.27	47																											
011	25	62																											
100	Reserved	Not applicable																											
101	20	86																											
110	16.7	92																											
111	Reserved	Not applicable																											
16	SINGLE_CYCLE	Single cycle conversion enable bit. When this bit is set, the ADFS7124-8 settles in one conversion cycle so that it functions as a zero latency ADC. This bit has no effect when multiple analog input channels are enabled or when the single conversion mode is selected. When the fast filters are used, this bit has no effect.																											
15:11	0	These bits must be programmed with a Logic 0 for correct operation.																											
10:0	FS[10:0]	Filter output data rate select bits. These bits set the output data rate of the sinc <sup>3</sup> filter, sinc <sup>4</sup> filter, and fast settling filters. In addition, they affect the position of the first notch of the sinc filter and the cutoff frequency. In association with the gain selection, they also determine the output noise and, therefore, the effective resolution of the device (see noise tables). FS can have a value from 1 to 2047.																											

## OFFSET REGISTERS

RS[5:0] = 1, 0, 1, 0, 0, 1 to 1, 1, 0, 0, 0, 0

Power-On/Reset = 0x800000

The ADFS7124-8 has eight offset registers, OFFSET\_0 to OFFSET\_7. Each offset register is associated with a setup; OFFSET\_x is associated with Setup x. The offset registers are 24-bit registers and hold the offset calibration coefficient for the ADC and its power-on reset value is 0x800000. Each of these registers is a read/write register. These registers are used in conjunction with the associated gain register to form a register pair. The power-on reset value is automatically overwritten if an internal or system zero-scale calibration is initiated. The ADC must be placed in the standby mode or idle mode when writing to the offset registers.

## GAIN REGISTERS

RS[5:0] = 1, 1, 0, 0, 0, 1 to 1, 1, 1, 0, 0, 0

Power-On/Reset = 0x5XXXXX

The ADFS7124-8 has eight gain registers, GAIN\_0 to GAIN\_7. Each gain register is associated with a setup; GAIN\_x is associated with Setup x. The gain registers are 24-bit registers and hold the full-scale calibration coefficient for the ADC. The ADFS7124-8 is factory calibrated to a gain of 1. The gain register contains this factory generated value on power-on and after a reset. The gain registers are read/write registers. However, when writing to the registers, the ADC must be placed in the standby mode or idle mode. The default value is automatically overwritten if an internal or system full-scale calibration is initiated or the full-scale registers are written to.

OUTLINE DIMENSIONS

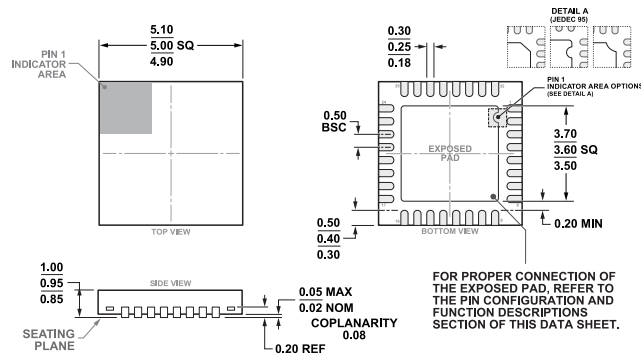

COMPLIANT TO JEDEC STANDARDS MO-220-VHHD-5

**Figure 129. 32-Lead Lead Frame Chip Scale Package [LFCSP]  
5 mm × 5 mm Body and 0.95 mm Package Height  
(CP-32-30)  
Dimensions shown in millimeters**

ORDERING GUIDE

Model <sup>1</sup>	Temperature Range	Package Description	Package Option
ADFS7124-8BBCPZ	-40°C to +125°C	32-Lead Lead Frame Chip Scale Package [LFCSP]	CP-32-30
ADFS7124-8BBCPZ-RL7	-40°C to +125°C	32-Lead Lead Frame Chip Scale Package [LFCSP]	CP-32-30

<sup>1</sup> Z = RoHS Compliant Part.